



VISUAL COMFORT  
& Co. Est. 1987





VISUAL COMFORT & Co. Est. 1987



THE PRIMARY RESOURCE

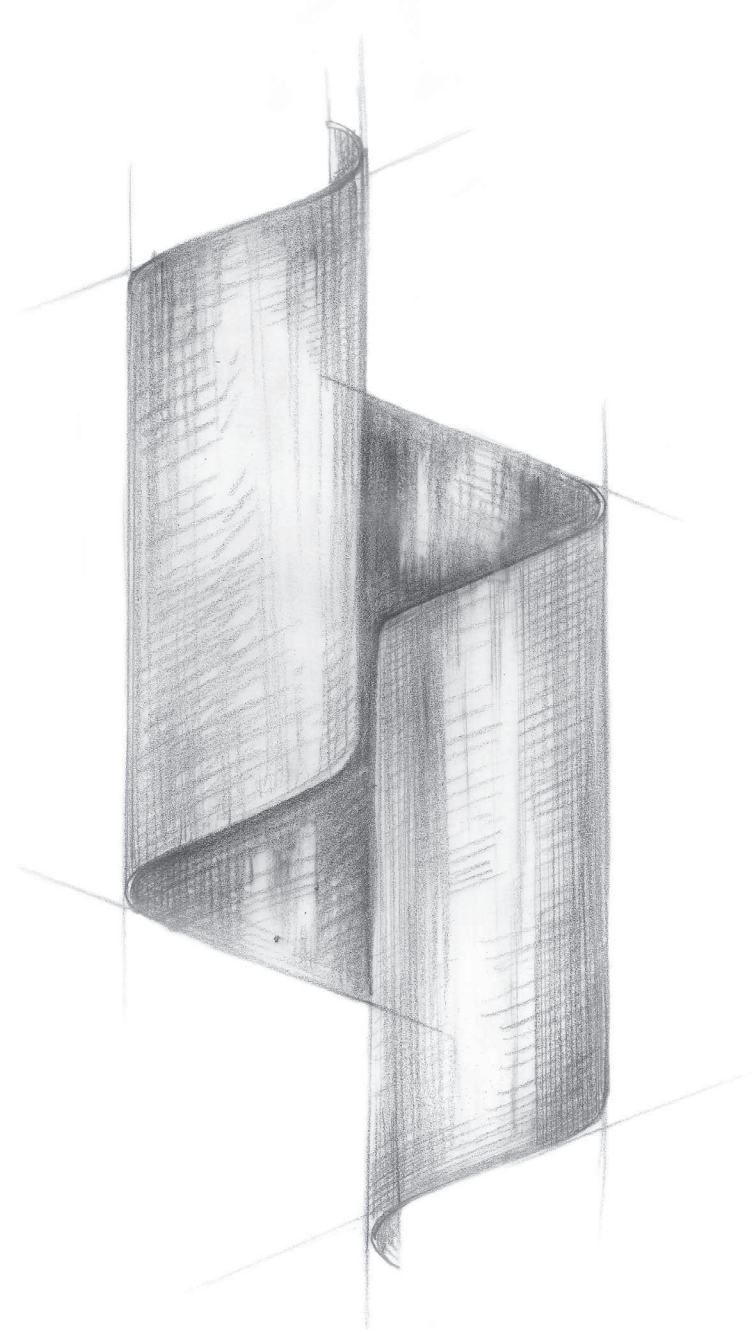

FOR ALL YOUR DECORATIVE LIGHTING NEEDS



DESIGN + MANUFACTURING





THE SKILL OF MANY COLLABORATORS GOES INTO THE CREATION OF EVERY LIGHT. THE IVEALA SINGLE SCONCE BY AERIN MOVES THROUGH DOZENS OF STAGES TO ARRIVE AT ITS FINAL FORM, FROM INITIAL DRAWINGS THROUGH WORKSHOP PROTOTYPES. THIS DECEPTIVELY SIMPLE, NATURAL ALABASTER DISC IS THEN CHISELED AND POLISHED TO PERFECTION.

## WE CREATE ORIGINAL LIGHTING

Throughout our history, we've taken pride in creating lighting from start to finish. We design our products; source and develop our materials; invent new processes; produce every part; and, manufacture every light, down to the last fitting and detail.

This full life cycle gives us more control and creative license for a better, original product. We have the expertise to choose the best methods; the industry leadership to work with the foremost designers; the scale and dedication to make premium decorative lighting that has the quality and character of bespoke design. We are involved every step of the way.



## UNPARALLELED DESIGN

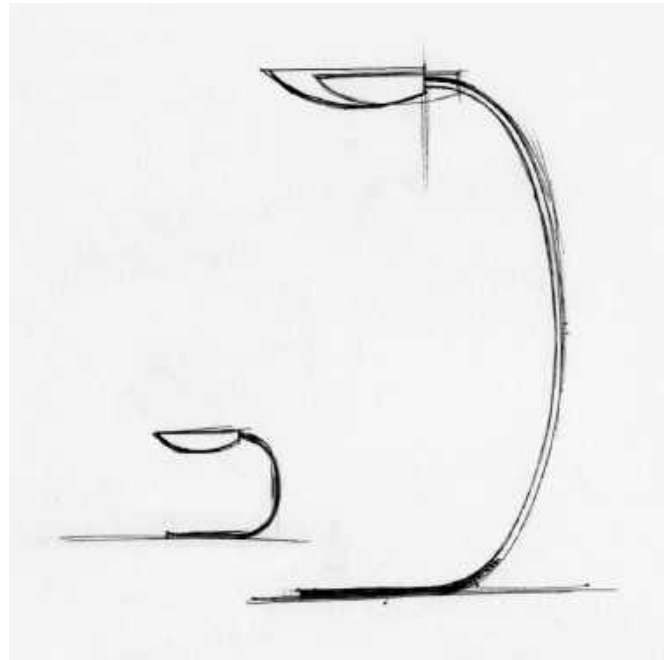

### ONE SHAPE, MULTIPLE FORMS.

THE LOLA COLLECTION BY IAN K. FOWLER IS ONE OF MANY FAMILIES WITH LIGHTS THAT WORK TOGETHER SEAMLESSLY ACROSS THE ROOM PLAN—FROM TABLE AND FLOOR LAMPS TO CEILING AND WALL FIXTURES. THIS DESIGN CONTINUITY MAKES SELECTION EASY AND IS A KEY FACTOR IN HOW WE DEVELOP OUR PRODUCTS.

WITH ITS DISTINCTIVE CURVED AND ELLIPTICAL METAL SHADE, LOLA SUGGESTS A COLLECTION OF ORGANIC CREATURES WHEN GROUPED TOGETHER. ENVISIONED THROUGH A MODERNIST LENS, WITH MINIMAL TUBULAR BASES, THE DESIGN ELIMINATES THE EXTRANEIOUS IN FAVOR OF PURE LINES AND A LIQUID GLOW IN BURNISHED BRASS.





## IMPECCABLE MANUFACTURING

### TECHNICAL MASTERY, MANY TECHNIQUES.

WE ACHIEVE INCREDIBLE DESIGN DETAILS THROUGH OUR SELECTIVE PRODUCTION PROCESSES. WE APPLY A HIGH LEVEL OF CUSTOMIZATION TO EVERY TECHNIQUE WE EMPLOY, FROM METALWORKING TO CARVING, LATHE TURNING TO LASER CUTTING, GLASS BLOWING AND CRYSTAL MAKING TO CREATING HAND-RUBBED METAL PATINAS AND GILDED SURFACES.

LEFT TO RIGHT:  
THE VERSA LAMP BY JULIE NEILL IS SMOOTHLY SCULPTED OF TRANSLUCENT ALABASTER INTO PERFECTLY BALANCED GEOMETRIC SHAPES. THE LIAISON SERIES BY KELLY WEARSTLER HIGHLIGHTS THE TECHNICAL PRECISION OF OUR UNIQUE CRACKLE GLASS WITHIN CLEAN ARCHITECTURAL METAL CASINGS. THE MIXED METAL FINISHES OF THE ALBORG PENDANT LIGHT BY E.F. CHAPMAN OFFER TONAL OR CONTRASTING DETAIL, IN DARK TO LIGHT EXPRESSIONS. OUR EXCLUSIVE HAND-RUBBED ANTIQUE NICKEL IS A PARTICULARLY RARE FINISH. THE SPECIALIZED CHAIN ADDS INDIVIDUALITY WITH ITS ALTERNATING OVAL AND ROUND LINKS. AN ARTISAN AT OUR FACTORY POURS MOLTEN BRASS INTO A CUSTOM SAND-CAST MOLD TO MAKE A PROPRIETARY COMPONENT FOR ONE OF OUR LIGHTS.







CRAFTSMANSHIP + TECHNOLOGY

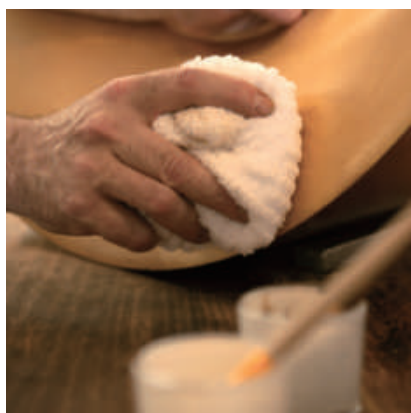
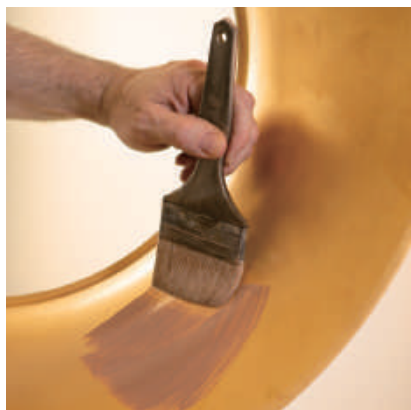

### **WE ENGAGE ARTISANS AND INNOVATORS**

We believe that craft is the key ingredient to making extraordinary lighting. It's what links us to the heritage of rich, natural materials—metal, wood, stone, glass, crystal, ceramic—with time-honored techniques to shape them into a world of different forms. Continuing those traditions is why we focus so much on the craftsmanship and artisanal finishes of all our products.

At the same time, we're always embracing technology that advances new possibilities for our craft. Lighting design is rapidly evolving today with compelling methods and innovative applications. We're inspired to offer the most current advancements in order to make new lighting experiences both accessible and beautiful.

FOR THE HALO HANGING SHADE BY BARBARA BARRY, EACH UNIQUE FORM IS HAND-GILDED, ANTIQUED, AND SEALED TO CREATE A LASTING, TIMELESS FINISH. OUR DEDICATION TO CRAFT AND TECHNICAL MASTERY ALLOWS US TO CONTINUALLY DEVELOP AND MAKE SUPERIOR LIGHTING.



# AUTHENTIC CRAFTSMANSHIP



## SKILLED ARTISANS, FINE WORKMANSHIP.

EVERY MATERIAL WE USE IS MADE MORE SPECIAL WITH ATTENTIVE CRAFT. THIS CARE SHOWS IN THE ARRAY OF FINE FINISHES THAT OUR LIGHTING BRINGS TO ARTFUL INTERIORS.

LEFT TO RIGHT: MARRYING TRADITION AND TECHNOLOGY, HAND-RUBBED GILDED IRON WARMS THE LASER-CUT SUNBURST FORMS OF THE CLAYMORE COLLECTION BY E.F. CHAPMAN. THE LORFORD BELL LANTERN, ALSO BY E.F. CHAPMAN, CELEBRATES THE VINTAGE BEAUTY OF ANTIQUE-FABRICATED MERCURY GLASS. THE PAPER MOON SERIES BY BARBARA BARRY MAKES EXPRESSIVE MODERN SHADES OUT OF SIMPLE RICE PAPER, METICULOUSLY WRAPPED ON FINE WIRE FRAMES. THE ADELINE LARGE QUATREFOIL TABLE LAMP BY SUZANNE KASLER TRANSFORMS A PLAIN ALABASTER PILLAR INTO A GRACEFULLY CARVED FORM IN-THE-ROUND, WITH A CLASSICAL PROFILE AND SLENDER METAL FITTINGS.



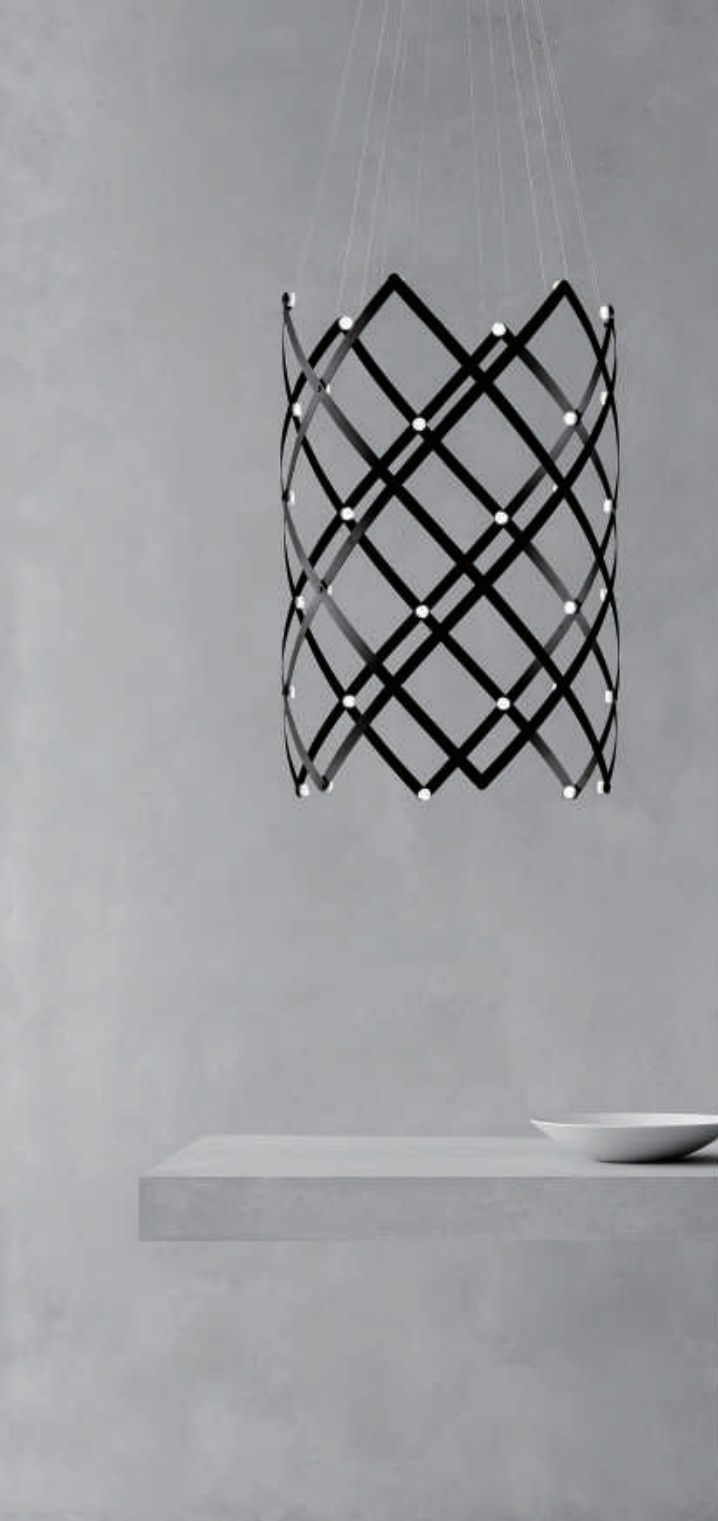

**NEW ENGINEERING, CREATIVE SOLUTIONS.**

MODERN *LED* TECHNOLOGY AND NEW INDUSTRIAL MATERIALS REINVENT HOW THE LIGHT SOURCE CAN BECOME AN INTEGRAL PART OF THE LIGHTING DESIGN.

LEFT TO RIGHT:  
FROM THE COLLECTION OF DESIGNER PETER BRISTOL, THE EXPANDABLE, ACCORDION-LIKE INTERLACE CHANDELIER IS MADE OF A PLIANT STEEL LATTICE THAT CAN CHANGE SHAPE TO FIT YOUR SPACE. THE DOT STANCE ROTATING PENDANT IS BUILT UPON A MIRROR-THIN, DIFFUSED *LED*-LIT DISC THAT IS AVAILABLE IN TWO DIAMETERS. THE BEND LARGE TALL WALL LIGHT OFFERS A MINIMALIST TAKE ON A PLAQUE SCONCE, PRECISION-FORMED FROM A SEAMLESS SHEET OF BRASS.

## INNOVATIVE TECHNOLOGY





SELECTION + STYLE



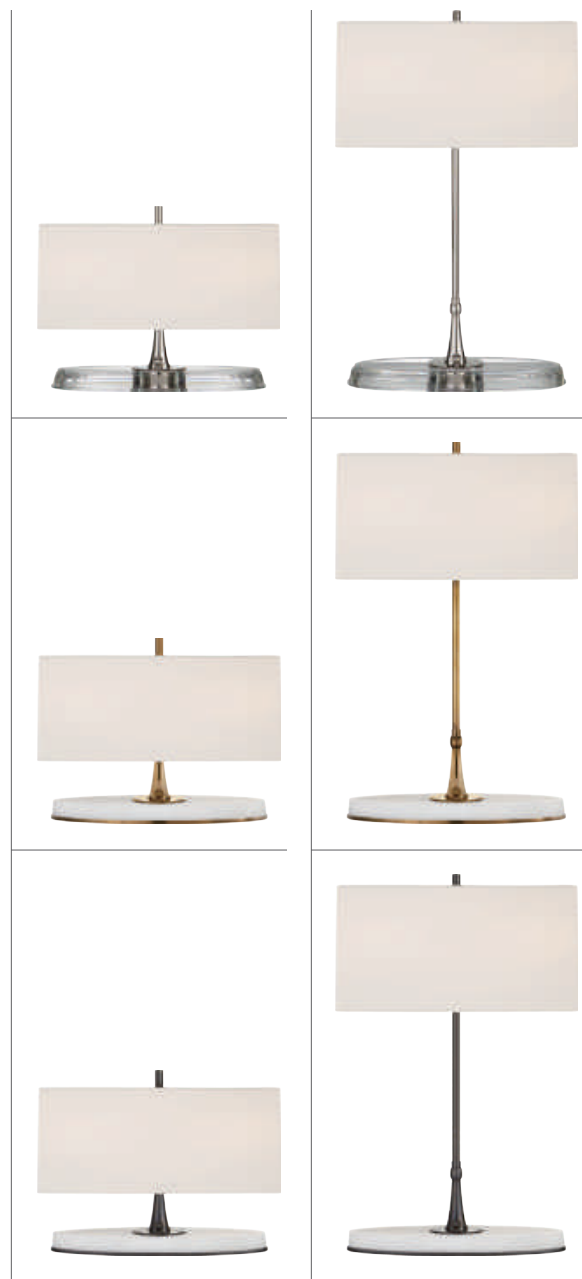

### WE FOCUS ON DELIVERING STYLE

Style matters to our customers, and it matters to us to deliver the best and broadest range of lighting styles to choose from. This means that we are continually developing every type of lighting, with diverse applications in our table, floor, ceiling, wall, and outdoor categories. And it means that within each category, we work with our designers to provide lighting in every aesthetic style, traditional to modern, formal to casual, elaborate to minimal.

Style and selection are also deeply linked to how we deliver value.

We promise that all of our collections will be of the same consistent high design caliber and quality, across varied environments and projects.

We offer a vast spectrum of products—in stock—for many levels of design and budget. And we simplify your work with the tools and expert customer service to make the ordering process easy and seamless.

THE CASPER TABLE LAMP BY THOMAS O'BRIEN CAN BE ADAPTED MANY WAYS. THE PROFILE IS AVAILABLE IN TWO SIZES, AS A MEDIUM TABLE LAMP AND A SMALL DESK LAMP, WITH TWO DIFFERENT BASES OF CRYSTAL OR STONE, AND THREE DIFFERENT METAL FINISHES.



# EXTRAORDINARY SELECTION

**ARTFUL PRODUCTS, EVERY APPLICATION.**

WITH MORE THAN 1,600 UNIQUE DESIGNS IN OVER 5,000 FINISH OPTIONS, WE OFFER THE LARGEST ASSORTMENT OF DECORATIVE LIGHTING FOR EVERY TASTE AND APPLICATION. AND WE MAKE SELECTION EXTREMELY SIMPLE THROUGH A CHOICE OF DIFFERENT FILTERS, SO THAT YOU CAN SEARCH FOR LIGHTING THE WAY YOU WANT.

FOR CURATED LIGHTS IN YOUR FAVORITE AESTHETIC, EXPLORE OUR GENERAL CATEGORIES BY LIGHTING TYPE, MATERIAL, STYLE, AND DESIGNER. OUR COLLECTION SPANS THE SPECTRUM FROM TRADITIONAL TO MODERN DESIGNS, WITH DECORATIVE AND FUNCTIONAL OPTIONS TO MEET YOUR PROJECT NEEDS. ALL OF OUR LIGHTS ARE LISTED WITH THEIR SIGNATURE AND SPECIALTY FINISHES, TO GIVE YOU A MORE PERSONALIZED SELECTION.

**TRADITIONAL**

**TABLE**



**FLOOR**



**CEILING**



**WALL**



**OUTDOOR**



**MODERN**



**CASUAL**

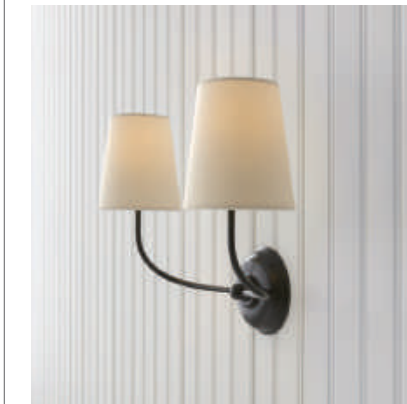



**DESIGN RICHNESS, INHERENT VALUE.**

WE DEFINE VALUE BY THE QUALITY THAT GOES INTO OUR PRODUCTS—THE TIMELESSNESS OF OUR DESIGN, THE CHARACTER OF OUR CRAFTSMANSHIP, AND THE BREADTH OF STYLES WE OFFER FOR EVERY TYPE OF PROJECT.

CLOCKWISE FROM LEFT:  
THE STATEMENT CEILING LIGHT, IMAGINED THREE DIFFERENT WAYS. LIMOGES PENDANTS BY SUZANNE KASLER REINTERPRET THE INDUSTRIAL WORK LIGHT IN A CASUAL STYLE, IDEAL FOR HANGING IN GROUPINGS. THE ROUSSEAU GRANDE TEN-LIGHT ARTICULATING CHANDELIER BY KELLY WEARSTLER DISTILLS THE FORM WITH MODERN SIMPLICITY; THE TRADITIONAL LINFORT BASKET FORM CHANDELIER BY E.F. CHAPMAN IS PERFECTLY CLASSIC IN ELEGANT CRYSTAL.



SIGNATURE STYLE





CREATIVITY + COLLABORATION





## WE CELEBRATE EXCEPTIONAL DESIGNERS

A great light must start with a great design. This philosophy is the bedrock of our company. It's why we've always focused on the incomparable product development that can only come from working with the most talented designers. And from their ideas, we are passionate about bringing to life the unique forms that they can envision.

Starting with design legend E.F. Chapman, we're proud to have a family of Design Icons at Visual Comfort who are the bright stars of their industry. Each of them conveys in their own style how great lighting is central to a complete design project. In addition, we are constantly cultivating new talent in order to add the next generation to our valued family of designers.

E.F. CHAPMAN HAS CREATED COUNTLESS LEGACY PRODUCTS FOR VISUAL COMFORT OVER THE YEARS. HIS KANG JUG LARGE TABLE LAMP BRINGS THE INFLUENCE OF TRADITIONAL EASTERN CERAMICS TO THE COLLECTION AND IS AVAILABLE IN FOUR RICH COLORWAYS. ALL OF OUR DESIGNERS SHARE THEIR OWN INTERESTS AND INDIVIDUAL STYLE IN LIGHTING DESIGNS FROM MANY POINTS OF VIEW.



# COLLECTIONS



E.F. CHAPMAN



THOMAS O'BRIEN



AERIN



KELLY WEARSTLER



SUZANNE KASLER



BARBARA BARRY



ALEXA HAMPTON



JULIE NEILL



J. RANDALL POWERS



IAN K. FOWLER

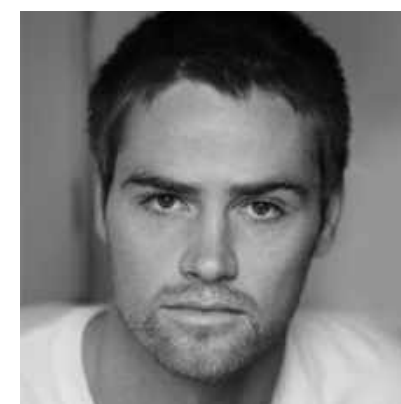

PETER BRISTOL



CHRISTOPHER SPITZMILLER



KATE SPADE NEW YORK



NIERMANN WEEKS

CONTRIBUTORS



LAUREN ROTTET



ERIC KOHLER



CLODAGH



JOHN ROSSELLI



MICHAEL S. SMITH

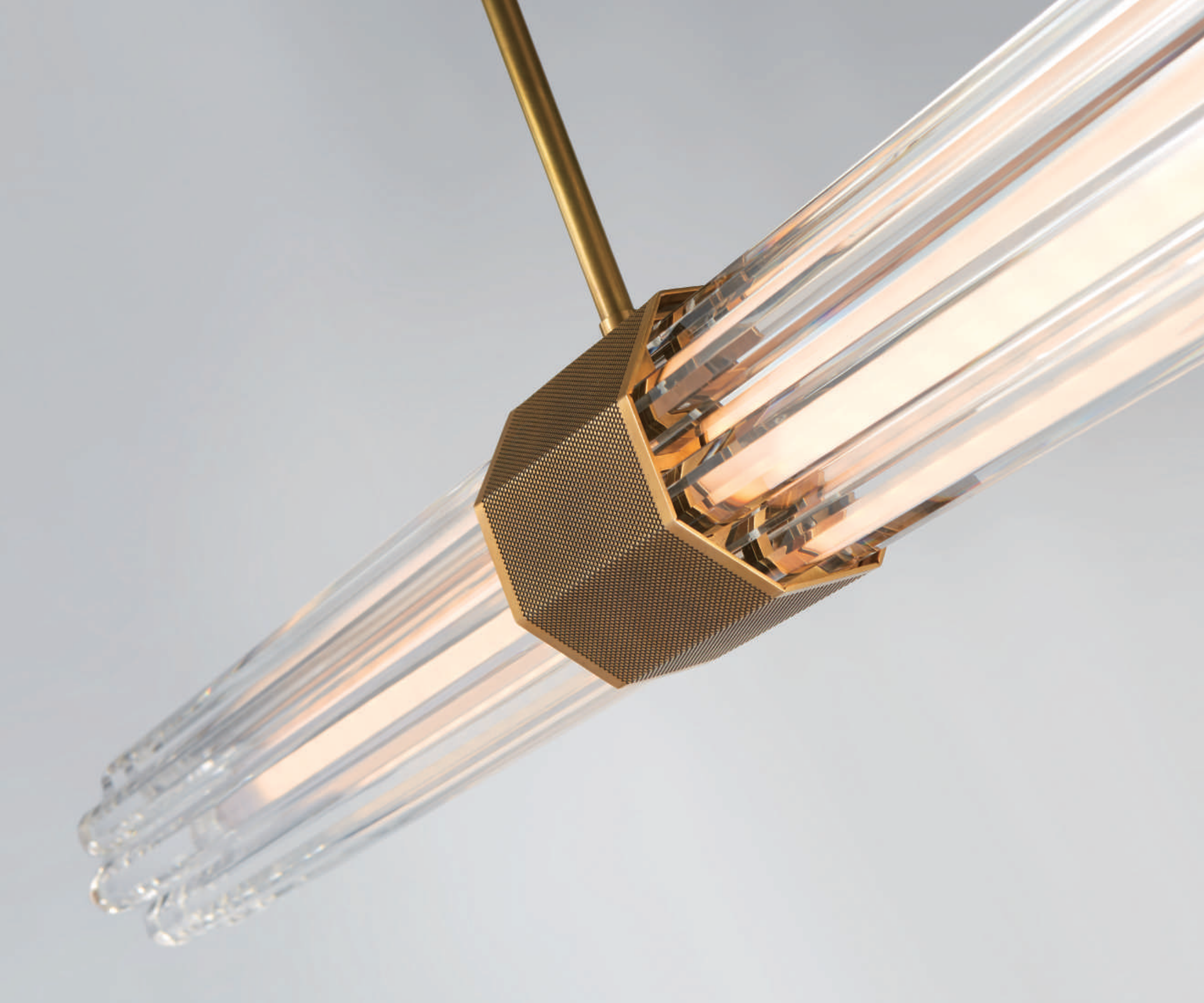



**TABLE 1**  
DECORATIVE 3 | FUNCTIONAL 123



**FLOOR 143**  
DECORATIVE 145 | FUNCTIONAL 201



**CEILING 235**  
CHANDELIER 237 | LINEAR 383 | HANGING SHADES 415 | PENDANTS 443 | LANTERNS 505 | FLUSH MOUNTS 567



**WALL 643**  
DECORATIVE 645 | FUNCTIONAL 799 | PICTURE 837 | BATH 851

# CONTENTS

**OUTDOOR 921**  
OUTDOOR FIXTURES 923





TABLE



TABLE | DECORATIVE

**A** **DARINA LARGE TABLE LAMP**  
AERIN

**ARN3609**  
H: 31" | W: 20" | Base: 5.75" Round  
Socket: E26 Dimmer | Bulb: 100 A  
Shade: 19" x 20" x 14.5"  
**Additional Options:**  
Pebbled Blue | Linen (PBL-L)

**B** **CULLODEN TABLE LAMP**  
AERIN

**ARN3608**  
H: 32.5" | W: 18" | Base: 6.5" Round  
Socket: E26 Dimmer | Bulb: 150 A  
Shade: 18" x 18" x 11"

**C** **GANNET TABLE LAMP**  
AERIN

**ARN3606**  
H: 29.25" | W: 17.5" | Base: 5" Round  
Socket: E26 Dimmer | Bulb: 150 A  
Shade: 16.5" x 17.5" x 12.5"  
**Additional Options:**  
Pebbled Aquamarine | Linen (PA-L)

\* Handmade Ceramics May Have Minor Variations

**A** **ARN3609VI-L**  
Volcanic Ivory | Linen



**B** **ARN3608PA-L**  
Pebbled Aquamarine | Linen

**B** **ARN3608VI-L**  
Volcanic Ivory | Linen



**B** **ARN3608BLL-L**  
Blue Lagoon | Linen



**B** **ARN3608BC-L**  
Bone Craquelure | Linen



**B** **ARN3608MS-L**  
Marbleized Sienna | Linen



**C** **ARN3606DC-L**  
Drizzled Cobalt | Linen



**C** **ARN3606BLL-L**  
Blue Lagoon | Linen



**C** **ARN3606BC-L**  
Bone Craquelure | Linen



**C** **ARN3606MS-L**  
Marbleized Sienna | Linen







**A** **ARN3622SHG-L**  
Shellish Gray | Linen

**A** **ARN3622BG-L**  
Chalk Burnt Gold | Linen



**A** **MICHELENA TABLE LAMP**  
AERIN

**ARN3622**  
H: 33.75" | W: 17" | Base: 5.25" Round  
Socket: 2 - E26 Keyless | Bulb: 2 - 60 A  
Shade: 15" x 17" x 16"  
**Additional Options:**  
Chalk White | Linen (CHW-L)  
\* Built-In Dimmer

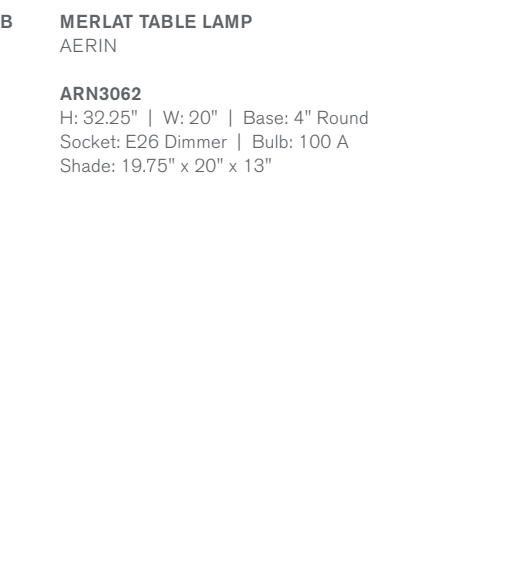

**B** **MERLAT TABLE LAMP**  
AERIN

**ARN3062**  
H: 32.25" | W: 20" | Base: 4" Round  
Socket: E26 Dimmer | Bulb: 100 A  
Shade: 19.75" x 20" x 13"



**C** **ARN3620SHG-L**  
Shellish Gray | Linen



**D** **ARN3623SHG-L**  
Shellish Gray | Linen

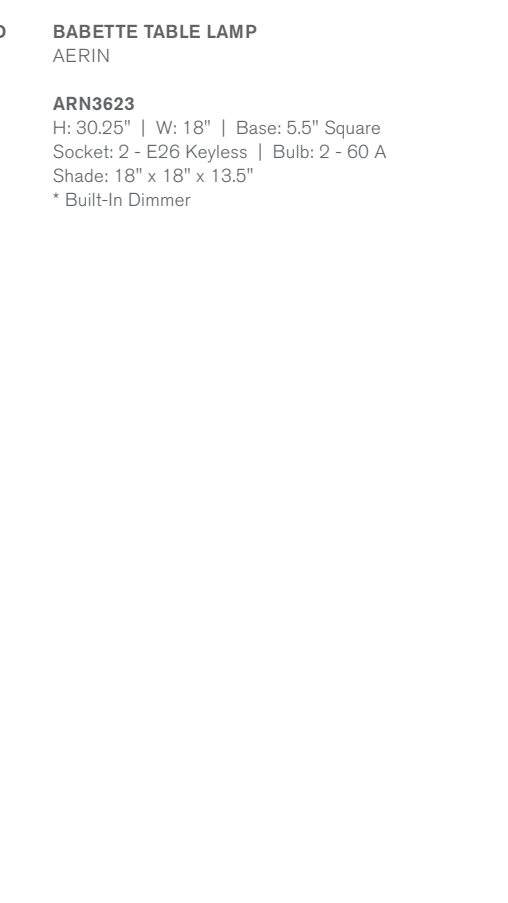

**D** **BABETTE TABLE LAMP**  
AERIN

**ARN3623**  
H: 30.25" | W: 18" | Base: 5.5" Square  
Socket: 2 - E26 Keyless | Bulb: 2 - 60 A  
Shade: 18" x 18" x 13.5"  
\* Built-In Dimmer



**E** **ARN3621MWT-L**  
Marion White | Linen



**E** **ARN3621BG-L**  
Chalk Burnt Gold | Linen

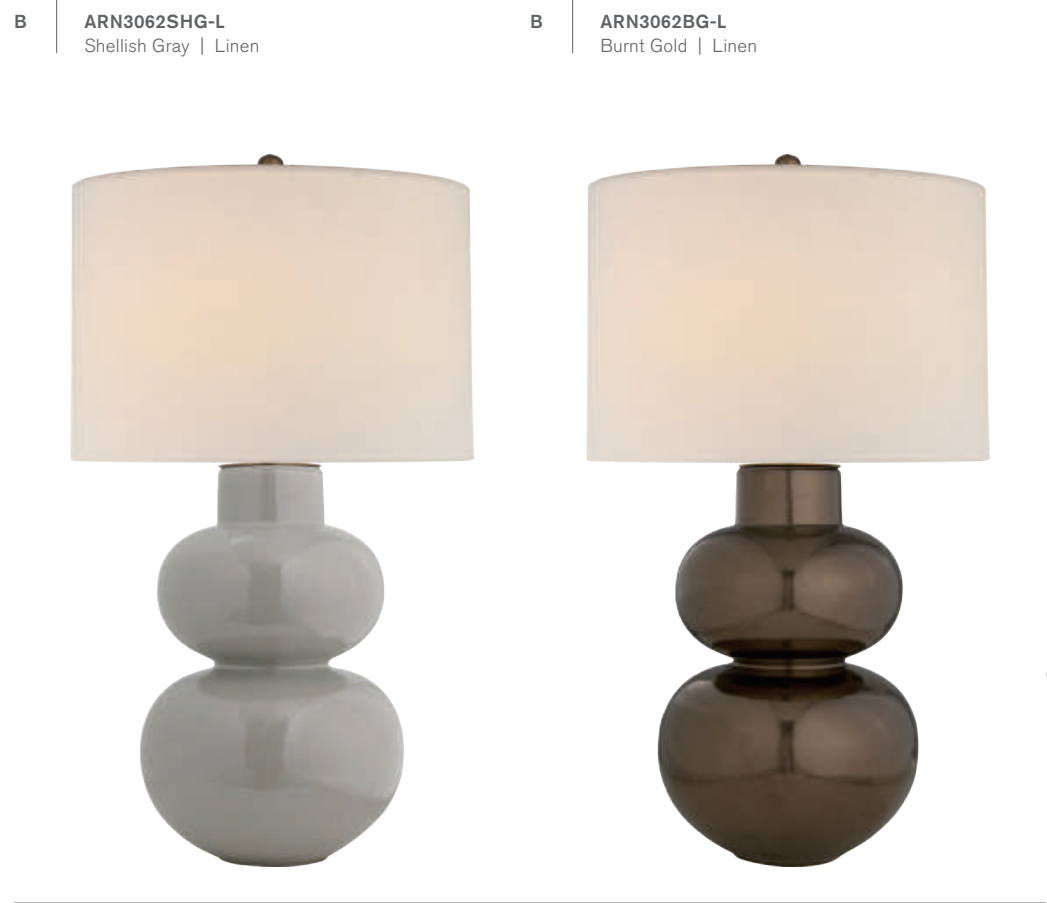

**B** **ARN3062SHG-L**  
Shellish Gray | Linen

**B** **ARN3062BG-L**  
Burnt Gold | Linen



**C** **ARN3620BG-L**  
Chalk Burnt Gold | Linen



**D** **ARN3623BG-L**  
Chalk Burnt Gold | Linen



**E** **FANETTE LARGE TABLE LAMP**  
AERIN

**ARN3621**  
H: 32.25" | W: 18" | Base: 11.5" x 18" Oval  
Socket: E26 Dimmer | Bulb: 100 A  
Shade: 17" x 18" x 19"



**F** **ARN3615VI-L**  
Volcanic Ivory | Linen



**F** **ARN3615BBK-L**  
Boiling Black | Linen

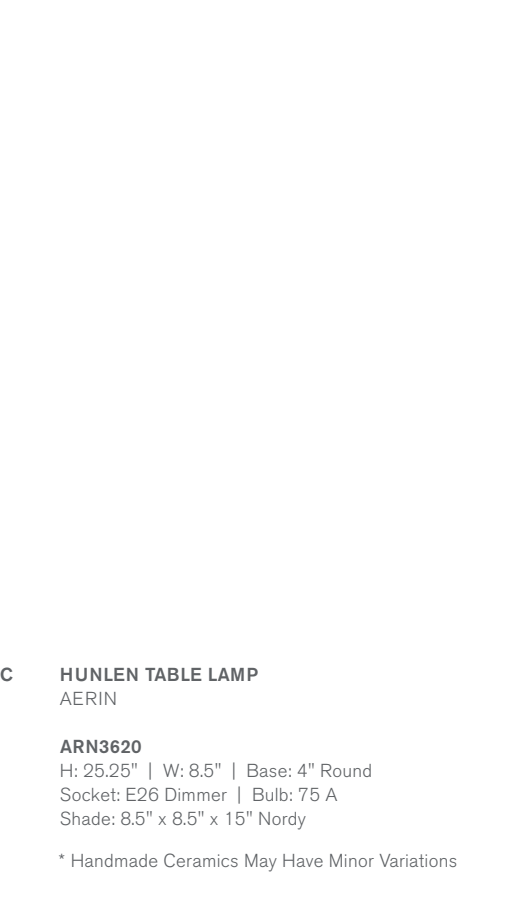

**C** **HUNLEN TABLE LAMP**  
AERIN

**ARN3620**  
H: 25.25" | W: 8.5" | Base: 4" Round  
Socket: E26 Dimmer | Bulb: 75 A  
Shade: 8.5" x 8.5" x 15" Nordy  
\* Handmade Ceramics May Have Minor Variations

**F** **NICOLAE LARGE TABLE LAMP**  
AERIN

**ARN3615**  
H: 34.25" | W: 20.5" | Base: 5.75" x 7" Diamond  
Socket: E26 Dimmer | Bulb: 100 A  
Shade: 18" x 20.5" x 14.5"

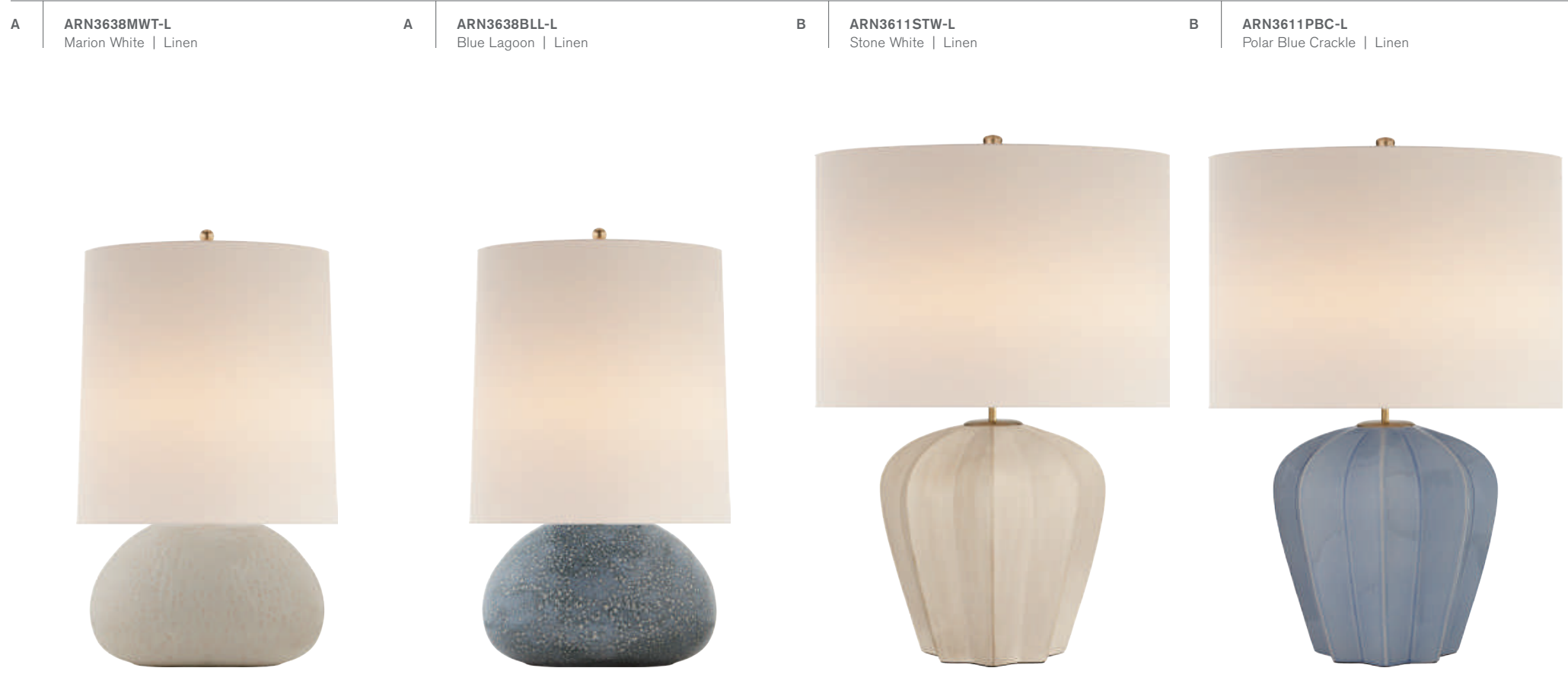

**A** | **SUMAVA MEDIUM TABLE LAMP**  
AERIN  
**ARN3638**  
H: 26.5" | W: 17" | Base: 5.75" x 9.5" Oval  
Socket: E26 Dimmer | Bulb: 100 A  
Shade: 16" x 17" x 17.5" Oval

**B** | **PIERREPONT TABLE LAMP**  
AERIN  
**ARN3611**  
H: 30" | W: 21" | Base: 13.5" Decorative  
Socket: E26 Dimmer | Bulb: 75 A  
Shade: 21" x 21" x 14"  
**Additional Options:**  
Bone Craquelure | Linen (BC-L)

**C** | **TOULON TABLE LAMP**  
AERIN  
**ARN3655**  
H: 27.25" | W: 17" | Base: 5.25" Round  
Socket: E26 Dimmer | Bulb: 75 A  
Shade: 13" x 17" x 13.5"

**D** | **GAIOS TABLE LAMP**  
AERIN  
**ARN3610**  
H: 30.5" | W: 21" | Base: 5.25" Round  
Socket: E26 Dimmer | Bulb: 150 A  
Shade: 21" x 21" x 13"

\* Handmade Ceramics May Have Minor Variations



A | **ARN3614PBC-L**  
Polar Blue Crackle | Linen



A | **ARN3614SHG-L**  
Shellish Gray | Linen



B | **BBL3601PBC-L**  
Polar Blue Crackle | Linen



A | **KAPILA TABLE LAMP**  
AERIN

**ARN3614**  
H: 28.75" | W: 17" | Base: 6.25" Round  
Socket: 2 - E26 Keyless | Bulb: 2 - 60 A  
Shade: 17" x 17" x 12.5"  
**Additional Options:**  
Blue Celadon | Linen (BC-L)  
\* Built-In Dimmer

B | **CHADO LARGE TABLE LAMP**  
BARBARA BARRY

**BBL3601**  
H: 31.25" | W: 15.75" | Base: 5.75" Round  
Socket: E26 Dimmer | Bulb: 100 A  
Shade: 15.25" x 15.75" x 13.5"  
**Additional Options:**  
Coconut | Linen (ICO-L)

C | **ATHENS LARGE TABLE LAMP**  
BARBARA BARRY

**BBL3901**  
H: 32.5" | W: 18" | Base: 5.75" Round  
Socket: E26 Dimmer | Bulb: 100 A  
Shade: 17" x 18" x 13"  
**Additional Options:**  
Dark Moss | Linen (DKM-L)

\* Handmade Ceramics May Have Minor Variations

B | **BBL3601PBC-L**  
Polar Blue Crackle | Linen



B | **BBL3601SHG-L**  
Shellish Gray | Linen



B | **BBL3601DKM-L**  
Dark Moss | Linen



C | **BBL3901PBC-L**  
Polar Blue Crackle | Linen



C | **BBL3901SHG-L**  
Shellish Gray | Linen



C | **BBL3901IVO-L**  
Ivory | Linen



**A** **KW3614AWC-L**  
Antiqued White | Linen



**A** **BETON LARGE TABLE LAMP**  
KELLY WEARSTLER

**KW3614**  
H: 35" | W: 21.5" | Base: 12.5" Round  
Socket: E26 Dimmer | Bulb: 75 A  
Shade: 18.25" x 21.5" x 15" Oval

**B** **KW3619AWC-L**  
Antiqued White | Linen



**B** **KW3619CBZ-L**  
Crystal Bronze | Linen



**B** **KW3619AWC-L**  
Antiqued White | Linen

**A** **KW3614CBZ-L**  
Crystal Bronze | Linen



**B** **PHOEBE STACKED TABLE LAMP**  
KELLY WEARSTLER

**KW3619**  
H: 28.5" | W: 17" | Base: 6.5" Round  
Socket: E26 Dimmer | Bulb: 75 A  
Shade: 13" x 17" x 13"

**C** **KW3024PWI-L**  
Porous White Ivory | Linen



**C** **KW3024SBK-L**  
Sand Wide Black Stripe | Linen



**C** **ALTA TABLE LAMP**  
KELLY WEARSTLER

**KW3024**  
H: 30" | W: 14" | Base: 5.25" Round  
Socket: E26 Dimmer | Bulb: 100 A  
Shade: 12" x 14" x 11" Round

\* Handmade Ceramics May Have Minor Variations





A | **KW3612SBM-AB**  
Black Metallic | Brass

A | **KW3612PRW-AB**  
Porous White | Brass



A | **KW3612SBM-L**  
Black Metallic | Linen



A | **ARMATO SMALL TABLE LAMP**  
KELLY WEARSTLER

**KW3612**  
H: 28" | W: 17.5" | Base: 6.25" Round  
Socket: E26 Dimmer | Bulb: 75 A  
Shade: 16.5" x 17.5" x 12" Oval  
**Additional Options:**  
Porous White | Linen (PRW-L)  
\* Line Switch

B | **MIRAMAR ACCENT LAMP**  
KELLY WEARSTLER

**KW3660**  
H: 21.25" | W: 16" | Base: 6.5" Round  
Socket: 3 - E12 Candelabra | Bulb: 3 - 25 B  
Shade: 3" x 16" x 4.75"

C | **MIRAMAR TABLE LAMP**  
KELLY WEARSTLER

**KW3661**  
H: 33" | W: 24" | Base: 9" Round  
Socket: 2 - E26 Keyless | Bulb: 2 - 40 A  
Shade: 3.5" x 24" x 7"

\* Handmade Ceramics May Have Minor Variations

B | **KW3660PRW-AB**  
Porous White | Antique-Burnished Brass



C | **KW3661PRW-AB**  
Porous White | Antique-Burnished Brass



B | **KW3660CBZ-AB**  
Crystal Bronze | Antique-Burnished Brass



C | **KW3661CBZ-AB**  
Crystal Bronze | Antique-Burnished Brass



**A** | **KW3640IVO-L**  
Ivory | Linen



**A** | **KW3640BLK-L**  
Black | Linen



**A** | **PASTICHE LARGE TABLE LAMP**  
KELLY WEARSTLER

**KW3640**  
H: 33.25" | W: 15.5" | Base: 6" Round  
Socket: 2 - E26 Keyless | Bulb: 2 - 75 A  
Shade: 15.5" x 15.5" x 16.25"

**B** | **NERO LARGE TABLE LAMP**  
KELLY WEARSTLER

**KW3680**  
H: 31.25" | W: 17" | Base: 8" Round  
Socket: E26 Keyless | Bulb: 12 LED A  
Shade: 15.5" x 17" x 13.5"

**C** | **BAYLISS TABLE LAMP**  
KELLY WEARSTLER

**KW3046**  
H: 31.75" | W: 17" | Base: 8" Square  
Socket: E26 Dimmer | Bulb: 150 A  
Shade: 11" x 17" x 12.5"

**B** | **KW3680WWT-L**  
Matte White | Linen



**B** | **KW3680MBK-L**  
Matte Black | Linen



**C** | **KW3046WLC-L**  
Satin White | Linen



**C** | **KW3046BLK-L**  
Black | Linen



opposite page

**D** | **LINDEN TABLE LAMP**  
KELLY WEARSTLER

**KW3032**  
H: 34.25" | W: 23" | Base: 9" Round  
Socket: E26 Dimmer | Bulb: 100 A  
Shade: 12" x 23" x 14.5"  
**Additional Options:**  
Black | Linen (BLK-L)

**E** | **LINDEN MEDIUM LAMP**  
KELLY WEARSTLER

**KW3031**  
H: 26.5" | W: 17" | Base: 6.5" Round  
Socket: E26 Dimmer | Bulb: 75 A  
Shade: 13" x 17" x 12"

\* Handmade Ceramics May Have Minor Variations

**D** | **KW3032PW-L**  
Matte White | Linen



**E** | **KW3031PW-L**  
Plaster White | Linen



**E** | **KW3031BLK-L**  
Black | Linen



**A** **CHA8693WHT-PL**  
Matte White | Percalé



**A** **CHA8693CBZ-PL**  
Crystal Bronze | Percalé



**A** **CHA8693SHG-PL**  
Shellish Gray | Percalé



opposite page

**A** **STACKED DISK TABLE LAMP**  
E. F. CHAPMAN

**CHA8693**  
H: 29" | W: 19.5" | Base: 10.75" Round  
Socket: E26 Dimmer | Bulb: 100 A  
Shade: 19.5" x 19.5" x 11.5"  
©EFC DESIGNS

**B** **CHA8668ICO-PL**  
Iced Coconut | Percalé



**B** **CHA8668SHK-PL**  
Shellish Kiwi | Percalé



**B** **CHA8668OSB-PL**  
Oslo Blue | Percalé



**C** **CHA8670ICO-PL**  
Iced Coconut | Percalé



**C** **CHA8670SHK-PL**  
Shellish Kiwi | Percalé



**C** **CHA8670OSB-PL**  
Oslo Blue | Percalé



**B** **PARISIENNE SMALL TABLE LAMP**  
E. F. CHAPMAN

**CHA8668**  
H: 28.75" | W: 17" | Base: 8.75" Square  
Socket: E26 Dimmer | Bulb: 150 A  
Shade: 15" x 17" x 10"  
**Additional Options:**  
Denim | Percalé (DM-PL)  
©EFC DESIGNS

**C** **PARISIENNE MEDIUM TABLE LAMP**  
E. F. CHAPMAN

**CHA8670**  
H: 35" | W: 20" | Base: 8" Square  
Socket: E26 Dimmer | Bulb: 150 A  
Shade: 17" x 20" x 13"  
**Additional Options:**  
Denim | Percalé (DM-PL)  
©EFC DESIGNS

\* Handmade Ceramics May Have Minor Variations

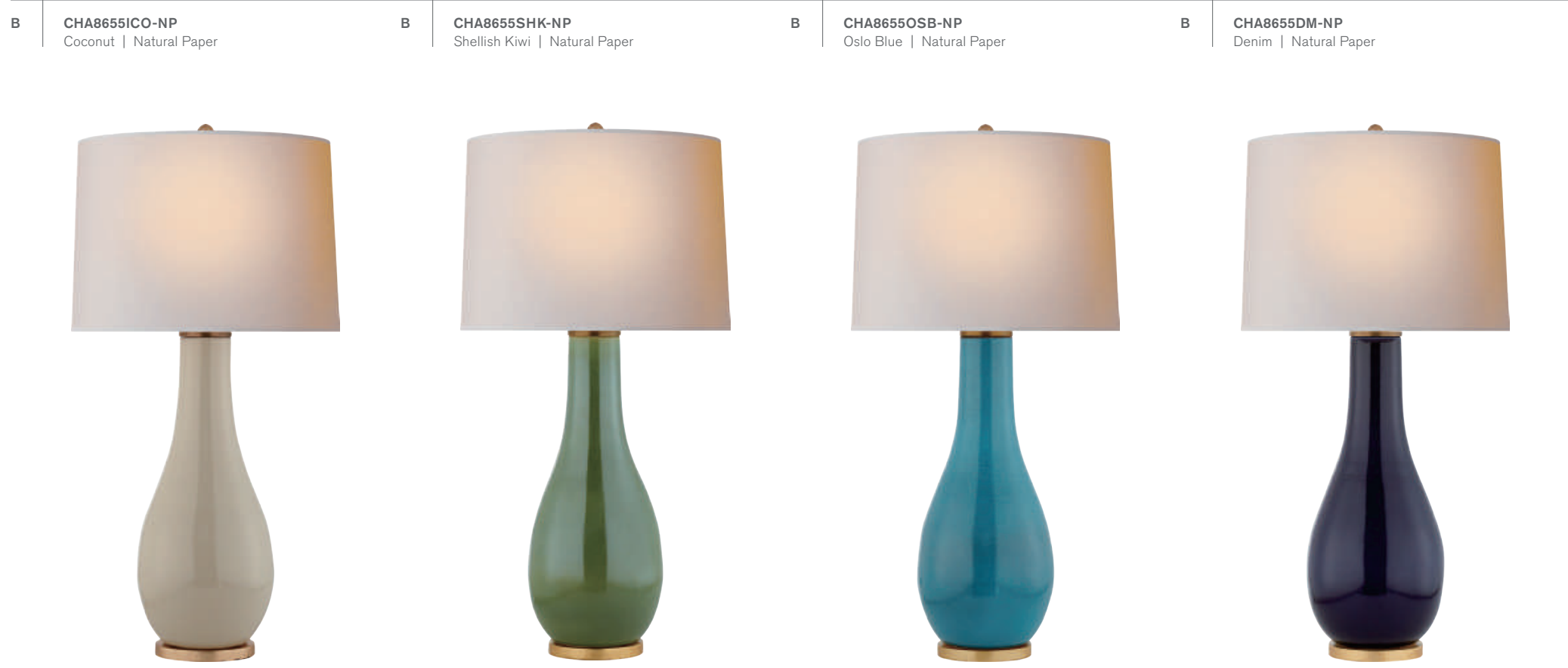
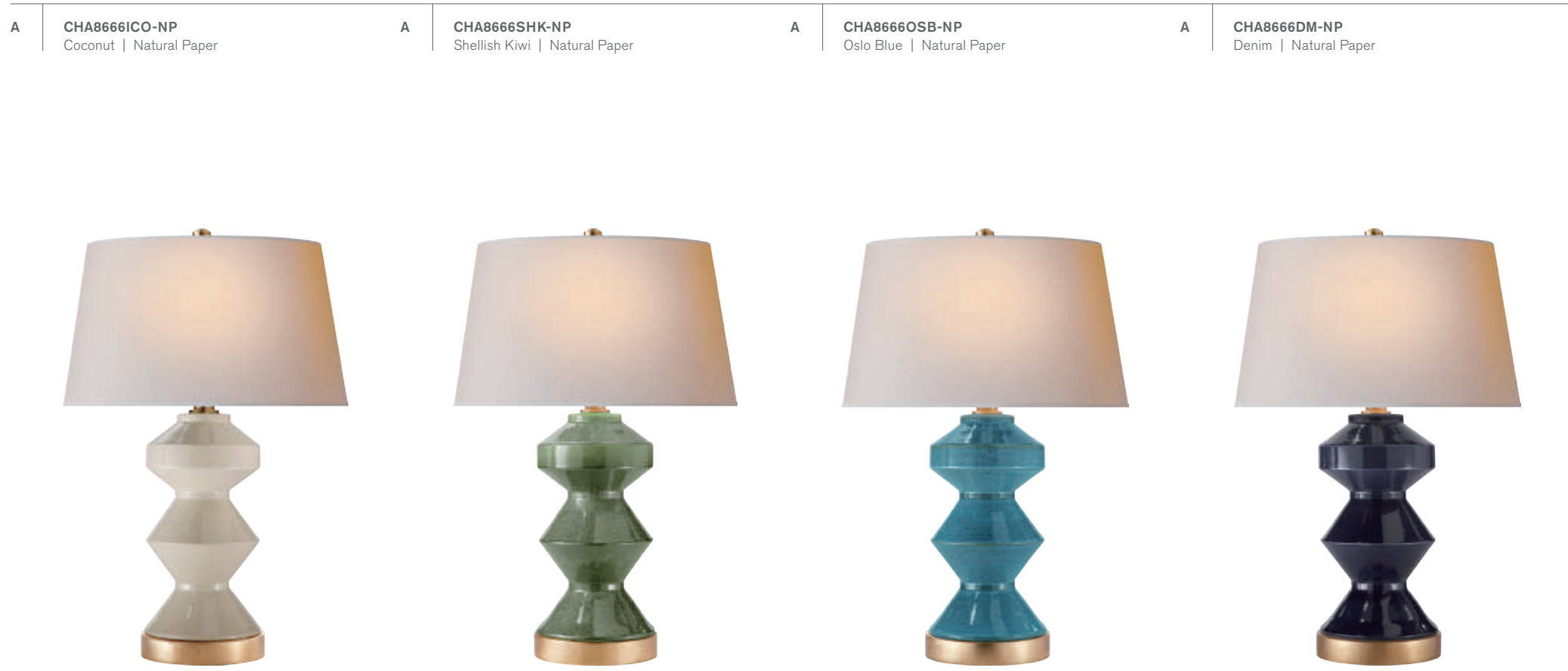

**A** | **CHA8666DM-NP**  
Denim | Natural Paper



**A** | **WELLER ZIG-ZAG TABLE LAMP**  
E. F. CHAPMAN

**CHA8666**  
H: 26.5" | W: 19" | Base: 8" Round  
Socket: E26 Dimmer | Bulb: 150 A  
Shade: 15.5" x 19" x 10.5"  
©EFC DESIGNS

**B** | **ORSON BALUSTRADE FORM TABLE**  
E. F. CHAPMAN

**CHA8655**  
H: 32.5" | W: 17" | Base: 6" Round  
Socket: E26 Dimmer | Bulb: 150 A  
Shade: 16" x 17" x 12"  
©EFC DESIGNS

**C** | **DIANTHUS LARGE TABLE LAMP**  
E. F. CHAPMAN

**CHA8697**  
H: 31" | W: 20" | Base: 6.5" Round  
Socket: E26 Dimmer | Bulb: 150 A  
Shade: 19" x 20" x 12.5"  
**Additional Options:**  
Flowing Blue | Natural Percale (FLB-PL)  
Ivory | Natural Percale (IVO-PL)  
©EFC DESIGNS

\* Handmade Ceramics May Have Minor Variations

**C** | **CHA8697DSR-PL**  
Desert Rain | Natural Percale





A CHA8694IVO/BG-PL  
Ivory | Burnt Gold | Natural Percale



A KANG JUG LARGE TABLE LAMP  
E. F. CHAPMAN

CHA8694  
H: 29" | W: 17" | Base: 5.75" Square  
Socket: E26 Dimmer | Bulb: 100 A  
Shade: 15" x 17" x 12" Square  
©EFC DESIGNS

A CHA8694IVO/BG-PL  
Ivory | Burnt Gold | Natural Percale



A CHA8694ACO/BG-PL  
Autumn Copper | Burnt Gold | Natural Percale



A CHA8694OSG/BG-PL  
Oslo Green | Burnt Gold | Natural Percale



A CHA8694MBB/BG-PL  
Mixed Blue Brown | Burnt Gold | Natural Percale



B FINLEY LARGE BALUSTRADE TABLE LAMP  
E. F. CHAPMAN

CHA8654  
H: 32" | W: 17" | Base: 6.75" Square  
Socket: E26 Dimmer | Bulb: 100 A  
Shade: 15.5" x 17" x 13" Square  
©EFC DESIGNS

B CHA8654IVO-L  
Ivory | Linen



B CHA8654SHG-L  
Shellish Gray | Linen



B CHA8654OSG-L  
Oslo Green | Linen



B CHA8654MBB-L  
Mixed Blue Brown | Linen



\* Handmade Ceramics May Have Minor Variations

**A** **CHA8627IC-NP**  
Crackle | Natural Paper



**B** **CHA8642TS-NP**  
Tea Stain | Natural Paper



**C** **CHA8608TS-NP**  
Tea Stain | Natural Paper



**C** **CHA8608TS-NP**  
Tea Stain | Natural Paper



**C** **CHA8608CC-NP**  
Celadon Crackle | Natural Paper



opposite page

**A** **FANG GOURD TABLE LAMP**  
E. F. CHAPMAN

**CHA8627**  
H: 27" | W: 18" | Base: 6.25" Square  
Socket: E26 Dimmer | Bulb: 150 A  
Shade: 14" x 18" x 11" Rec.  
©EFC DESIGNS

**B** **ARC POT FORM TABLE LAMP**  
E. F. CHAPMAN

H: 29.25" | W: 19" | Base: 6.5" Round  
Socket: E26 Dimmer | Bulb: 150 A  
Shade: 15" x 19" x 12"  
©EFC DESIGNS

**C** **DEAUVILLE TABLE LAMP**  
E. F. CHAPMAN

**CHA8608**  
H: 30.25" | W: 18" | Base: 7" Round  
Socket: E26 Dimmer | Bulb: 150 A  
Shade: 16" x 18" x 12"  
©EFC DESIGNS

**D** **GOURD FORM SMALL TABLE LAMP**  
E. F. CHAPMAN

**CHA8613**  
H: 26" | W: 16" | Base: 6" Square  
Socket: E26 Dimmer | Bulb: 100 A  
Shade: 12" x 16" x 11"  
©EFC DESIGNS

**E** **GOURD FORM LARGE TABLE LAMP**  
E. F. CHAPMAN

**CHA8615**  
H: 34.5" | W: 20" | Base: 7.5" Square  
Socket: E26 Dimmer | Bulb: 150 A  
Shade: 15" x 20" x 14"  
©EFC DESIGNS

\* Handmade Ceramics May Have Minor Variations

**D** **CHA8613TS-NP**  
Tea Stain | Natural Paper



**E** **CHA8615TS-NP**  
Tea Stain | Natural Paper



**D** **CHA8613CC-NP**  
Celadon Crackle | Natural Paper



**E** **CHA8615CC-NP**  
Celadon Crackle | Natural Paper



**A** JN3605IVO-L  
Ivory | Linen



**A** JN3605PLB-L  
Pale Blue | Linen



**A** JN3605MBB-L  
Mixed Blue Brown | Linen



**A** ANTOINE LARGE TABLE LAMP  
JULIE NEILL

**JN3605**  
H: 30" | W: 16" | Base: 6" Square  
Socket: E26 Dimmer | Bulb: 100 A  
Shade: 16" x 16" x 10"

**B** YUE DOUBLE GOURD TABLE LAMP  
E. F. CHAPMAN

**CHA8663**  
H: 31.25" | W: 22" | Base: 7" Round  
Socket: E26 Dimmer | Bulb: 100 A  
Shade: 9" x 22" x 13"  
©EFC DESIGNS

**C** CHA8661ICO-NP  
Coconut | Natural Paper



**B** CHA8663ICO-NP  
Coconut | Natural Paper



**B** CHA8663ICB-NP  
Ice Blue | Natural Paper



**B** CHA8663DM-NP  
Denim | Natural Paper



**C** CHA8661ICB-NP  
Ice Blue | Natural Paper



opposite page

**C** LAMBAY TABLE LAMP  
E. F. CHAPMAN

**CHA8661**  
H: 32" | W: 22" | Base: 7" Round  
Socket: E26 Dimmer | Bulb: 100 A  
Shade: 9" x 22" x 13"  
©EFC DESIGNS

\* Handmade Ceramics May Have Minor Variations

**C** CHA8661DM-NP  
Denim | Natural Paper



**A** **AH3082TS-NP**  
Tea Stain | Natural Paper

**A** **AH3082MB-NP**  
Midnight Blue | Natural Paper



**A** **SAWYER TABLE LAMP**  
ALEXA HAMPTON

**AH3082**  
H: 25" | W: 13.75" | Base: 7" Round  
Socket: E26 Dimmer | Bulb: 100 A  
Shade: 7.75" x 13.75" x 9.25"

**B** **ANITA TABLE LAMP**  
ALEXA HAMPTON

**AH3063**  
H: 28.5" | W: 18" | Base: 4.75" x 7" Rec.  
Socket: E26 Dimmer | Bulb: 150 A  
Shade: 14" x 18" x 11" Rec.

**C** **AH3127WHT-PL**  
Gloss White | Percalé



**B** **AH3063TS-NP**  
Tea Stain | Natural Paper

**B** **AH3063MB-NP**  
Midnight Blue | Natural Paper



**C** **PENELOPE TABLE LAMP**  
ALEXA HAMPTON

**AH3127**  
H: 30" | W: 17" | Base: 6" Round  
Socket: 2 - E26 Pull Chain | Bulb: 2 - 60 A  
Shade: 9" x 17" x 12.75"

**C** **AH3127DM-PL**  
Denim | Percalé



\* Handmade Ceramics May Have Minor Variations

**C** **AH3127GRN-PL**  
Green | Percalé



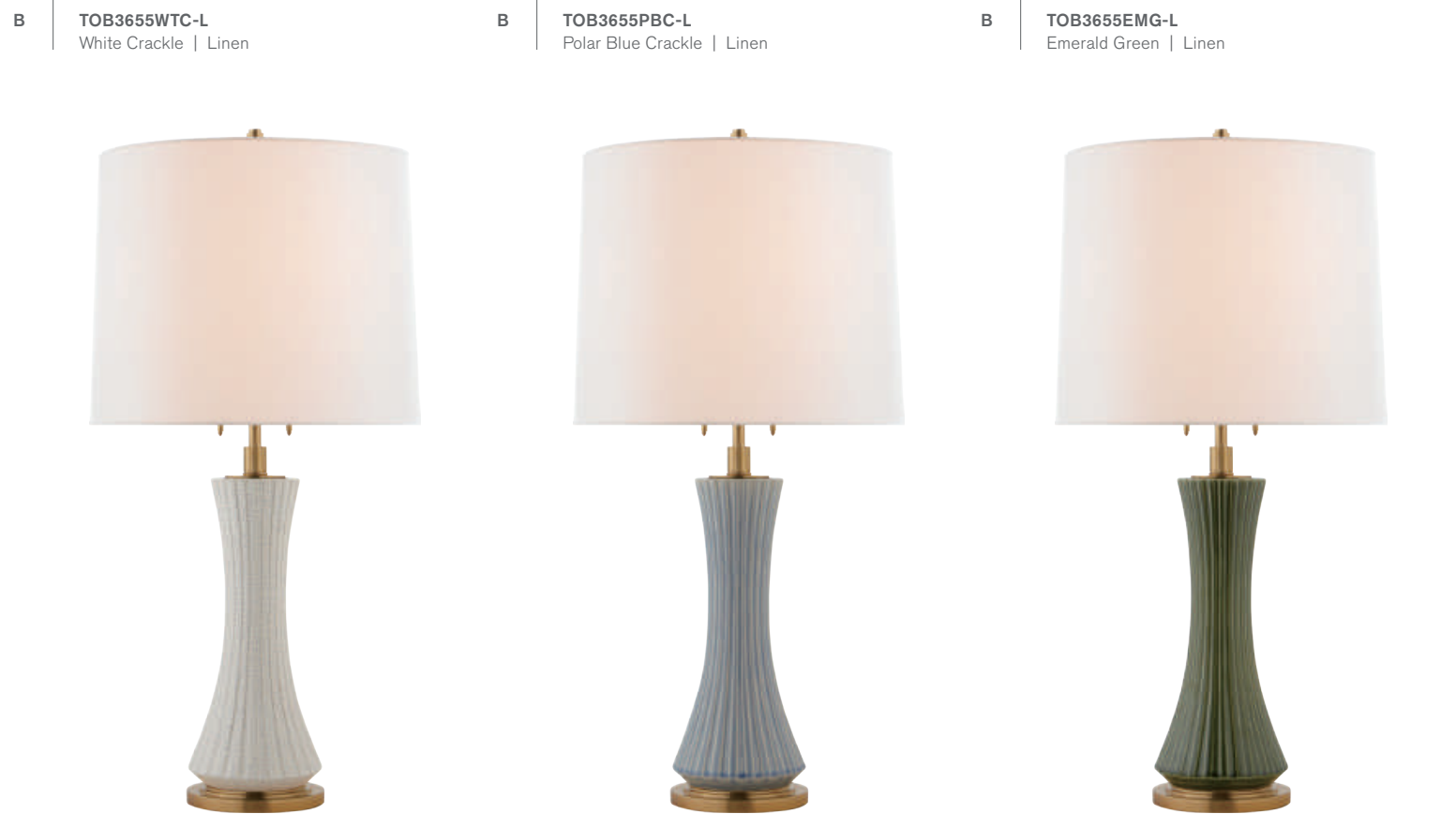
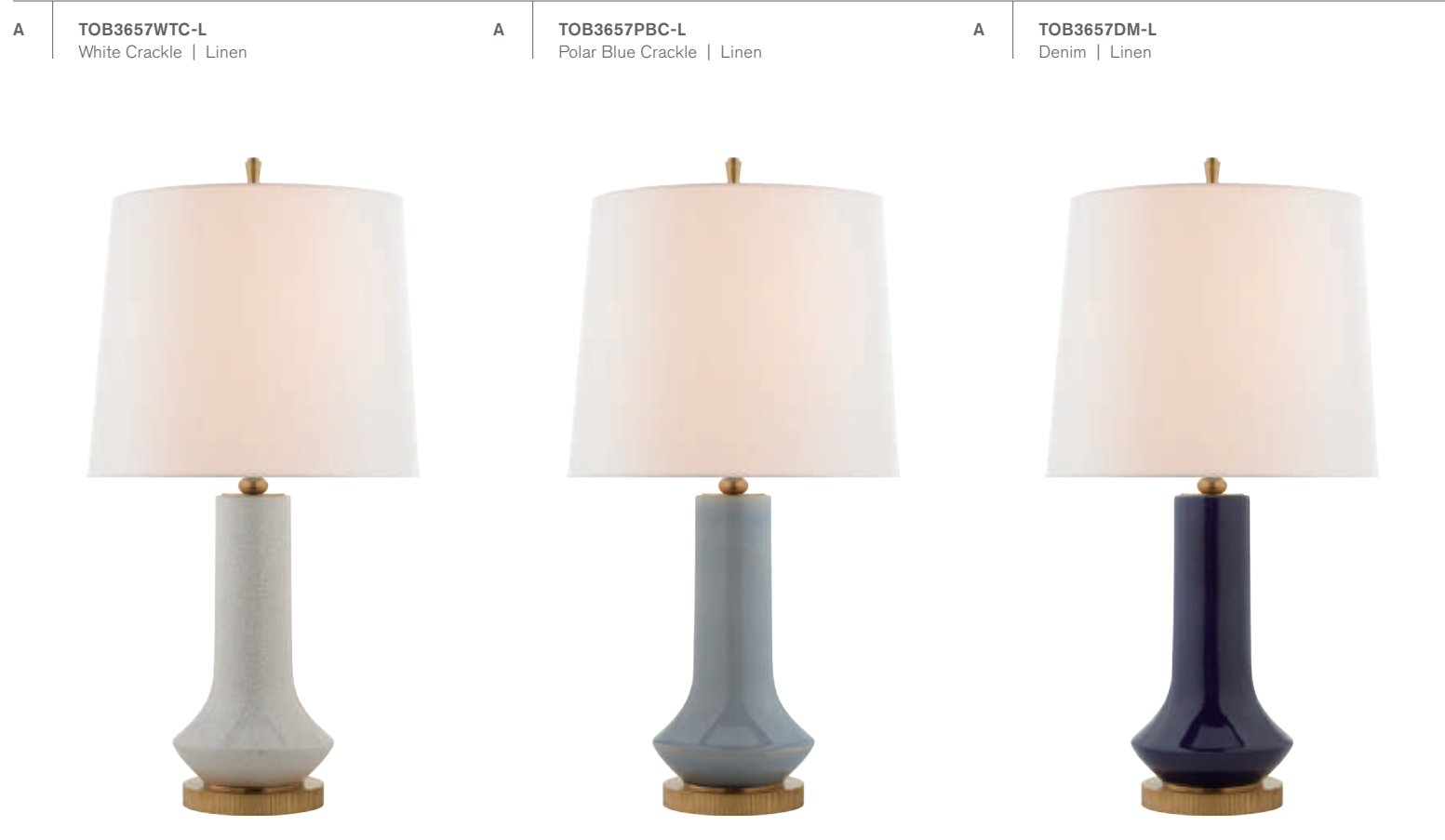

**A** **LUISA LARGE TABLE LAMP**  
THOMAS O'BRIEN  
**TOB3657**  
H: 31.25" | W: 16" | Base: 6.75" Round  
Socket: 2 - E26 Pull Chain | Bulb: 2 - 60 A  
Shade: 14" x 16" x 13"  
**Additional Options:**  
Emerald Green | Linen (EMG-L)

**B** **ELENA LARGE TABLE LAMP**  
THOMAS O'BRIEN  
**TOB3655**  
H: 32" | W: 16" | Base: 6.75" Round  
Socket: 2 - E26 Pull Chain | Bulb: 2 - 60 A  
Shade: 14" x 16" x 13"  
**Additional Options:**  
Denim | Linen (DM-L)

opposite page  
**C** **TAMASO SMALL TABLE LAMP**  
THOMAS O'BRIEN  
**TOB3710**  
H: 31" - 34.75" | W: 14.5" | Base: 7.5" Square  
Socket: 2 - E26 Pull Chain | Bulb: 2 - 60 A  
Shade: 13" x 14.5" x 14.5"  
**Additional Options:**  
Black Crackle | Natural Paper (BLK-NP)

**D** **MIMI TABLE LAMP**  
THOMAS O'BRIEN  
**TOB3804**  
H: 27.5" | W: 16.5" | Base: 7" x 10" Rec.  
Socket: 2 - E26 Pull Chain | Bulb: 2 - 60 A  
Shade: 12" x 16.5" x 12.75" Round  
**Additional Options:**  
Black | Natural Paper (BLK-NP)  
Light Honey | Natural Paper (LH-NP)  
\* Handmade Ceramics May Have Minor Variations

**C** **TOB3710TS-NP**  
Tea Stain | Natural Paper

**D** **TOB3804TS-NP**  
Tea Stain | Natural Paper

**D** **TOB3804OSB-NP**  
Oslo Blue | Natural Paper



**A NEWCOMB MEDIUM TABLE LAMP**  
CHRISTOPHER SPITZMILLER

**CS3622**  
H: 30" | W: 18.25" | Base: 5.5" Round  
Socket: E26 Dimmer | Bulb: 100 A  
Shade: 16" x 18.25" x 12"  
**Additional Options:**  
Matte Bronze | Percale (MBZ-PL)

**B NOTA MEDIUM TABLE LAMP**  
CHRISTOPHER SPITZMILLER

**CS3626**  
H: 29.25" | W: 16" | Base: 5.5" Round  
Socket: E26 Dimmer | Bulb: 100 A  
Shade: 8" x 16" x 12"  
**Additional Options:**  
Aqua Crackle | Percale (AQC-PL)  
Cinnabar | Percale (CIN-PL)  
Lime | Percale (LME-PL)  
Mixed Blue Brown | Percale (MBB-PL)  
Matte Sky Blue | Percale (MSB-PL)

**C NOTA LARGE TABLE LAMP**  
CHRISTOPHER SPITZMILLER

**CS3627**  
H: 34.5" | W: 20" | Base: 6.75" Round  
Socket: E26 Dimmer | Bulb: 100 A  
Shade: 10" x 20" x 14"  
**Additional Options:**  
Aqua Crackle | Percale (AQC-PL)  
Cinnabar | Percale (CIN-PL)  
Dark Honey | Percale (DKH-PL)  
Ivory | Percale (IVO-PL)



**A CS3622MBB-PL**  
Mixed Blue Brown | Percale

**A CS3622IVO-PL**  
Ivory | Percale

**A CS3622DKH-PL**  
Dark Honey | Percale

**A CS3622AQC-PL**  
Aqua Crackle | Percale

**A CS3622MBB-PL**  
Mixed Blue Brown | Percale



**B CS3626IVO-PL**  
Ivory | Percale

**B CS3626DKH-PL**  
Dark Honey | Percale

**C CS3627MSB-PL**  
Matte Sky Blue | Percale

**C CS3627MBB-PL**  
Mixed Blue Brown | Percale



\* Handmade Ceramics May Have Minor Variations

A CS3611MSB-PL  
Matte Sky Blue | Percalé



A COY MEDIUM TABLE LAMP  
CHRISTOPHER SPITZMILLER

**CS3611**  
H: 31.5" | W: 18.25" | Base: 6" Round  
Socket: E26 Dimmer | Bulb: 100 A  
Shade: 16" x 18.25" x 12"  
**Additional Options:**  
Cinnabar | Percalé (CIN-PL)

A CS3611IVO-PL  
Ivory | Percalé



A CS3611AQC-PL  
Aqua Crackle | Percalé



A CS3611LME-PL  
Lime | Percalé



A CS3611MBZ-PL  
Matte Bronze | Percalé



B COY LARGE TABLE LAMP  
CHRISTOPHER SPITZMILLER

**CS3612**  
H: 35.75" | W: 21" | Base: 7.5" Round  
Socket: E26 Dimmer | Bulb: 100 A  
Shade: 18.25" x 21" x 13.75"  
**Additional Options:**  
Cinnabar | Percalé (CIN-PL)

B CS3612IVO-PL  
Ivory | Percalé



B CS3612AQC-PL  
Aqua Crackle | Percalé



B CS3612LME-PL  
Lime | Percalé



B CS3612MBZ-PL  
Matte Bronze | Percalé



\* Handmade Ceramics May Have Minor Variations

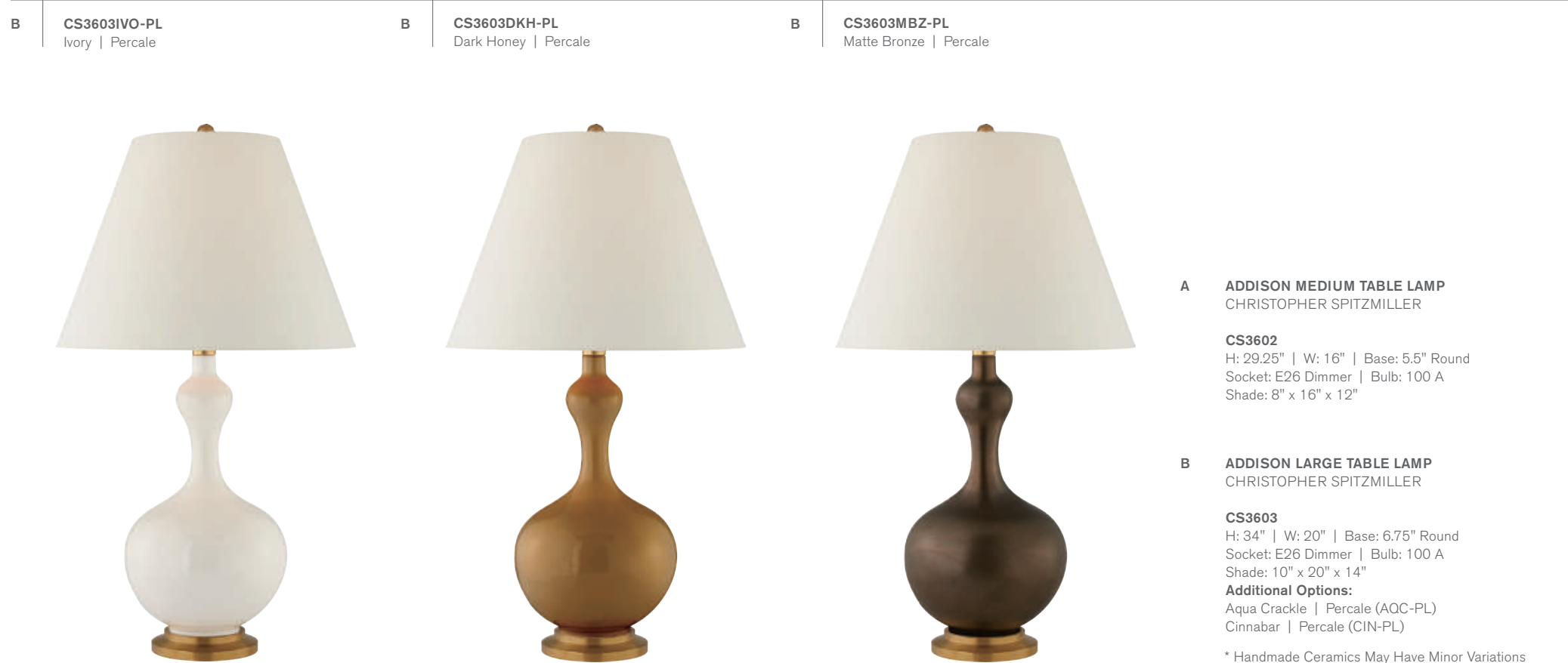
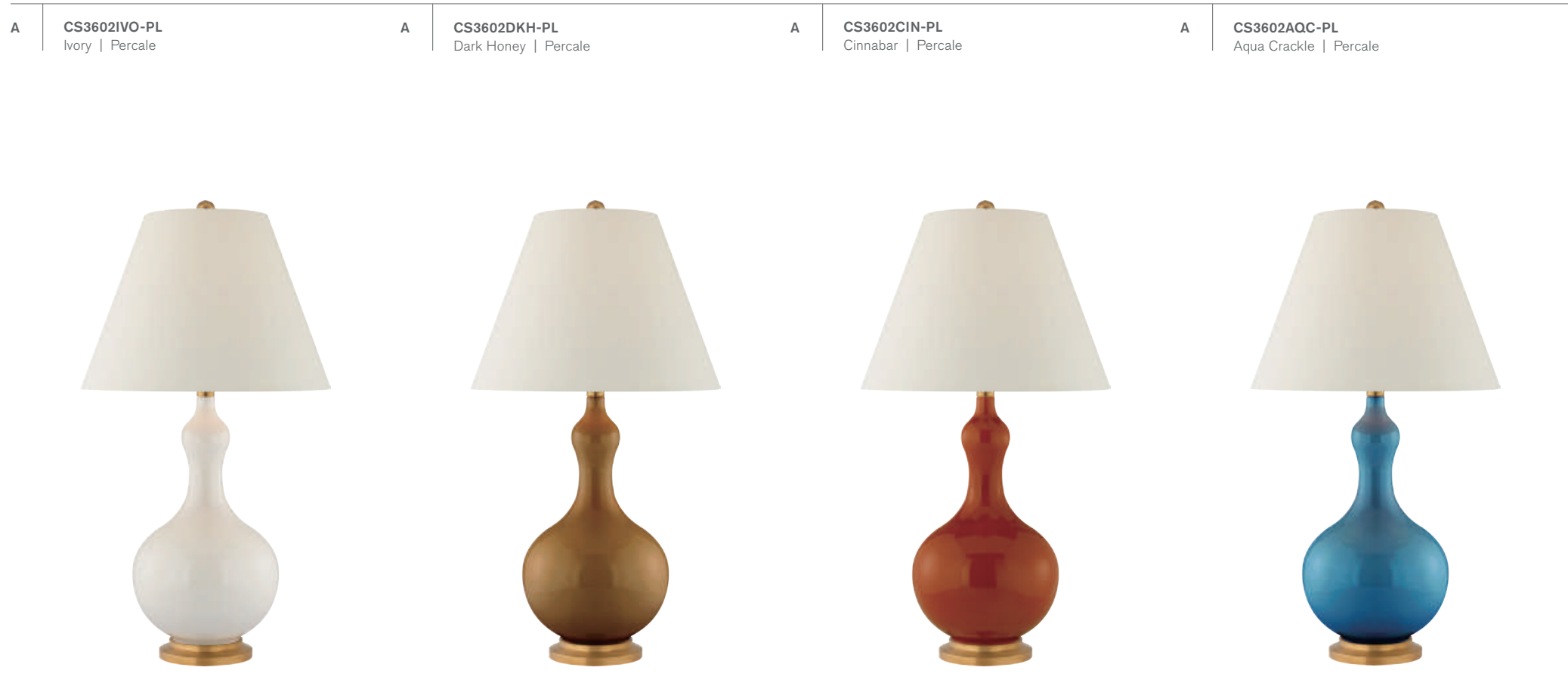

**A ADDISON MEDIUM TABLE LAMP**  
CHRISTOPHER SPITZMILLER

**CS3602**  
H: 29.25" | W: 16" | Base: 5.5" Round  
Socket: E26 Dimmer | Bulb: 100 A  
Shade: 8" x 16" x 12"

**B ADDISON LARGE TABLE LAMP**  
CHRISTOPHER SPITZMILLER

**CS3603**  
H: 34" | W: 20" | Base: 6.75" Round  
Socket: E26 Dimmer | Bulb: 100 A  
Shade: 10" x 20" x 14"  
**Additional Options:**  
Aqua Crackle | Percalé (AQC-PL)  
Cinnabar | Percalé (CIN-PL)

\* Handmade Ceramics May Have Minor Variations

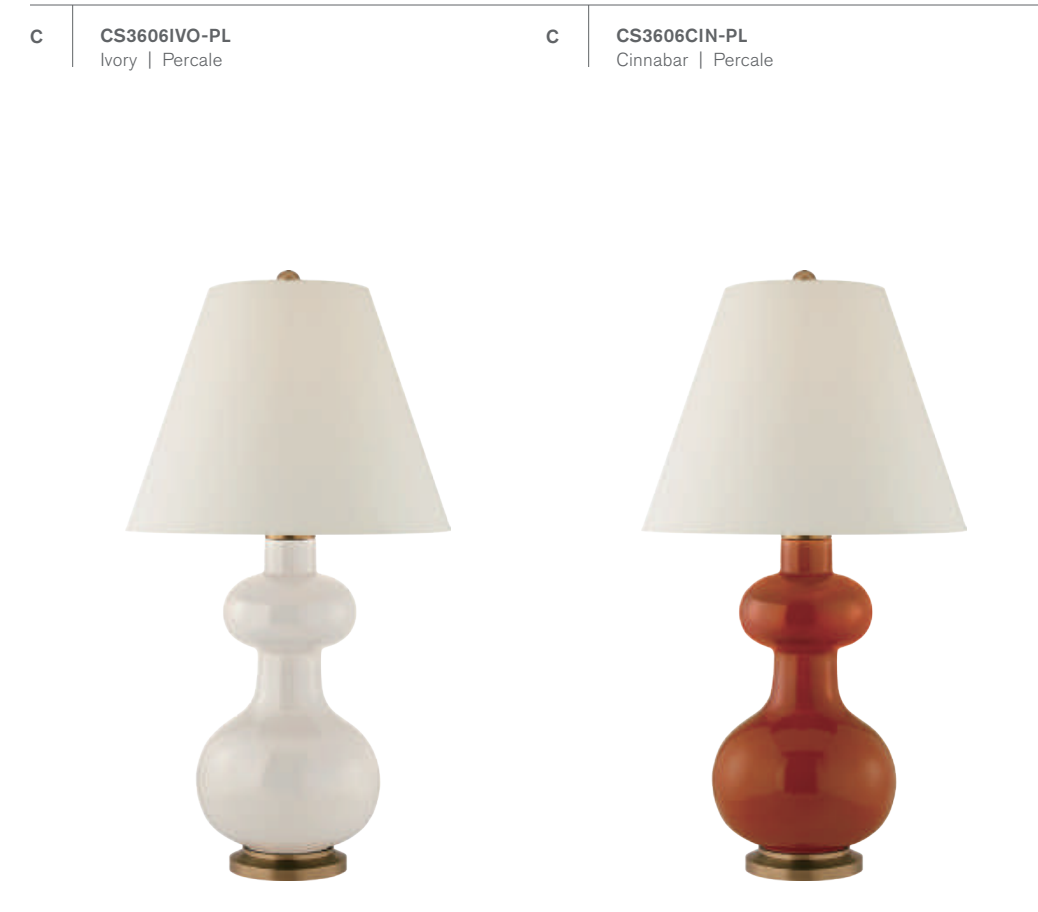

**C CHAMBERS MEDIUM TABLE LAMP**  
CHRISTOPHER SPITZMILLER

**CS3606**  
H: 29.25" | W: 16" | Base: 5.5" Round  
Socket: E26 Dimmer | Bulb: 100 A  
Shade: 8" x 16" x 12"  
**Additional Options:**  
Aqua Crackle | Percalé (AQC-PL)  
Matte Bronze | Percalé (MBZ-PL)

**D SMITH MEDIUM TABLE LAMP**  
CHRISTOPHER SPITZMILLER

**CS3631**  
H: 29.25" | W: 16" | Base: 6" Round  
Socket: E26 Dimmer | Bulb: 100 A  
Shade: 8" x 16" x 12"  
**Additional Options:**  
Aqua Crackle | Percalé (AQC-PL)  
Cinnabar | Percalé (CIN-PL)  
Mixed Blue Brown | Percalé (MBB-PL)

**E CHAMBERS LARGE TABLE LAMP**  
CHRISTOPHER SPITZMILLER

**CS3607**  
H: 34.5" | W: 20" | Base: 7.75" Round  
Socket: E26 Dimmer | Bulb: 100 A  
Shade: 10" x 20" x 14"  
**Additional Options:**  
Cinnabar | Percalé (CIN-PL)  
Ivory | Percalé (IVO-PL)  
Matte Bronze | Percalé (MBZ-PL)

**F SMITH LARGE TABLE LAMP**  
CHRISTOPHER SPITZMILLER

**CS3632**  
H: 33.75" | W: 20" | Base: 7.25" Round  
Socket: E26 Dimmer | Bulb: 100 A  
Shade: 10" x 20" x 14"  
**Additional Options:**  
Aqua Crackle | Percalé (AQC-PL)  
Cinnabar | Percalé (CIN-PL)  
Ivory | Percalé (IVO-PL)  
Matte Bronze | Percalé (MBZ-PL)



**A** **VARNEY MEDIUM TABLE LAMP**  
CHRISTOPHER SPITZMILLER

**CS3642**  
H: 30" | W: 16" | Base: 8" Round  
Socket: E26 Dimmer | Bulb: 100 A  
Shade: 14" x 16" x 13"  
**Available Options:**  
Black Pearl | Linen (BKP-L)



**B** **WHITTAKER MEDIUM TABLE LAMP**  
CHRISTOPHER SPITZMILLER

**CS3646**  
H: 30" | W: 16" | Base: 8" Round  
Socket: E26 Dimmer | Bulb: 100 A  
Shade: 14" x 16" x 13"



**A** **CS3642MBB-L**  
Mixed Blue Brown | Linen



**B** **CS3646BKP-L**  
Black Pearl | Linen



**B** **CS3646IVO-L**  
Ivory | Linen



**B** **CS3646LLC-L**  
Lilac | Linen



**B** **CS3646MBB-L**  
Mixed Blue Brown | Linen



**C** **CS3638IVO-L**  
Ivory | Linen



**C** **CS3638MBZ-L**  
Matte Bronze | Linen



**C** **RALPHAELI LARGE HANDLED TABLE LAMP**  
CHRISTOPHER SPITZMILLER

**CS3638**  
H: 35.5" | W: 20" | Base: 6" Round  
Socket: E26 Dimmer | Bulb: 100 A  
Shade: 18" x 20.5" x 14.5"

**D** **CS3652GSP-L**  
Gold Splatter | Linen



**C** **CS3638AQC-L**  
Aqua Crackle | Linen



**C** **CS3638MBB-L**  
Mixed Blue Brown | Linen



**D** **CS3652BSP-L**  
Blue Splatter | Linen



**D** **BUATTA LARGE TABLE LAMP**  
CHRISTOPHER SPITZMILLER

**CS3652**  
H: 32.5" | W: 19.25" | Base: 8" Round  
Socket: E26 Dimmer | Bulb: 100 A  
Shade: 15.5" x 19.25" x 13"

\* Handmade Ceramics May Have Minor Variations

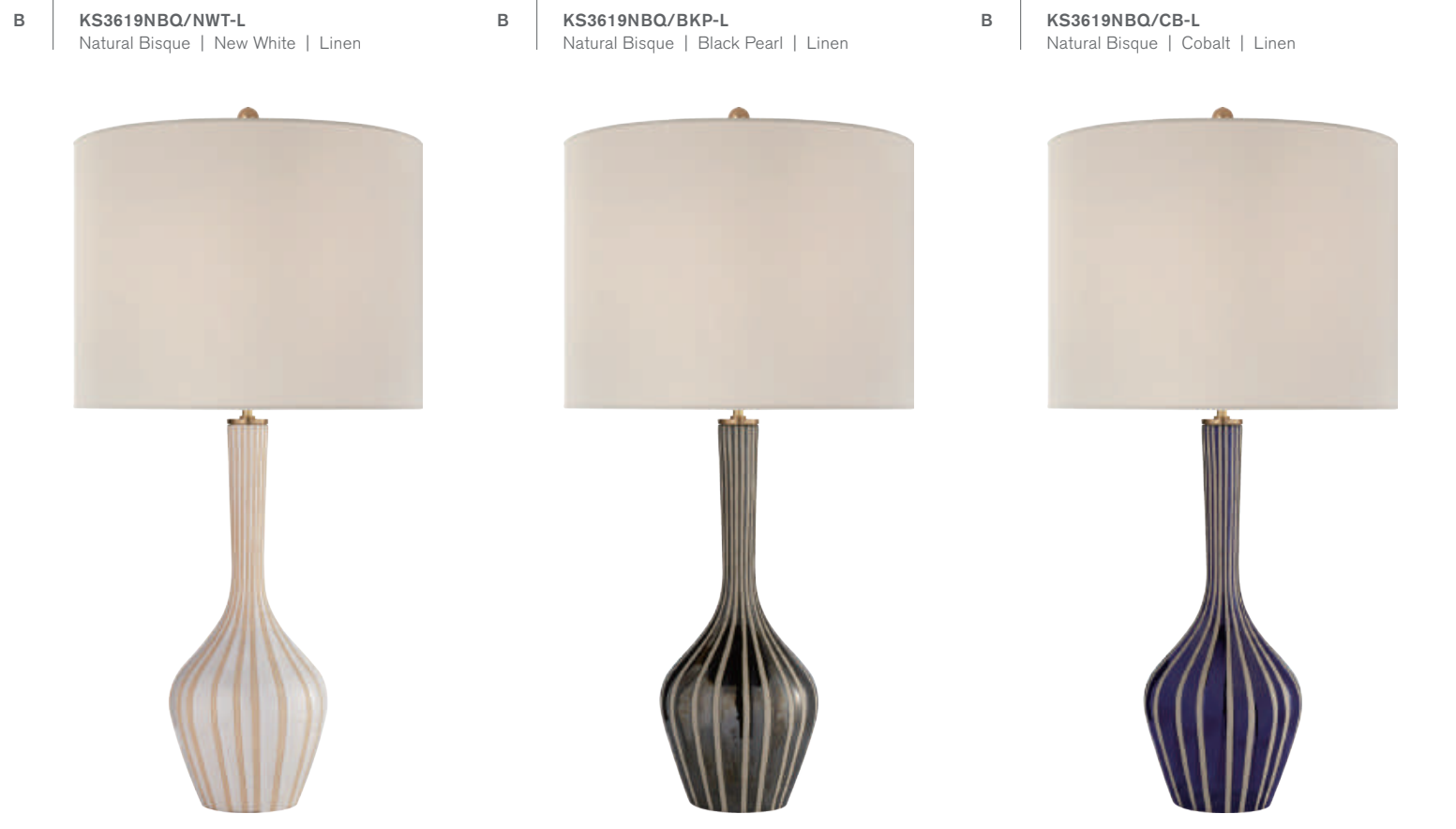
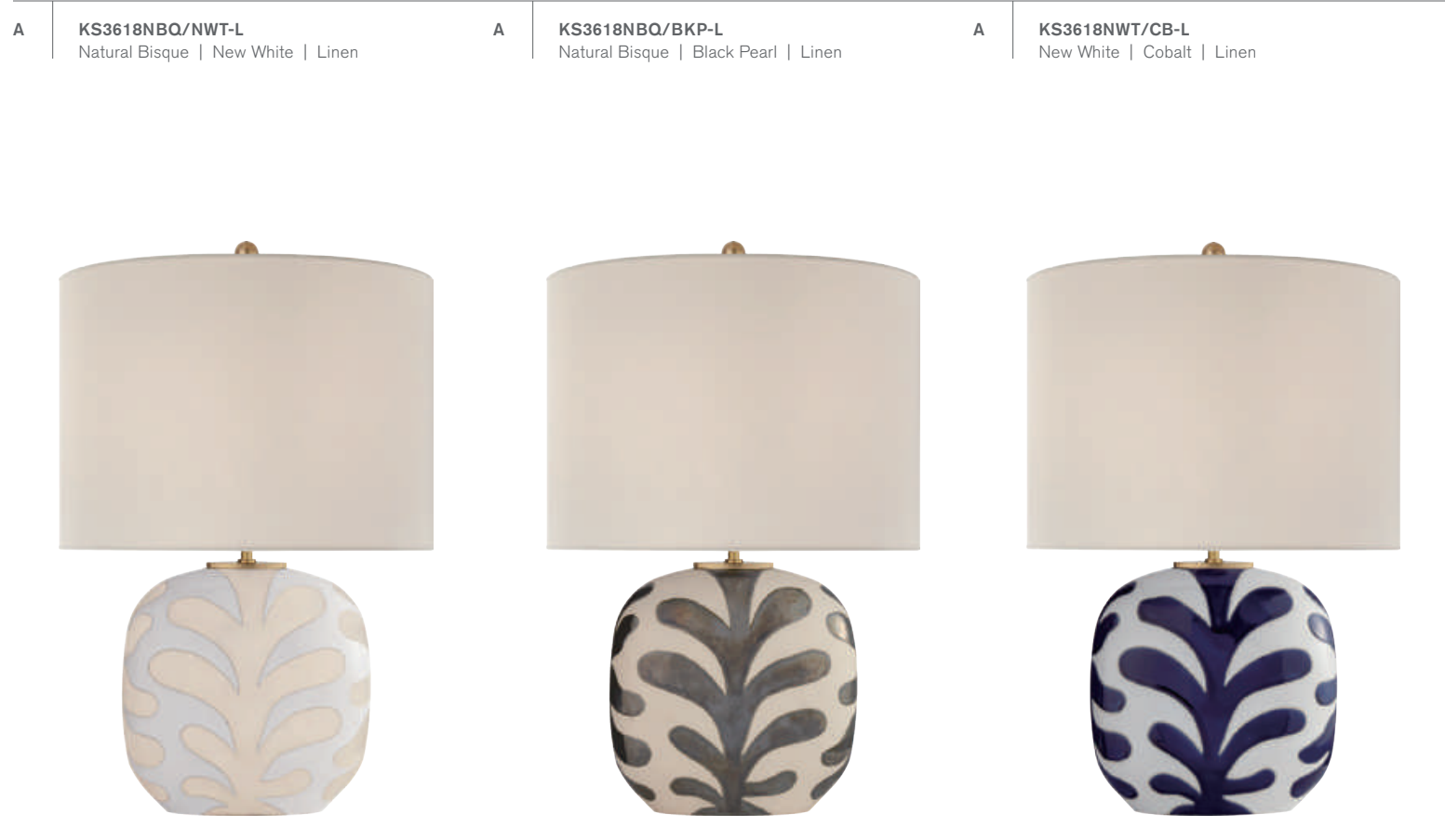

**A** **KS3618NBQ/NWT-L**  
Natural Bisque | New White | Linen

**A** **KS3618NBQ/BKP-L**  
Natural Bisque | Black Pearl | Linen

**A** **KS3618NWT/CB-L**  
New White | Cobalt | Linen

**A** **PARKWOOD MEDIUM TABLE LAMP**  
KATE SPADE NEW YORK

**KS3618**  
H: 23.75" | W: 15" | Base: 3" x 6.5" Oval  
Socket: E26 Keyless | Bulb: 60 A  
Shade: 15" x 15" x 11.25" Oval

**B** **PARKWOOD LARGE TABLE LAMP**  
KATE SPADE NEW YORK

**KS3619**  
H: 30.5" | W: 15.75" | Base: 4.5" Round  
Socket: E26 Keyless | Bulb: 100 A  
Shade: 15.75" x 15.75" x 12"  
\* Line Switch

opposite page

**C** **CORBIN ACCENT LAMP**  
kate spade new york

**KS3101**  
H: 21" | W: 10.75" | Base: 5" Square  
Socket: E26 Keyless | Bulb: 60 A  
Shade: 6.25" x 10.75" x 12.25"  
**Additional Options:**  
Blush | Linen (BLS-L)  
Maraschino | Linen (MSH-L)  
\* Line Switch

\* Handmade Ceramics May Have Minor Variations

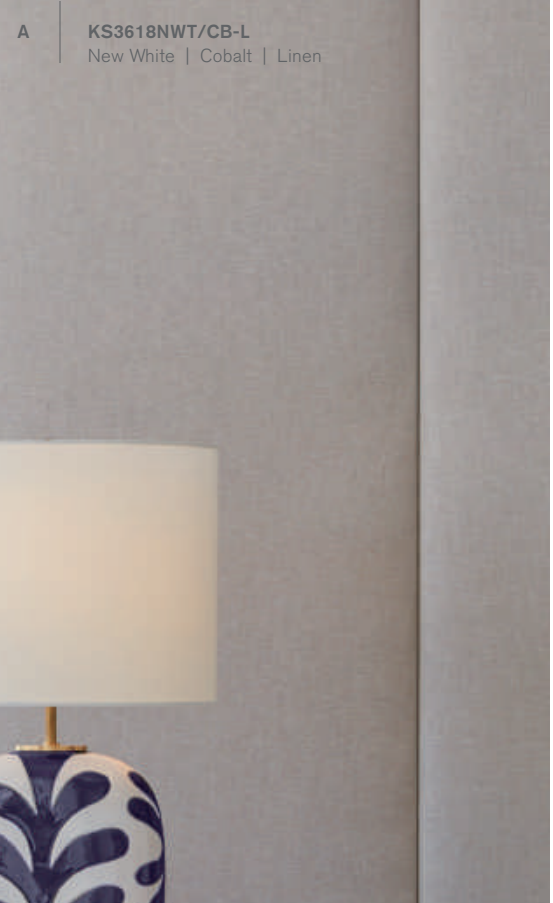

**A** **KS3618NWT/CB-L**  
New White | Cobalt | Linen

**C** **KS3101STU-L**  
Sandy Turquoise | Linen

**C** **KS3101BKP-L**  
Black Pearl | Linen



A | **KS3630MWT-L**  
Matte White | Linen



A | **KS3630EGC-L**  
Emerald Crackle | Linen



A | **KS3630PBC-L**  
Polar Blue Crackle | Linen



opposite page

A | **CARMILLA MEDIUM TABLE LAMP**  
KATE SPADE NEW YORK

**KS3630**  
H: 27.75" | W: 14.5" | Base: 4.25" Square  
Socket: E26 Keyless | Bulb: 100 A  
Shade: 14.5" x 14.5" x 11.5"

B | **KS3634CMH-L**  
Cascading Mocha | Linen



B | **KS3634PMT-L**  
Pale Mint | Linen



B | **KS3634BKP-L**  
Black Pearl | Linen



C | **KS3632SHG-L**  
Shellish Gray | Linen



C | **KS3632EGC-L**  
Emerald Crackle | Linen



C | **KS3632YLC-L**  
Yellow Crackle | Linen



B | **MINOLA MEDIUM TABLE LAMP**  
KATE SPADE NEW YORK

**KS3634**  
H: 25.25" | W: 15.5" | Base: 6" Round  
Socket: E26 Keyless | Bulb: 100 A  
Shade: 15.5" x 15.5" x 9"

C | **GIRY LARGE PEAKED TABLE LAMP**  
KATE SPADE NEW YORK

**KS3632**  
H: 31.75" | W: 16" | Base: 4.75" Round  
Socket: E26 Keyless | Bulb: 100 A  
Shade: 16" x 16" x 11.5"

\* Handmade Ceramics May Have Minor Variations

**A** **KS3616NWT-L**  
New White | Cream Linen



**A** **KS3616DVG-L**  
Dove Grey | Cream Linen



**A** **KS3616BLS-L**  
Blush | Cream Linen



**A** **KS3616STU-L**  
Sandy Turquoise | Cream Linen



**A** **KS3616MTB-L**  
Metallic Black | Cream Linen



**A** **ALBIE SMALL DESK LAMP**  
KATE SPADE NEW YORK

**KS3616**  
H: 25.25" | W: 13.75" | Base: 4" Round  
Socket: E26 In-Line Switch | Bulb: 60 A  
Shade: 13.75" x 13.75" x 12.25"

**B** **KS3617NWT-L**  
New White | Linen



**B** **KS3617DVG-L**  
Dove Grey | Linen



**B** **KS3617BLS-L**  
Blush | Linen



**B** **KS3617STU-L**  
Sandy Turquoise | Linen



**B** **KS3617MTB-L**  
Metallic Black | Linen



**B** **SAXON LARGE TABLE LAMP**  
kate spade new york

**KS3617**  
H: 37.75" | W: 20.5" | Base: 4.25" Round  
Socket: E26 Keyless | Bulb: 100 A  
Shade: 20.5" x 20.5" x 14.5"  
\* Line Switch

\* Handmade Ceramics May Have Minor Variations

A **KS3014CRE-L**  
Cream Glass | Linen



A **KS3014CRE-BL**  
Cream Glass | Black Linen



A **KS3014BLS-L**  
Blush Painted Glass | Linen



opposite page

A **ELSIE MEDIUM TABLE LAMP**  
kate spade new york

**KS3014**  
H: 25.5" | W: 16" | Base: 5" Square  
Socket: E26 Keyless | Bulb: 100 A  
Shade: 16" x 16" x 12"  
**Available Options:**  
Lilac | Linen (LLC-L)  
Yellow | Linen (YL-L)  
\* Line Switch

B **BEEKMAN SMALL TABLE LAMP**  
kate spade new york

**KS3043**  
H: 27.5" | W: 16" | Base: 8" Square  
Socket: E26 Keyless | Bulb: 75 A  
Shade: 16" x 16" x 12"  
\* Line Switch

C **BEEKMAN TABLE LAMP**  
kate spade new york

**KS3044**  
H: 37" | W: 12" | Base: 6" Square  
Socket: E26 Keyless | Bulb: 75 A  
Shade: 12" x 12" x 16"  
\* Line Switch

B **KS3043MSH-PK**  
Maraschino Glass | Pink Linen



B **KS3043GRY-L**  
Grey Glass | Linen



B **KS3043GRN-L**  
Green Glass | Linen



C **KS3044BLS-L**  
Blush Glass | Linen



C **KS3044MSH-PK**  
Maraschino Glass | Pink Linen



C **KS3044GRY-L**  
Grey Glass | Linen



C **KS3044GRN-L**  
Green Glass | Linen



**A** **KS3120MIR/PN-L/PN**  
Mirror | Polished Nickel | Cream Linen



**A** **KS3120MIR/SB-L/SB**  
Mirror | Soft Brass | Cream Linen



**A** **BRADFORD LARGE TABLE LAMP**  
KATE SPADE NEW YORK  
  
**KS3120**  
H: 29.25" | W: 19" | Base: 3.5" x 12.75" Rec.  
Socket: E26 In-Line Switch | Bulb: 100 A  
Shade: 19" x 19" x 13.25" Oval

**B** **KS3945CG/CRE-L**  
Crystal | Cream Accents | Cream Linen



**C** **ELLERY GROS-GRAIN BOW TABLE LAMP**  
kate spade new york  
  
**KS3111**  
H: 22.75" | W: 8" | Base: 5" Square  
Socket: E26 Keyless | Bulb: 60 A  
Shade: 7" x 8" x 8.5" Square  
\* Line Switch

**C** **KS3111PN-L**  
Polished Nickel | Mirror | Linen



**C** **KS3111SB-L**  
Soft Brass | Mirror | Linen



**C** **KS3111SB-BL**  
Soft Brass | Mirror | Black Linen



**D** **DICKINSON BUFFET TABLE LAMP**  
kate spade new york  
  
**KS3005**  
H: 30" | W: 10.25" | Base: 5" Square  
Socket: 7 - E12 Candelabra | Bulb: 7 - 40 G  
\* Line Switch

**E** **RIGA BUFFET LAMP**  
AERIN  
  
**ARN3005**  
H: 33" | W: 10" | Base: 7.5" Round  
Socket: E26 Dimmer | Bulb: 75 A  
Shade: 9.25" x 10" x 8.5"

**A** **KS3120CRE/SB-L/SB**  
Cream | Soft Brass | Cream Linen



**A** **KS3120BLK/SB-L/SB**  
Black | Soft Brass | Cream Linen



**B** **GRAYSON STACKED TABLE LAMP**  
KATE SPADE NEW YORK  
  
**KS3945**  
H: 27.75" | W: 15.5" | Base: 6" Square  
Socket: E26 Keyless | Bulb: 100 A  
Shade: 15.5" x 15.5" x 12.25"

**B** **KS3945CG/BLK-L**  
Crystal | Black and Cream Accents | Cream Linen



**D** **KS3005PN/WM-CG**  
Polished Nickel | White Marble | Clear Glass | Pearls



**D** **KS3005SB/WM-CG**  
Soft Brass | White Marble | Clear Glass | Pearls



**E** **ARN3005CG/PN-L**  
Crystal | Polished Nickel | Linen



**E** **ARN3005CG/HAB-L**  
Crystal | Hand-Rubbed Antique Brass | Linen



A

**BBL3006WG-S**  
White Glass | Silk



A

**MOON GLOW TABLE LAMP**  
BARBARA BARRY

**BBL3006**  
H: 28.5" | W: 17" | Base: 6.5" Round  
Socket: E26 Dimmer | Bulb: 150 A  
Shade: 16" x 17" x 14"  
\* Inside Light 40 A On-Off

B

**LINEHAM TABLE LAMP**  
AERIN

**ARN3024**  
H: 29.5" | W: 18" | Base: 4.5" Round  
Socket: 2 - E26 Keyless | Bulb: 2 - 60 A  
Shade: 18" x 18" x 12.5"  
\* Built-In Dimmer

B

**ARN3024CG/PN-L**  
Crystal | Polished Nickel | Linen

B

**ARN3024CG/HAB-L**  
Crystal | Brass | Linen

B

**ARN3024ALB-L**  
Alabaster | Linen



A

**BBL3006WG-S**  
White Glass | Silk



C

**BROOKS TABLE LAMP**  
J. RANDALL POWERS

**SP3015**  
H: 30" | W: 23" | Base: 8.75" Round  
Socket: E26 Hi-Lo | Bulb: 100 A  
Shade: 5" x 23" x 14"  
\* French Wired

C

**SP3015PN/CG-NP**  
Crystal | Polished Nickel | Natural Paper

C

**SP3015GI/CG-NP**  
Crystal | Gilded Iron | Natural Paper

C

**SP3015AI/CG-NP**  
Crystal | Aged Iron | Natural Paper



**A** **JN3703GMG-L**  
Gold Murano Glass | Linen



**A** **SAZERAC LARGE TABLE LAMP**  
JULIE NEILL

**JN3703**  
H: 29.25" | W: 17" | Base: 5.5" Square  
Socket: E26 Dimmer | Bulb: 100 A  
Shade: 16" x 17" x 10.5"

**B** **TREVISO LARGE TABLE LAMP**  
JULIE NEILL

**JN3701**  
H: 29.75" | W: 19" | Base: 5.5" Square  
Socket: E26 Dimmer | Bulb: 100 A  
Shade: 17" x 19" x 10"

**C** **OPEN BOTTOM GOURD TABLE LAMP**  
E. F. CHAPMAN

**SL3811**  
H: 30" | W: 19" | Base: 6" Round  
Socket: E26 Hi-Lo | Bulb: 150 A  
Shade: 15" x 19" x 12"  
**Additional Options:**  
Clear Glass | Natural Paper (CG-NP)  
©EFC DESIGNS

**B** **JN3701CG-L**  
Clear Glass | Linen



**B** **JN3701WHT-L**  
White



**D** **SL3845MG-NP**  
Antique Mercury Glass | Natural Paper



**A** **JN3703WG-L**  
White Glass | Linen



**D** **BULL NOSE CYLINDER TABLE LAMP**  
E. F. CHAPMAN

**SL3845**  
H: 32" | W: 19" | Base: 9.5" Round  
Socket: E26 Dimmer | Bulb: 150 A  
Shade: 14" x 19" x 13"  
©EFC DESIGNS

**E** **FIONA SMALL TABLE LAMP**  
THOMAS O'BRIEN

**TOB3129**  
H: 29.5" | W: 11" | Base: 4.5" Square  
Socket: E26 Dimmer | Bulb: 150 A  
Shade: 11" x 11" x 12.75"  
**Additional Options:**  
Mercury Glass | Natural Paper (MG-NP)

**F** **FIONA LARGE TABLE LAMP**  
THOMAS O'BRIEN

**TOB3029**  
H: 44.25" | W: 15" | Base: 5.75" Square  
Socket: E26 Dimmer | Bulb: 150 A  
Shade: 15" x 15" x 18.75"  
**Additional Options:**  
White Glass | Natural Paper (WG-NP)

**C** **SL3811MG-NP**  
Mercury Glass | Natural Paper



**C** **SL3811WG-NP**  
White Glass | Natural Paper



**E** **TOB3129WG-NP**  
White Glass | Natural Paper



**F** **TOB3029MG-NP**  
Mercury Glass | Natural Paper





**A** **KS3105ALB-L**  
Alabaster | Linen



**B** **ARN3000BSL-L**  
Burnished Silver Leaf | Linen



**B** **ARN3000CG-L**  
Clear Glass | Linen



**C** **TOB3023CG-NP**  
Crystal | Natural Paper



**C** **TOB3023ALB-NP**  
Alabaster | Natural Paper



opposite page

**A** **ORCHARD MINI ACCENT LAMP**  
kate spade new york

**KS3105**  
H: 16" | W: 8" | Base: 3" Round  
Socket: E12 Candelabra | Bulb: 60 B  
Shade: 8" x 8" x 8"

**B** **MORTON TABLE LAMP**  
AERIN

**ARN3000**  
H: 24.5" | W: 16.5" | Base: 4.5" Round  
Socket: E26 Dimmer | Bulb: 100 A  
Shade: 10" x 16.5" x 12"  
**Additional Options:**  
Gild | Linen (G-L)

**C** **TERRI LARGE ROUND TABLE LAMP**  
THOMAS O'BRIEN

**TOB3023**  
H: 15" | W: 8" | Base: 3" Round  
Socket: E26 Hi-Lo | Bulb: 75 A  
Shade: 5" x 8" x 8"  
\* French Wired  
\* Cannot be Placed in Direct Sunlight

**D** **TERRI SMALL ROUND ACCENT LAMP**  
THOMAS O'BRIEN

**TOB3051**  
H: 10.25" | W: 5" | Base: 2.25" Round  
Socket: E12 Candelabra | Bulb: 40 B  
Shade: 3" x 5" x 5.5"  
**Additional Options:**  
Alabaster | Natural Paper (ALB-NP)  
\* French Wired/Hi-Lo Line Switch  
\* Cannot be Placed in Direct Sunlight

**E** **TERRI MEDIUM ROUND ACCENT LAMP**  
THOMAS O'BRIEN

**TOB3014**  
H: 12.5" | W: 6" | Base: 3" Round  
Socket: E26 Hi-Lo | Bulb: 60 A  
Shade: 4" x 6" x 6"  
**Additional Options:**  
Alabaster | Natural Paper (ALB-NP)  
\* French Wired  
\* Cannot be Placed in Direct Sunlight

**F** **TERRI CUBE ACCENT LAMP**  
THOMAS O'BRIEN

**TOB3020**  
H: 12.5" | W: 6" | Base: 4.5" Square  
Socket: E26 Hi-Lo | Bulb: 60 A  
Shade: 4" x 6" x 6"  
\* French Wired

**D** **TOB3051CG-NP**  
Crystal | Natural Paper



**F** **TOB3020ALB-NP**  
Alabaster | Natural Paper



**E** **TOB3014CG-NP**  
Crystal | Natural Paper



**F** **TOB3020CG-NP**  
Crystal | Natural Paper





**A** | **ARN3100CG-L**  
Clear Glass | Linen

**A** | **CANNES TABLE LAMP**  
AERIN  
  
**ARN3100**  
H: 31" | W: 17" | Base: 8.25" Decorative  
Socket: E26 Dimmer | Bulb: 150 A  
Shade: 17" x 17" x 12.5"  
\* French Wired

**B** | **QUATTRO TABLE LAMP**  
E. F. CHAPMAN  
  
**CHA8974**  
H: 29" | W: 19" | Base: 4.5" x 11" Rec.  
Socket: E26 Dimmer | Bulb: 150 A  
Shade: 15" x 19" x 12"  
\* French Wired  
©EFC DESIGNS

**C** | **RING FORM SMALL TABLE LAMP**  
E. F. CHAPMAN  
  
**CHA8969**  
H: 20" | W: 13.5" | Base: 4" x 5.5" Rec.  
Socket: E26 Hi-Lo | Bulb: 75 A  
Shade: 10.5" x 13.5" x 8.5" Rec.  
\* French Wired  
©EFC DESIGNS

**D** | **RING FORM LARGE TABLE LAMP**  
E. F. CHAPMAN  
  
**CHA8970**  
H: 26" | W: 18" | Base: 4.5" x 7.5" Rec.  
Socket: E26 Dimmer | Bulb: 100 A  
Shade: 14" x 18" x 11" Rec.  
\* French Wired  
©EFC DESIGNS



**B** | **CHA8974ALB-NP**  
Alabaster | Natural Paper

opposite page  
**E** | **VERSA LARGE TABLE LAMP**  
JULIE NEILL  
  
**JN3903**  
H: 29" | W: 18" | Base: 5" Square  
Socket: E26 Dimmer | Bulb: 100 A  
Shade: 15" x 18" x 12.5"  
\* Alabaster is a Natural Stone  
\* Variations in Color and Texture are Expected

**F** | **DANI MEDIUM TABLE LAMP**  
THOMAS O'BRIEN  
  
**TOB3980**  
H: 27.5" | W: 16" | Base: 5" x 7.25" Rec.  
Socket: E26 Dimmer | Bulb: 100 A  
Shade: 14.25" x 15.75" x 10.25" Oval



**C** | **CHA8969CG-NP**  
Crystal | Natural Paper



**C** | **CHA8969ALB-NP**  
Alabaster | Natural Paper



**D** | **CHA8970CG-NP**  
Crystal | Natural Paper



**D** | **CHA8970ALB-NP**  
Alabaster | Natural Paper



**E** | **JN3903ALB-L**  
Alabaster | Linen



**F** | **TOB3980ALB-L**  
Alabaster | Linen



**F** | **TOB3980ALB/BM-L**  
Alabaster | Black Marble | Linen

**A** **TOB3916PN/CG-PL**  
Polished Nickel | Crystal | Natural Percalé



**A** **TOB3916HAB/CG-PL**  
Brass | Crystal | Natural Percalé



**A** **MOREAU MEDIUM TABLE LAMP**  
THOMAS O'BRIEN

**TOB3916**  
H: 26" | W: 9.25" | Base: 7.25" Square  
Socket: E26 Pull Chain | Bulb: 60 A  
Shade: 8.25" x 9.25" x 11.5" Square

**B** **MOREAU LARGE TABLE LAMP**  
THOMAS O'BRIEN

**TOB3917**  
H: 31.25" | W: 13" | Base: 7.25" Square  
Socket: E26 Pull Chain | Bulb: 100 A  
Shade: 12" x 13" x 15" Square

**C** **S3945CG/PN**  
Crystal | Polished Nickel



**D** **S3940CG/PN-L**  
Crystal | Polished Nickel | Linen



**C** **S3945CG/HAB**  
Crystal | Brass

**B** **TOB3917PN/CG-PL**  
Polished Nickel | Crystal | Natural Percalé



**B** **TOB3917HAB/CG-PL**  
Brass | Crystal | Natural Percalé



**C** **AMBAR SMALL TABLE LIGHT**  
IAN K. FOWLER

**S3945**  
H: 11" | W: 11" | Base: 4" x 11" Rec.  
Socket: E26 Hi-Lo | Bulb: 40 T

**D** **FARO LARGE TABLE LAMP**  
IAN K. FOWLER

**S3940**  
H: 30" | W: 18" | Base: 4.25" Square  
Socket: E26 Dimmer | Bulb: 100 A  
Shade: 18" x 18" x 10"



**A TOB3031CG-C**  
Crystal | Polished Silver | Cotton



**B TOB3030CG-C**  
Crystal | Polished Silver | Cotton



**A CRYSTAL BLOCK TABLE LAMP**  
THOMAS O'BRIEN

**TOB3031**  
H: 18" - 19.5" | W: 11.5" | Base: 4" x 6" Rec.  
Socket: 2 - E26 Pull Chain | Bulb: 2 - 40 B  
Shade: 11.5" x 11.5" x 8"

**B CRYSTAL BLOCK LARGE TABLE LAMP**  
THOMAS O'BRIEN

**TOB3030**  
H: 24" - 26" | W: 16.75" | Base: 6" x 9" Rec.  
Socket: 2 - E26 Pull Chain | Bulb: 2 - 60 A  
Shade: 15" x 16.75" x 10.5" Oval

**C HENRI LARGE FRAMED TABLE LAMP**  
SUZANNE KASLER

**SK3035**  
H: 29" | W: 16" | Base: 6.5" x 5.25" Rec.  
Socket: E26 Dimmer | Bulb: 100 A  
Shade: 13" x 16" x 9.5"

**D CRYSTAL PANEL TABLE LAMP**  
E. F. CHAPMAN

**CHA8983**  
H: 29.5" | W: 16" | Base: 4.75" x 9.75" Rec.  
Socket: E26 Dimmer | Bulb: 150 A  
Shade: 15" x 16" x 12" Rec.  
**Additional Options:**  
Sheffield Nickel | Natural Paper (SN-NP)  
\* French Wired  
©EFC DESIGNS

opposite page

**E WRIGHT TABLE LAMP**  
STUDIO VC

**S3701**  
H: 33" | W: 17" | Base: 4.5" x 7.5" Rec.  
Socket: E26 Hi-Lo | Bulb: 150 A  
Shade: 12.5" x 17" x 10" Rec.

**C SK3035PN-L**  
Polished Nickel | Linen



**C SK3035HAB-L**  
Hand-Rubbed Antique Brass | Linen



**D CHA8983PN-NP**  
Crystal | Polished Nickel | Natural Paper



**D CHA8983AB-NP**  
Crystal | Antique-Burnished Brass | Natural Paper



**D CHA8983AB-NP**  
Crystal | Antique-Burnished Brass | Natural Paper



**E S3701PN-NP**  
Polished Nickel | Glass | Natural Paper



**E S3701GI-NP**  
Gilded Iron | Glass | Natural Paper



**A** | **MS3002Q-NP**  
Quartz | Antique Gold Leaf | Natural Paper



**B** | **TOB3940PN-L**  
Polished Nickel | Linen



**B** | **TOB3940BZ/HAB-L**  
Bronze | Hand-Rubbed Antique Brass | Linen



**C** | **SP3005CG-NP**  
Crystal | Polished Nickel | Natural Paper



**C** | **SP3005Q/BSL-NP**  
Quartz | Burnished Silver Leaf | Natural Paper



**C** | **SP3005CG/GI-NP**  
Crystal | Gilded Iron | Natural Paper



**C** | **SP3005Q-NP**  
Quartz | Gilded Iron | Natural Paper



opposite page

**A** | **CRESCENT TABLE LAMP**  
MICHAEL S SMITH

**MS3002**  
H: 27" | W: 18" | Base: 3.25" x 9" Rec.  
Socket: 2 - E26 Pull Chain | Bulb: 2 - 60 A  
Shade: 15" x 18" x 11.75" Rec.  
**Additional Options:**  
Quartz | Antique Silver Leaf | Natural Paper (QS-NP)

**B** | **PORTO MEDIUM TABLE LAMP**  
THOMAS O'BRIEN

**TOB3940**  
H: 26.25" | W: 15" | Base: 6.75" x 8.5" Rec.  
Socket: 2 - E26 Pull Chain | Bulb: 2 - 60 A  
Shade: 15" x 15" x 9.5" Rec.

**D** | **TOB3195GI-NP**  
Gilded Iron | Quartz | Natural Paper



**E** | **ARN3030HAB-L**  
Hand-Rubbed Antique Brass | Quartz | Linen



**C** | **CAMERON TABLE LAMP**  
J. RANDALL POWERS

**SP3005**  
H: 28" | W: 17" | Base: 12" Cross  
Socket: E26 Hi-Lo | Bulb: 150 A  
Shade: 13" x 17" x 11"

**D** | **SILHOUETTE VASE ACCENT LAMP**  
THOMAS O'BRIEN

**TOB3195**  
H: 21.5" | W: 7.5" | Base: 3.5" x 5" Rec.  
Socket: 2 - E12 Candelabra | Bulb: 2 - 40 B  
Shade: 7" x 7.5" x 9"  
**Additional Options:**  
Burnished Silver Leaf | Quartz | Natural Paper (BSL-NP)  
\* Switch on Base

**E** | **TRIESTE LARGE TABLE LAMP**  
AERIN

**ARN3030**  
H: 29.25" | W: 17" | Base: 5.5" Square  
Socket: E26 Dimmer | Bulb: 150 A  
Shade: 13" x 17" x 13" Rec.  
**Additional Options:**  
Burnished Silver Leaf | Quartz | Linen (BSL-L)

**A** **CASTLE PEAK LARGE TABLE LAMP**  
kate spade new york

**KS3065**  
H: 38" | W: 16.5" | Base: 7" Square  
Socket: E26 Keyless | Bulb: 100 A  
Shade: 16.5" x 16.5" x 13.25"  
\* Line Switch  
\* French Wired

**A** **KS3065CG-L**  
Crystal | Linen



**A** **KS3065CG-BL**  
Crystal | Black Linen



**B** **KS3925CG-L**  
Crystal | Linen



**C** **KS3064CG-L**  
Crystal | Cream Linen



**B** **CASTLE PEAK BEDSIDE LAMP**  
kate spade new york

**KS3925**  
H: 21.5" | W: 11" | Base: 3.25" Round  
Socket: E26 Keyless | Bulb: 75 A  
Shade: 8.5" x 11" x 13.25"  
\* Line Switch

**C** **CASTLE PEAK NARROW TABLE LAMP**  
KATE SPADE NEW YORK

**KS3064**  
H: 34" | W: 14" | Base: 7" Square  
Socket: E26 In-Line Switch | Bulb: 100 A  
Shade: 14" x 14" x 11"  
\* French Wired

**D** **OCTAGONAL SPIRE MEDIUM TABLE LAMP**  
E. F. CHAPMAN

**CHA8950**  
H: 25" | W: 13.5" | Base: 3.5" Oct.  
Socket: E26 Dimmer | Bulb: 150 A  
Shade: 11" x 13.5" x 9"  
\* French Wired  
\* Cannot be Placed in Direct Sunlight  
©EFC DESIGNS

**E** **OCTAGONAL SPIRE LARGE TABLE LAMP**  
E. F. CHAPMAN

**CHA8951**  
H: 31.5" | W: 17" | Base: 4.5" Oct.  
Socket: E26 Dimmer | Bulb: 150 A  
Shade: 13" x 17" x 10"  
\* French Wired  
©EFC DESIGNS

**F** **LILA TABLE LAMP**  
ALEXA HAMPTON

**AH3050**  
H: 34" | W: 17.25" | Base: 7.25" X Shape  
Socket: E26 Dimmer | Bulb: 100 A  
Shade: 9" x 17.25" x 12.75"

**D** **CHA8950CG-NP**  
Crystal | Natural Paper



**F** **AH3050CG/BSL-PL**  
Crystal | Burnished Silver Leaf | Percale



**E** **CHA8951CG-NP**  
Crystal | Natural Paper



**F** **AH3050CG/G-PL**  
Crystal | Gild | Percale



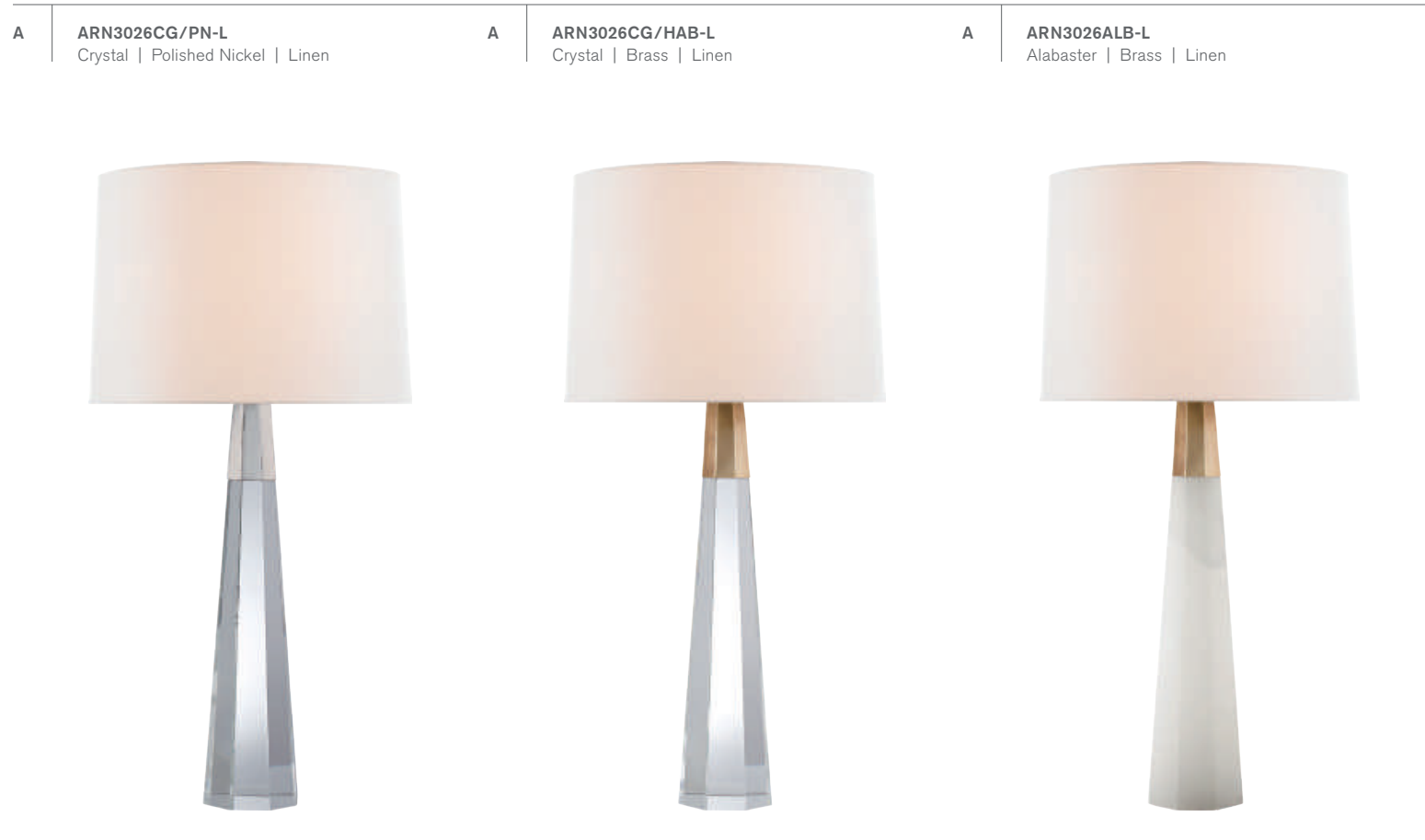

**A** | **ARN3026CG/PN-L**  
Crystal | Polished Nickel | Linen

**A** | **ARN3026CG/HAB-L**  
Crystal | Brass | Linen

**A** | **ARN3026ALB-L**  
Alabaster | Brass | Linen

**A** | **OLSEN TABLE LAMP**  
AERIN

**ARN3026**  
H: 32.5" | W: 17" | Base: 5" Oct.  
Socket: 2 - E26 Keyless | Bulb: 2 - 60 A  
Shade: 16" x 17" x 12"  
\* Dimmer

**B** | **ROBINSON BUFFET LAMP**  
THOMAS O'BRIEN

**TOB3932**  
H: 36.75" | W: 10.5" | Base: 6" Round  
Socket: E26 Keyless | Bulb: 75 A  
Shade: 10.5" x 10.5" x 13.5"  
\* Line Switch

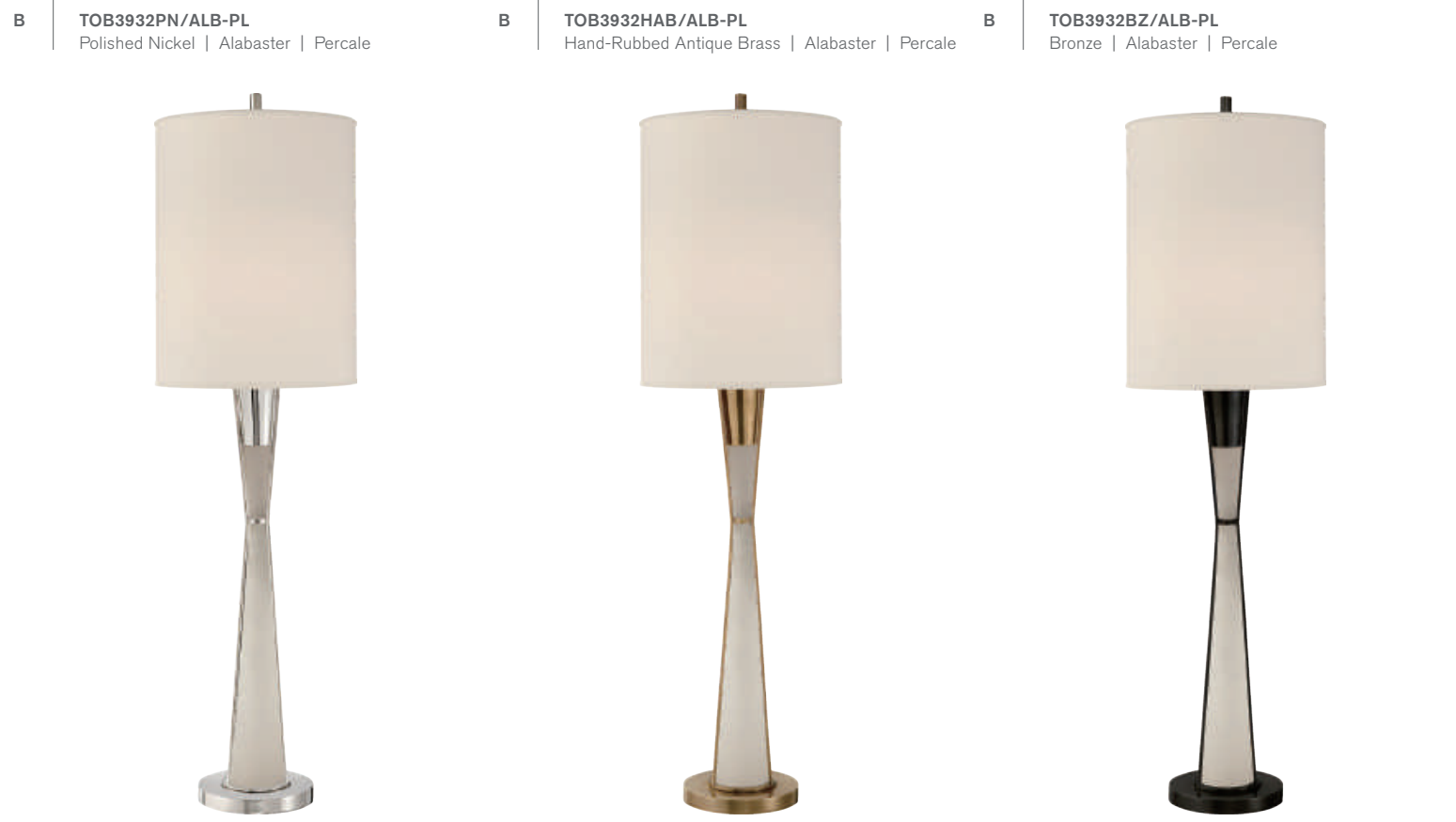

**B** | **TOB3932PN/ALB-PL**  
Polished Nickel | Alabaster | Percalé

**B** | **TOB3932HAB/ALB-PL**  
Hand-Rubbed Antique Brass | Alabaster | Percalé

**B** | **TOB3932BZ/ALB-PL**  
Bronze | Alabaster | Percalé

opposite page

**C** | **ADELINE LARGE QUATREFOIL TABLE LAMP**  
SUZANNE KASLER

**SK3906**  
H: 32" | W: 17" | Base: 5.5" Decorative  
Socket: E26 Dimmer | Bulb: 100 A  
Shade: 15" x 17" x 10.5"

**D** | **CHLOE TABLE LAMP**  
SUZANNE KASLER

**SK3900**  
H: 21.25" | W: 12" | Base: 4.5" Round  
Socket: E26 Dimmer | Bulb: 100 A  
Shade: 10" x 12" x 7.5"  
\* French Wired

**E** | **CHLOE TALL TABLE LAMP**  
SUZANNE KASLER

**SK3901**  
H: 29" | W: 17" | Base: 6" Round  
Socket: E26 Dimmer | Bulb: 100 A  
Shade: 13" x 17" x 10"  
\* French Wired



**C** | **SK3906ALB-L**  
Alabaster | Linen

**D** | **SK3900CG-S**  
Crystal | Silk

**E** | **SK3901CG-S**  
Crystal | Silk



**A** **TOB3627HAB/CG-L**  
Hand-Rubbed Antique Brass | Crystal | Linen



**A** **TOB3627BZ/ALB-L**  
Bronze | Alabaster | Linen



**C** **TOB3240HAB/ALB-L**  
Hand-Rubbed Antique Brass | Alabaster | Linen



opposite page

**A** **LEXINGTON MEDIUM TABLE LAMP**  
THOMAS O'BRIEN

**TOB3627**  
H: 31.75" | W: 9.25" | Base: 6" Square  
Socket: E26 Pull Chain | Bulb: 60 A  
Shade: 8.25" x 9.25" x 10.75" Square  
**Additional Options:**  
Bronze | Crystal | Linen (BZ/CG-L)  
Polished Nickel | Crystal | Linen (PN/CG-L)

**B** **TOB3241PN/CG-L**  
Polished Nickel | Crystal | Linen



**B** **TOB3241HAB/ALB-L**  
Hand-Rubbed Antique Brass | Alabaster | Linen



**B** **TOB3241BZ/ALB-L**  
Bronze | Alabaster | Linen



**C** **TOB3240PN/CG-L**  
Polished Nickel | Crystal | Linen



**C** **TOB3240HAB/ALB-L**  
Hand-Rubbed Antique Brass | Alabaster | Linen



**C** **TOB3240BZ/ALB-L**  
Bronze | Alabaster | Linen



**B** **CASPER SMALL DESK LAMP**  
THOMAS O'BRIEN

**TOB3241**  
H: 13" | W: 18" | Base: 5.75" Oval  
Socket: 2 - E26 On-Off | Bulb: 2 - 40 B  
Shade: 18" x 18" x 8" Oval

**C** **CASPER MEDIUM TABLE LAMP**  
THOMAS O'BRIEN

**TOB3240**  
H: 27" | W: 18" | Base: 5.75" x 16.25" Oval  
Socket: 2 - E26 On-Off | Bulb: 2 - 40 B  
Shade: 18" x 18" x 9" Oval





**A** | **ARN3036ALB-L**  
Alabaster | Linen

**B** | **TOB3011ALB-L**  
Alabaster | Linen

**A** | **YVETTE TABLE LAMP**  
AERIN  
  
**ARN3036**  
H: 30.25" | W: 22" | Base: 7.25" Round  
Socket: 2 - E26 Keyless | Bulb: 2 - 60 A  
Shade: 21.5" x 22" x 12"  
**Additional Options:**  
Limestone | Linen (LIM-L)  
\* Built-In Dimmer

**B** | **LONDON COLUMN TABLE LAMP**  
THOMAS O'BRIEN  
  
**TOB3011**  
H: 38.25" | W: 19.5" | Base: 7" Round  
Socket: 2 - E26 Pull Chain | Bulb: 2 - 60 A  
Shade: 17" x 18" x 13.5"

**C** | **BIAS COLUMN LARGE TABLE LAMP**  
E. F. CHAPMAN  
  
**CHA8679**  
H: 31" | W: 20" | Base: 6.5" Square  
Socket: E26 Dimmer | Bulb: 150 A  
Shade: 19" x 20" x 12.5" Square

**D** | **RECTANGULAR STACKED TABLE LAMP**  
E. F. CHAPMAN  
  
**CHA8960**  
H: 24" | W: 13.5" | Base: 5" x 6.5" Rec.  
Socket: E26 Hi-Lo | Bulb: 100 A  
Shade: 8.5" x 13.5" x 9" Rec.  
©EFC DESIGNS

**E** | **ROUND CHUNKY STACKED TABLE LAMP**  
E. F. CHAPMAN  
  
**CHA8945**  
H: 29.5" | W: 16" | Base: 5" Round  
Socket: E26 Dimmer | Bulb: 150 A  
Shade: 14" x 16" x 12"  
©EFC DESIGNS

**F** | **SQUARE CHUNKY STACKED TABLE LAMP**  
E. F. CHAPMAN  
  
**CHA8947**  
H: 31" | W: 16" | Base: 5" Square  
Socket: E26 Dimmer | Bulb: 150 A  
Shade: 14" x 16" x 12" Square  
©EFC DESIGNS



**C** | **CHA8679ALB-PL**  
Alabaster | Natural Percale

**E** | **CHA8945ALB-NP**  
Alabaster | Natural Paper



**D** | **CHA8960ALB-NP**  
Alabaster | Natural Paper

**F** | **CHA8947ALB-NP**  
Alabaster | Natural Paper



**G** | **TOB3095ALB-NP**  
Alabaster | Natural Paper

**G** | **TINA TABLE LAMP**  
THOMAS O'BRIEN  
  
**TOB3095**  
H: 34.5" | W: 13" | Base: 8" Triangle  
Socket: 2 - E26 Pull Chain | Bulb: 2 - 60 A  
Shade: 12" x 13" x 14"  
\* French Wired

**H** | **MICHELANGELO BUFFET LAMP**  
THOMAS O'BRIEN  
  
**TOB3362**  
H: 31" | W: 13" | Base: 6.5" X 7.5" Rec.  
Socket: 2 - E26 Pull Chain | Bulb: 2 - 60 A  
Shade: 13" x 13" x 7.75"



**H** | **TOB3362ALB-NP**  
Alabaster | Natural Paper

A | **ARN3004BRM-L**  
Brown Marble | Linen



A | **ARN3004BM-L**  
Black Marble | Linen



A | **ARN3004GRM-L**  
Green Marble | Linen



B | **KW3109AB-ALB**  
Antique-Burnished Brass | Alabaster



B | **KW3109BZ-ALB**  
Bronze | Alabaster



C | **KW3010AB-ALB**  
Antique-Burnished Brass | Alabaster



C | **KW3010BZ-ALB**  
Bronze | Alabaster



opposite page

A | **CLIFF TABLE LAMP**  
AERIN

**ARN3004**  
H: 30" | W: 17" | Base: 5.5" Round  
Socket: E26 Dimmer | Bulb: 150 A  
Shade: 17" x 17" x 12.5"

D | **KW3920WM-AB**  
White Marble | Antique-Burnished Brass



D | **KW3920BM-PN**  
Black Marble | Polished Nickel



B | **MELANGE DESK LAMP**  
KELLY WEARSTLER

**KW3109**  
H: 18" | W: 12.25" | Base: 8.5" Round  
Socket: E26 Keyless | Bulb: 12 LED - A  
\* Built-In Dimmer

C | **MELANGE TABLE LAMP**  
KELLY WEARSTLER

**KW3010**  
H: 23" | W: 16.25" | Base: 12" Round  
Socket: E26 Keyless | Bulb: 14.5 LED A  
\* Built-In Dimmer

D | **AFFINITY MEDIUM DOME TABLE LAMP**  
KELLY WEARSTLER

**KW3920**  
H: 22" | W: 15" | Base: 5" Round  
Socket: 3 - E12 | Bulb: 3 - 40 B

**A** | **KW3047ALB-AB**  
Alabaster | Antique-Burnished Brass



**A** | **KW3047BM-AB**  
Black Marble | Antique-Burnished Brass



**A** | **MINIMALIST MEDIUM TABLE LAMP**  
KELLY WEARSTLER

**KW3047**  
H: 25" | W: 20" | Base: 4.5" Round  
Socket: 3 - E12 Candelabra | Bulb: 3- 25 B

**B** | **HALCYON ACCENT LAMP**  
KELLY WEARSTLER

**KW3012**  
H: 25" | W: 8" | Base: 2.75" Round  
Socket: E26 On-Off | Bulb: 75 A  
Shade: 5.5" x 8" x 12.25"  
**Additional Options:**  
Black Crema Marble | Linen (BM-L)  
\* French Wired

**B** | **KW3012CG-L**  
Crystal | Linen



**B** | **KW3012Q-AB**  
Quartz | Antique Brass



**B** | **KW3012ALB-L**  
Alabaster | Linen



**B** | **KW3012BM-AB**  
Black Marble | Brass



**C** | **EVOKE LARGE TABLE LAMP**  
KELLY WEARSTLER

**KW3040**  
H: 30.25" | W: 18" | Base: 7.5" Square  
Socket: E26 Dimmer | Bulb: 100 A  
Shade: 13" x 18" x 12.25"

**D** | **HALCYON CONSOLE LAMP**  
KELLY WEARSTLER

**KW3091**  
H: 18" | W: 6" | Base: 6" Square  
Socket: E12 Candelabra | Bulb: 60 B  
\* Switch on Base

**C** | **KW3040ALB-L**  
Alabaster | Linen



**D** | **KW3091Q-AB**  
Natural Quartz | Brass | Brass



**A LEIGH TABLE LAMP**  
SUZANNE KASLER

**SK3902**  
H: 36.5" | W: 19" | Base: 6.5" Square  
Socket: E26 Hi-Lo | Bulb: 100 A  
Shade: 14" x 19" x 11"  
\* French Wired  
\* Cannot be Placed in Direct Sunlight

**B JULIETTE TABLE LAMP**  
SUZANNE KASLER

**SK3905**  
H: 30" | W: 16" | Base: 8" Square  
Socket: 2 - E26 Pull Chain | Bulb: 2 - 60 A  
Shade: 14.25" x 16" x 11"  
\* French Wired

**A SK3902CG-S**  
Crystal | Gild | Silk



**B SK3905CG-S**  
Crystal | Gild | Silk



**C JN3011VW-L**  
Vintage White | Gild | Linen



**E TOB3452BCO-L**  
Blonde Cerused Oak | Linen



**D JN3010VWG-L**  
Vintage White | Gild | Linen



**F AH3100ALB-NP**  
Alabaster | Natural Paper



**C CAPRIVA LARGE TABLE LAMP**  
JULIE NEILL

**JN3011**  
H: 29.75" | W: 15" | Base: 7" x 5" Rec.  
Socket: E26 Dimmer | Bulb: 100 A  
Shade: 14" x 15" x 10.5"  
**Additional Options:**  
Antique Gold Leaf | Linen (AGL-L)

**D AMPHORA TABLE LAMP**  
JULIE NEILL

**JN3010**  
H: 29.5" | W: 22" | Base: 7.5" Square  
Socket: E26 Dimmer | Bulb: 100 A  
Shade: 9" x 22" x 12.25"

**E PIAF MEDIUM TABLE LAMP**  
THOMAS O'BRIEN

**TOB3452**  
H: 22.75" | W: 18" | Base: 6.25" Square  
Socket: E26 Keyless | Bulb: 60 A  
Shade: 8" x 18" x 11.25"

**F DESMOND TABLE LAMP**  
ALEXA HAMPTON

**AH3100**  
H: 26" | W: 18" | Base: 7.5" Square  
Socket: E26 Dimmer | Bulb: 150 A  
Shade: 10" x 18" x 12"  
**Additional Options:**  
Garden Stone | Natural Paper (GS-NP)

**G CHUNKY CLASSIC URN TABLE LAMP**  
E. F. CHAPMAN

**CHA8359**  
H: 29" | W: 17" | Base: 7.25" Round  
Socket: E26 Dimmer | Bulb: 150 A  
Shade: 13" x 17" x 10"  
©EFC DESIGNS

**H CHUNKY URN LARGE TABLE LAMP**  
E. F. CHAPMAN

**CHA8174**  
H: 37.5" | W: 21" | Base: 8.25" Square  
Socket: E26 Dimmer | Bulb: 150 A  
Shade: 19" x 21" x 14"  
©EFC DESIGNS

**G CHA8359WGL-NP**  
Weathered White Gold | Natural Paper



**H CHA8174ALB-NP**  
Alabaster | Natural Paper



**A** **CHA8924ALB-NP**  
Alabaster | Natural Paper



**A** **CHA8924CG-NP**  
Crystal | Natural Paper



**A** **BALUSTRADE TABLE LAMP**  
E. F. CHAPMAN  
  
**CHA8924**  
H: 27" | W: 17" | Base: 5.5" Square  
Socket: E26 Hi-Lo | Bulb: 150 A  
Shade: 13" x 17" x 10"  
**Additional Options:**  
Crystal | Silk Pleat (CG-SBP)  
\* French Wired  
\* Cannot be Placed in Direct Sunlight  
©EFC DESIGNS

**B** **CONTEMPORARY BALUSTRADE TABLE LAMP**  
E. F. CHAPMAN

**CHA8646**  
H: 30" | W: 16" | Base: 5" Square  
Socket: E26 Dimmer | Bulb: 150 A  
Shade: 14" x 16" x 10.75"  
\* French Wired  
\* Cannot be Placed in Direct Sunlight  
©EFC DESIGNS

**C** **CHA8651CG-NP**  
Crystal | Natural Paper



**D** **CHA8710CG-NP**  
Crystal | Natural Paper



**C** **GEOMETRIC TALL TABLE LAMP**  
E. F. CHAPMAN

**CHA8651**  
H: 31" | W: 17" | Base: 4.75" Square  
Socket: E26 Dimmer | Bulb: 150 A  
Shade: 13" x 17" x 10"  
\* French Wired  
\* Cannot be Placed in Direct Sunlight  
©EFC DESIGNS

**D** **GUSTAVIAN BUFFET LAMP**  
E. F. CHAPMAN

**CHA8710**  
H: 34.25" | W: 14" | Base: 5" Square  
Socket: E26 Dimmer | Bulb: 60 A  
Shade: 7" x 14" x 8.5"  
\* French Wired  
©EFC DESIGNS

**B** **CHA8646ALB-NP**  
Alabaster | Natural Paper



**B** **CHA8646CG-NP**  
Crystal | Natural Paper



**E** **CHA8917CG-NP**  
Crystal | Natural Paper



**E** **MODERN BALUSTRADE TABLE LAMP**  
E. F. CHAPMAN

**CHA8917**  
H: 33" | W: 19" | Base: 7.5" Square  
Socket: E26 Dimmer | Bulb: 150 A  
Shade: 15" x 19" x 12"  
\* French Wired  
\* Cannot be Placed in Direct Sunlight  
©EFC DESIGNS

**F** **SLENDER COLUMN TABLE LAMP**  
E. F. CHAPMAN

**CHA8926**  
H: 30" | W: 17" | Base: 6" Square  
Socket: E26 Hi-Lo | Bulb: 150 A  
Shade: 13" x 17" x 10"  
\* French Wired  
©EFC DESIGNS

**F** **CHA8926CG-NP**  
Crystal | Natural Paper





A **CHA8906GI-NP**  
Gilded Iron | Natural Paper

A **CHA8906WHT-NP**  
Matte White | Natural Paper



A **CHA8906BZV-NP**  
Bronze Verdigris | Natural Paper



opposite page

A **FLUTED SPIRE LARGE TABLE LAMP**  
E. F. CHAPMAN

**CHA8906**  
H: 31.5" | W: 17" | Base: 4.25" Round  
Socket: E26 Dimmer | Bulb: 150 A  
Shade: 13" x 17" x 10"  
**Additional Options:**  
Aged Iron | Natural Paper (AI-NP)  
©EFC DESIGNS

B **STRIE TABLE LAMP**  
E. F. CHAPMAN

**CHA8707**  
H: 29.75" | W: 17" | Base: 5.25" x 8" Rec.  
Socket: E26 Hi-Lo | Bulb: 100 A  
Shade: 9" x 17" x 11"  
©EFC DESIGNS

C **STRIE BUFFET LAMP**  
E. F. CHAPMAN

**CHA8463**  
H: 31.5" | W: 10" | Base: 4" x 6" Rec.  
Socket: E26 Keyless | Bulb: 60 B  
Shade: 3.5" x 10" x 7" Square  
\* Hi-Lo Line Switch  
©EFC DESIGNS

C **CHA8463WHT-NP**  
Matte White | Natural Paper



B **CHA8707WHT-NP**  
Matte White | Natural Paper



B **CHA8707GI-NP**  
Gilded Iron | Natural Paper



B **CHA8707AI-NP**  
Aged Iron | Natural Paper



C **CHA8463G-NP**  
Gild | Natural Paper



C **CHA8463GI-NP**  
Gilded Iron | Natural Paper



C **CHA8463AI-NP**  
Aged Iron | Natural Paper



**A** **TOB3152GI-NP**  
Gilded Iron | Natural Paper



**A** **PARISH BUFFET LAMP**  
THOMAS O'BRIEN

**TOB3152**  
H: 31.5" | W: 11.5" | Base: 9.5" Tripod  
Socket: 2 - E26 Pull Chain | Bulb: 2 - 40 B  
Shade: 9" x 11.5" x 10"

**B** **S3400GI-NP**  
Gilded Iron | Natural Paper



**B** **S3400AI-NP**  
Aged Iron | Natural Paper



**D** **CRANSTON BUFFET LAMP**  
STUDIO VC

**S3407**  
H: 34.75" | W: 8.5" | Base: 7.5" x 4" Rec.  
Socket: E26 Keyless Nurdy | Bulb: 60 A  
Shade: 7" x 8.5" x 7.25"  
\* Line Switch

**D** **S3407BSL-NP**  
Burnished Silver Leaf | Natural Paper



**D** **S3407GI-NP**  
Gilded Iron | Natural Paper



**D** **S3407AI-NP**  
Aged Iron | Natural Paper

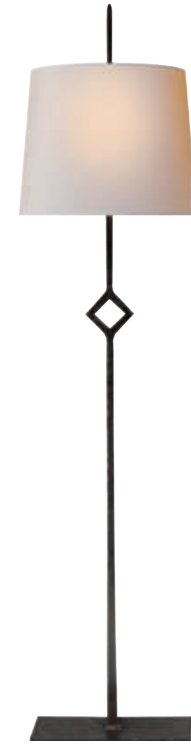

**A** **TOB3152AI-NP**  
Aged Iron | Natural Paper



**C** **S3401GI-NP**  
Gilded Iron | Natural Paper



**C** **S3401AI-NP**  
Aged Iron | Natural Paper



**E** **S3320PN-NP**  
Polished Nickel | Natural Paper



**E** **S3320GI-NP**  
Gilded Iron | Natural Paper



**E** **S3320AI-NP**  
Aged Iron | Natural Paper



**B** **DAUPHINE BEDSIDE LAMP**  
STUDIO VC

**S3400**  
H: 23.5" | W: 12" | Base: 5" x 8" Rec.  
Socket: E26 Hi-Lo | Bulb: 100 A  
Shade: 10" x 12" x 9.5"  
\* French Wired

**C** **DAUPHINE TABLE LAMP**  
STUDIO VC

**S3401**  
H: 31.5" | W: 16" | Base: 6" x 9.5" Rec.  
Socket: E26 Hi-Lo | Bulb: 150 A  
Shade: 13.5" x 16" x 12.5"  
\* French Wired

**E** **ETOILE LARGE TABLE LAMP**  
IAN K. FOWLER

**S3320**  
H: 36.5" | W: 9.75" | Base: 9" Cross  
Socket: E26 Dimmer | Bulb: 60 A  
Shade: 8.25" x 9.75" x 13"

**A BRISTOL TABLE LAMP**  
AERIN

**ARN3022**  
H: 31" | W: 10" | Base: 6.5" Round  
Socket: E26 Dimmer | Bulb: 60 A  
Shade: 8" x 10" x 9"

**A ARN3022BSL-L**  
Burnished Silver Leaf | Linen



**A ARN3022G-L**  
Gild | Linen



**A ARN3022AI-L**  
Aged Iron | Linen



**C ARN3144BSL-L**  
Burnished Silver Leaf | Linen



**C ARN3144G-L**  
Gild | Linen



**C ARN3144AI-L**  
Aged Iron | Linen



**C DOVER BUFFET LAMP**  
AERIN

**ARN3144**  
H: 31.25" | W: 10.25" | Base: 7" Round  
Socket: E26 Dimmer | Bulb: 60 A  
Shade: 8" x 10.25" x 9.25"

**B BEAUMONT MEDIUM BUFFET LAMP**  
AERIN

**ARN3301**  
H: 30" | W: 10" | Base: 7" Round  
Socket: E26 Dimmer | Bulb: 60 A  
Shade: 9" x 10" x 8.5"  
**Additional Options:**  
White | Linen (WHT-L)

**B ARN3301BSL-L**  
Burnished Silver Leaf | Linen



**B ARN3301G-L**  
Gild | Linen



**B ARN3301AI-L**  
Aged Iron | Linen



**D ARN3002BSL-L**  
Burnished Silver Leaf | Linen



**D ARN3002G-L**  
Gild | Linen



**D ARN3002AI-L**  
Aged Iron | Linen



**D DOVER TABLE LAMP**  
AERIN

**ARN3002**  
H: 34.75" | W: 18" | Base: 7" Round  
Socket: E26 Dimmer | Bulb: 150 A  
Shade: 13" x 18" x 13"



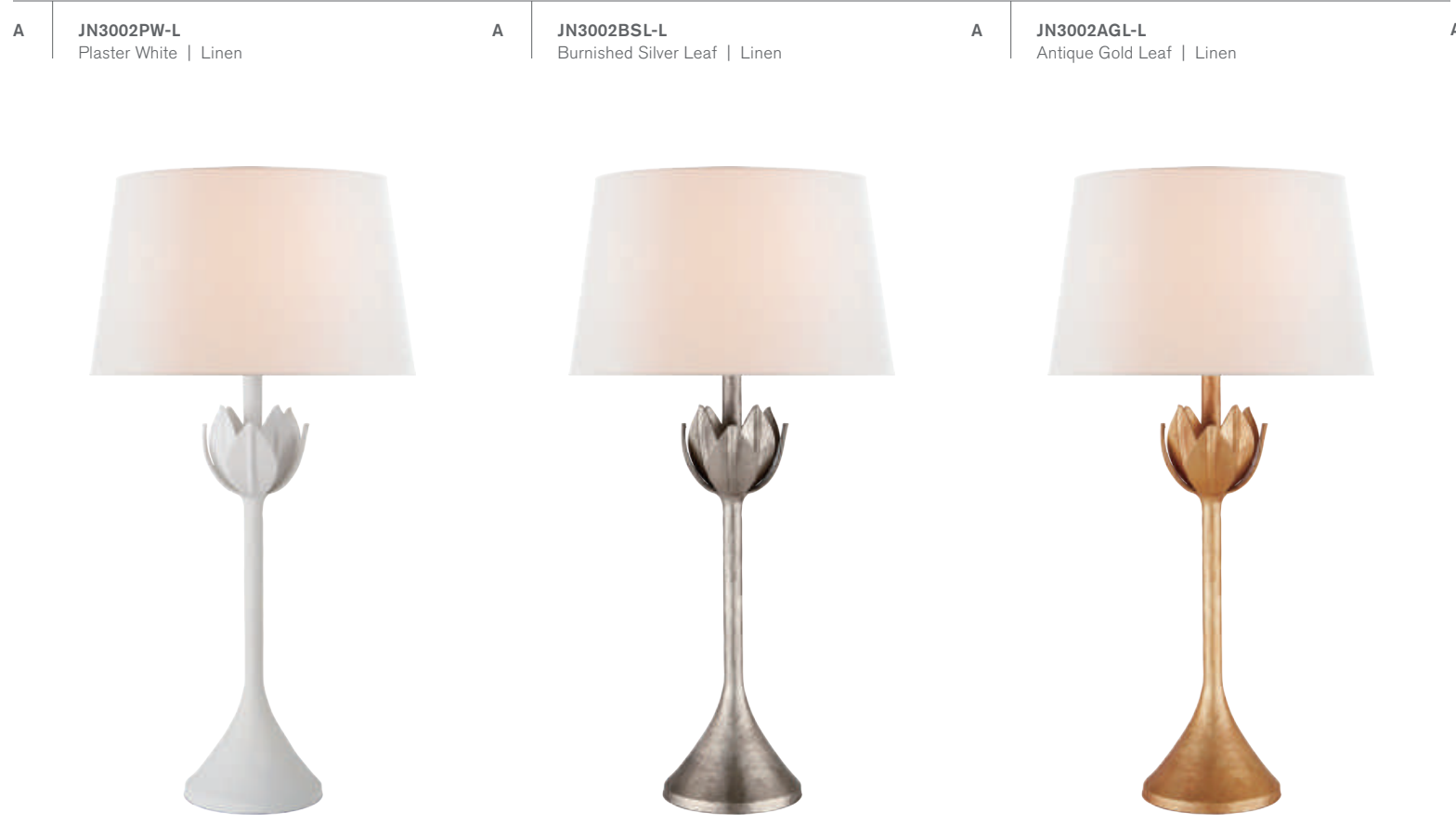

**A** **JN3002PW-L**  
Plaster White | Linen

**A** **JN3002BSL-L**  
Burnished Silver Leaf | Linen

**A** **JN3002AGL-L**  
Antique Gold Leaf | Linen

**A** **ALBERTO LARGE TABLE LAMP**  
JULIE NEILL

**JN3002**  
H: 32.25" | W: 17" | Base: 7.5" Round  
Socket: E26 Dimmer | Bulb: 100 A  
Shade: 14" x 17" x 10"

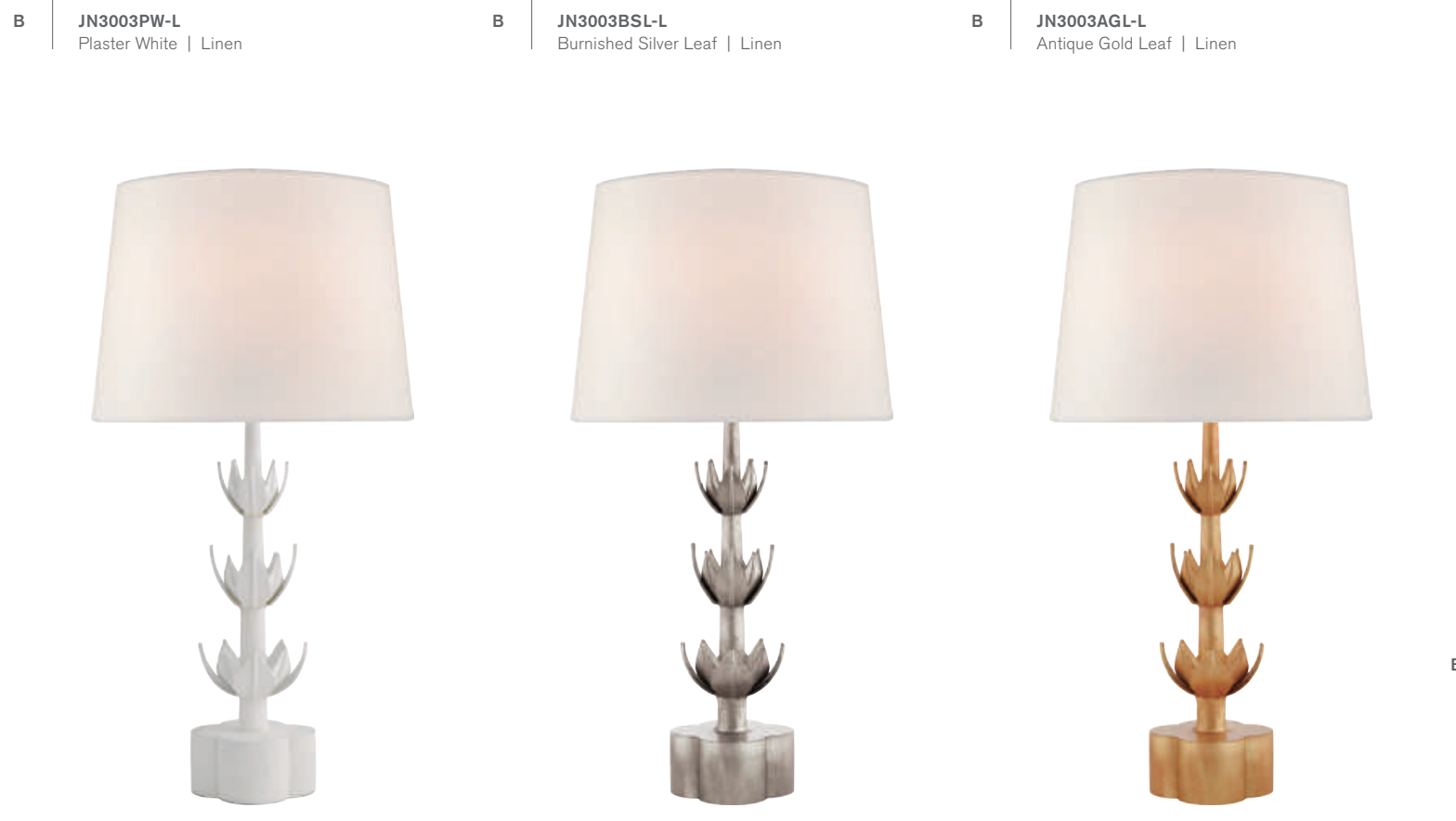

**B** **JN3003PW-L**  
Plaster White | Linen

**B** **JN3003BSL-L**  
Burnished Silver Leaf | Linen

**B** **JN3003AGL-L**  
Antique Gold Leaf | Linen

**B** **ALBERTO LARGE TRIPLE TABLE LAMP**  
JULIE NEILL

**JN3003**  
H: 31.75" | W: 16.5" | Base: 6.5" Decorative  
Socket: E26 Dimmer | Bulb: 100 A  
Shade: 14.5" x 16.5" x 12.5"



**C** **ARN3080PW-L**  
Plaster White | Linen

**C** **ARN3080G-L**  
Gild | Linen

**C** **FLIANA TABLE LAMP**  
AERIN

**ARN3080**  
H: 28" | W: 9" | Base: 8.5" Square  
Socket: E26 Dimmer | Bulb: 100 A  
Shade: 8" x 9" x 9"  
**Additional Options:**  
Aged Iron | Linen (AI-L)

**D** **LOTUS TABLE LAMP**  
BARBARA BARRY

**BBL3003**  
H: 33" | W: 17" | Base: 10" Round  
Socket: E26 Dimmer | Bulb: 150 A  
Shade: 16" x 17" x 14"

**D** **BBL3003WHT-S**  
Matte White | Silk

**D** **BBL3003G-S**  
Gild | Silk



**E** **MONTREUIL TRIPLE TABLE LAMP**  
AERIN

**ARN3052**  
H: 30" | W: 11.5" | Base: 8.25" Round  
Socket: 3 - E12 Candelabra | Bulb: 3 - 40 B  
Shade: 2.5" x 4.5" x 6.25"



**E** **ARN3052BSL-L**  
Burnished Silver Leaf | Linen



**E** **ARN3052G-L**  
Gild | Linen

**A** **TOB3734PW-NP**  
Plaster White | Natural Paper



**B** **TOB3735PW-NP**  
Plaster White | Natural Paper



**B** **TOB3735G-NP**  
Gild | Natural Paper



**C** **SK3012PW-L**  
Plaster White | Linen



**D** **SK3013PW-L**  
Plaster White | Linen



**C** **SK3012G-L**  
Gild | Linen



**D** **SK3013G-L**  
Gild | Linen

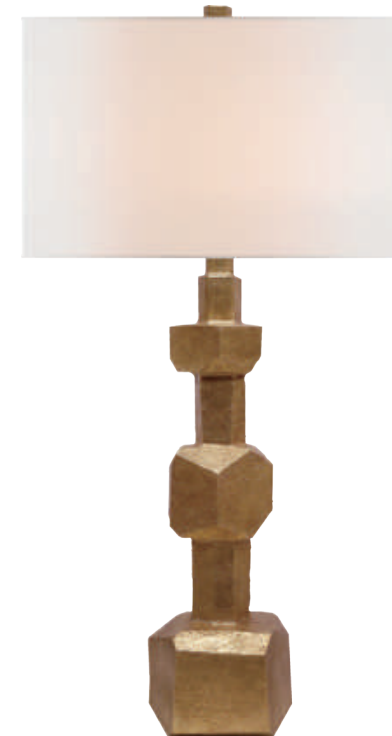

opposite page

**A** **SIERRA BEDSIDE LAMP**  
THOMAS O'BRIEN

**TOB3734**  
H: 19.25" | W: 14" | Base: 6" x 8.75" Decorative  
Socket: E26 Dimmer | Bulb: 75 A  
Shade: 12.25" x 14" x 9.5" Oval  
**Additional Options:**  
Burnished Silver Leaf | Natural Paper (BSL-NP)  
Gilded | Natural Paper (G-NP)

**B** **SIERRA TABLE LAMP**  
THOMAS O'BRIEN

**TOB3735**  
H: 27.75" | W: 17.5" | Base: 5" x 8" Decorative  
Socket: E26 Dimmer | Bulb: 100 A  
Shade: 15.75" x 17.5" x 11.5" Oval  
**Additional Options:**  
Burnished Silver Leaf | Natural Paper (BSL-NP)

**C** **VIENNE MEDIUM TABLE LAMP**  
SUZANNE KASLER

**SK3012**  
H: 26.75" | W: 18" | Base: 5" Sculptural  
Socket: E26 Dimmer | Bulb: 100 A  
Shade: 18" x 18" x 10.5" Oval

**D** **VIENNE MEDIUM BUFFET LAMP**  
SUZANNE KASLER

**SK3013**  
H: 33" | W: 18" | Base: 5" Sculptural  
Socket: E26 Dimmer | Bulb: 100 A  
Shade: 18" x 18" x 10.5" Oval

**E** **CANNES TABLE LAMP**  
AERIN

**ARN3100**  
H: 31" | W: 17" | Base: 8.25" Decorative  
Socket: E26 Dimmer | Bulb: 150 A  
Shade: 17" x 17" x 12.5"  
\* French Wired

**E** **ARN3100BSL-L**  
Burnished Silver Leaf | Linen

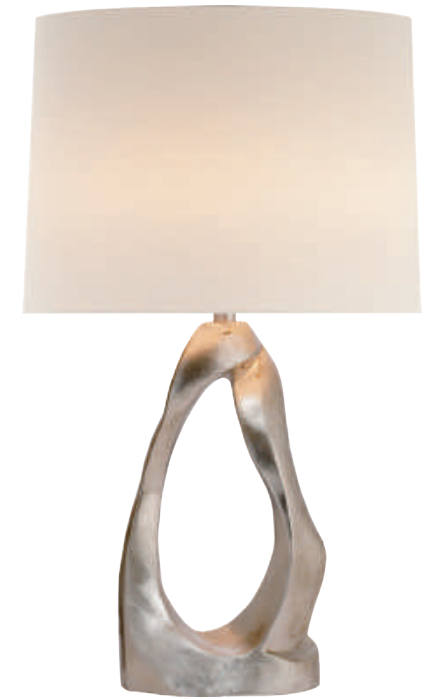

**E** **ARN3100G-L**  
Gild | Linen



**A** | **AH3040WHT-NP**  
Matte White | Natural Paper



**A** | **LUCILLE TABLE LAMP**  
ALEXA HAMPTON  
**AH3040**  
H: 31" | W: 18" | Base: 5" Round  
Socket: 2 - E26 Pull Chain | Bulb: 2 - 60 A  
Shade: 10" x 18" x 13"

**B** | **WARREN ACCENT TABLE LAMP**  
AERIN  
**ARN3600**  
H: 13.25" | W: 7" | Base: 2.5" Round  
Socket: E26 Dimmer | Bulb: 60 A  
Shade: 6.25" x 7" x 7.25"

**C** | **WARREN TABLE LAMP**  
AERIN  
**ARN3601**  
H: 32.5" | W: 17" | Base: 4.25" Round  
Socket: E26 Dimmer | Bulb: 150 A  
Shade: 15" x 17" x 17.5"

**B** | **ARN3600BSL-L**  
Burnished Silver Leaf | Linen



**B** | **ARN3600G-L**  
Gild | Linen



**B** | **ARN3601G-L**  
Gild | Linen



**A** | **AH3040G-NP**  
Gilded | Natural Paper



**C** | **ARN3601BSL-L**  
Burnished Silver Leaf | Linen



**C** | **ARN3601G-L**  
Gild | Linen



**D** | **ARN3320PW-L**  
Plaster White | Linen



**D** | **ARN3320G-L**  
Gild | Linen



opposite page

**D** | **LIVIA SMALL TABLE LAMP**  
AERIN  
**ARN3320**  
H: 24.5" | W: 9" | Base: 7.25" Round  
Socket: E26 Keyless | Bulb: 60 A  
Shade: 8.5" x 9" x 16.5"  
**Additional Options:**  
Burnished Silver Leaf | Linen (BSL-L)

**A** | **CHA8530GI-NP**  
Gilded Iron | Natural Paper



**A** | **CHA8530AI-NP**  
Aged Iron | Natural Paper



**A** | **CHA8530GI-NP**  
Gilded Iron | Natural Paper



**B** | **S3514GI-PL**  
Gilded Iron | Percale



**C** | **S3513GI-PL**  
Gilded Iron | Percale



**B** | **S3514AI-PL**  
Aged Iron | Percale



**C** | **S3513AI-PL**  
Aged Iron | Percale



opposite page

**A** | **METAL BANDED TABLE LAMP**  
E. F. CHAPMAN

**CHA8530**  
H: 29" | W: 19" | Base: 7.5" Hexagon  
Socket: E26 Dimmer | Bulb: 150 A  
Shade: 15" x 19" x 12"  
\* French Wired  
©EFC DESIGNS

**D** | **S3051GI-NP**  
Gilded Iron | Natural Paper



**D** | **S3051BR-NP**  
Black Rust | Natural Paper



**B** | **SCALA BEDSIDE LAMP**  
IAN K. FOWLER

**S3514**  
H: 17.75" | W: 16.25" | Ext: 7.75"  
Socket: 2 - E12 Keyless | Bulb: 2 - 40 B  
Shade: 15.5" x 16.5" x 7.5" Rec.  
\* Line Switch

**C** | **SCALA TABLE LAMP**  
IAN K. FOWLER

**S3513**  
H: 26.25" | W: 16" | Base: 6.5" Cross  
Socket: E26 Dimmer | Bulb: 75 A  
Shade: 16" x 16" x 8.75"

**D** | **ASPEN TABLE LAMP**  
IAN K. FOWLER

**S3051**  
H: 22.5" | W: 16" | Base: 4.5" x 9" Rec.  
Socket: 2 - E12 Candelabra | Bulb: 2 - 60 B  
Shade: 15" x 16" x 8" Rec.  
\* Line Switch

**A** SK3549GI-L  
Gilded Iron | Linen



**A** SK3549AI-L  
Aged Iron | Linen



**A** QUATREFOIL ACCENT LAMP  
SUZANNE KASLER  
  
SK3549  
H: 18.5" | W: 10" | Base: 5" Square  
Socket: E12 Candelabra | Bulb: 60 B  
Shade: 10" x 10" x 7.25"  
\* Line Switch

**B** QUATREFOIL TABLE LAMP  
SUZANNE KASLER  
  
SK3500  
H: 35.5" | W: 18" | Base: 9.5" Square  
Socket: E26 Dimmer | Bulb: 150 A  
Shade: 17.5" x 18" x 13"

**C** SK3100GI-NP  
Gilded Iron | Natural Paper



**B** SK3500GI-L  
Gilded Iron | Linen



**B** SK3500AI-L  
Aged Iron | Linen



**B** SK3500BW-L  
Belgian White | Linen



**C** HARPER TABLE LAMP  
SUZANNE KASLER  
  
SK3100  
H: 29.5" | W: 15.5" | Base: 3.5" x 12.5" Rec.  
Socket: E26 Dimmer | Bulb: 150 A  
Shade: 12.5" x 15.5" x 9.5"

**C** SK3100NR-NP  
Natural Rust | Natural Paper



**C** SK3100NR-NP  
Natural Rust | Natural Paper



**A** **S3715GI-L**  
Gilded Iron | Linen



**A** **S3715AI-L**  
Aged Iron | Linen



**B** **TOB3026GI-NP**  
Gilded Iron | Natural Paper



**C** **CHA8994GI-NP**  
Gilded Iron | Natural Paper



**C** **CHA8994AI-NP**  
Aged Iron | Natural Paper



opposite page

**A** **ANNEU TABLE LAMP**  
STUDIO VC

**S3715**  
H: 28.75" | W: 16" | Base: 9" Round  
Socket: E26 Dimmer | Bulb: 75 A  
Shade: 11.5" x 16" x 12"  
\* French Wired

**B** **NINA TAPERED TABLE LAMP**  
THOMAS O'BRIEN

**TOB3026**  
H: 31" | W: 15" | Base: 12" Round  
Socket: E26 Hi-Lo | Bulb: 150 A  
Shade: 14" x 15" x 9.5"  
**Additional Options:**  
Aged Iron | Natural Paper (AI-NP)

**C** **RUSSELL MODERN TRIPOD TABLE LAMP**  
E. F. CHAPMAN

**CHA8994**  
H: 28.5" | W: 19" | Base: 10" Tripod  
Socket: E26 Dimmer | Bulb: 150 A  
Shade: 15.5" x 19" x 10.5"  
©EFC DESIGNS

**D** **UTOPIA TABLE LAMP**  
KELLY WEARSTLER

**KW3055**  
H: 27.75" | W: 15" | Base: 4.75" Round  
Socket: E26 Dimmer | Bulb: 100 A  
Shade: 8" x 15" x 11.75"

**E** **CACHET TABLE LAMP**  
KELLY WEARSTLER

**KW3135**  
H: 28" | W: 17" | Base: 3.25" Round  
Socket: E26 Keyless | Bulb: 12 LED A  
Shade: 13" x 17" x 12"

**F** **TAVARES LARGE TABLE LAMP**  
THOMAS O'BRIEN

**TOB3390**  
H: 36" | W: 13.75" | Base: 13" Tripod  
Socket: E26 Dimmer | Bulb: 60 A  
Shade: 11.75" x 13.75" x 15"

**D** **KW3055AI-L**  
Aged Iron | Linen



**E** **KW3135AI-L**  
Aged Iron | Linen



**D** **KW3055G-L**  
Gild | Linen



**F** **TOB3390AI/HAB-L**  
Aged Iron | Hand-Rubbed Antique Brass | Linen



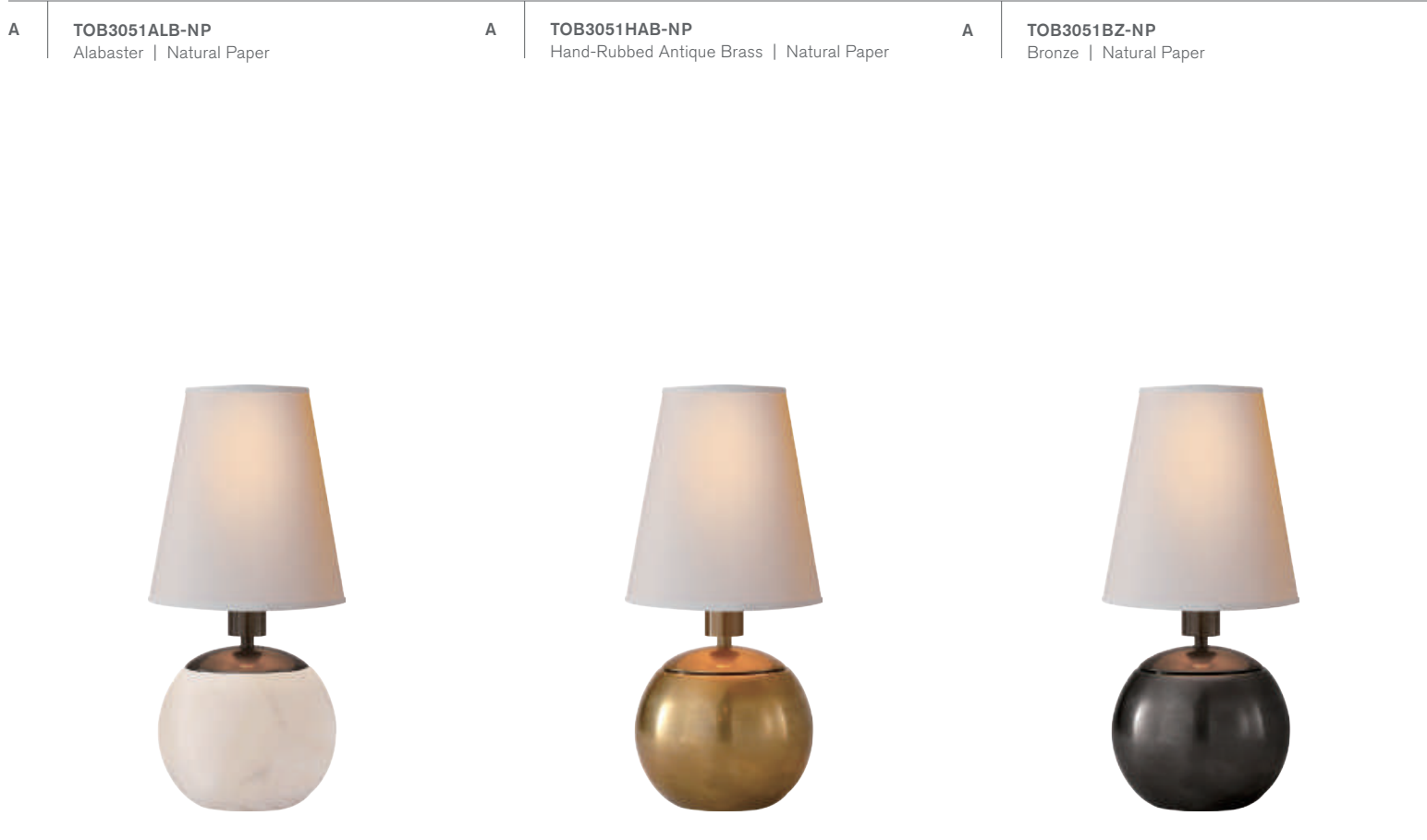

**A** **TERRI SMALL ROUND ACCENT LAMP**  
THOMAS O'BRIEN

**TOB3051**  
H: 10.25" | W: 5" | Base: 2.25" Round  
Socket: E12 Candelabra | Bulb: 40 B  
Shade: 3" x 5" x 5.5"  
\* French Wired/Line Switch

**B** **KENTON DESK LAMP**  
THOMAS O'BRIEN

**TOB3180**  
H: 16" | W: 12" | Base: 8" Square  
Socket: 2 - E26 Keyless | Bulb: 2 - 40 A  
Shade: 13" x 13" x 6"  
\* Switch on Base

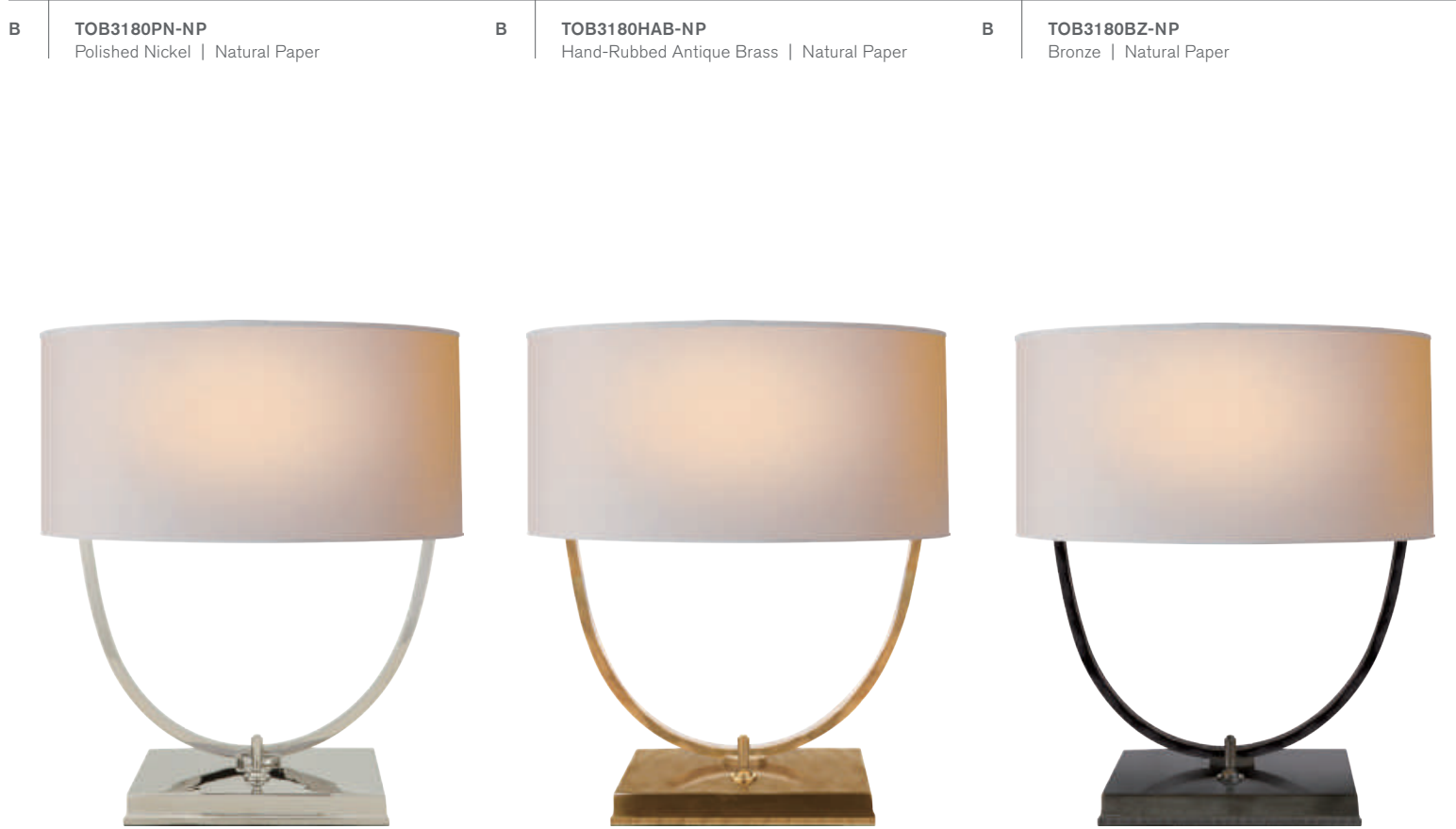

opposite page

**C** **SIMONE MEDIUM TABLE LAMP**  
THOMAS O'BRIEN

**TOB3630**  
H: 27.5" | W: 15" | Base: 5.5" Rec.  
Socket: E26 Dimmer | Bulb: 75 A  
Shade: 13" x 15" x 10.75" Rec.

**D** **SIMONE MEDIUM BUFFET LAMP**  
THOMAS O'BRIEN

**TOB3631**  
H: 33" | W: 12.75" | Base: 5.5" Rec.  
Socket: E26 Dimmer | Bulb: 60 A  
Shade: 11" x 12.75" x 10" Rec.

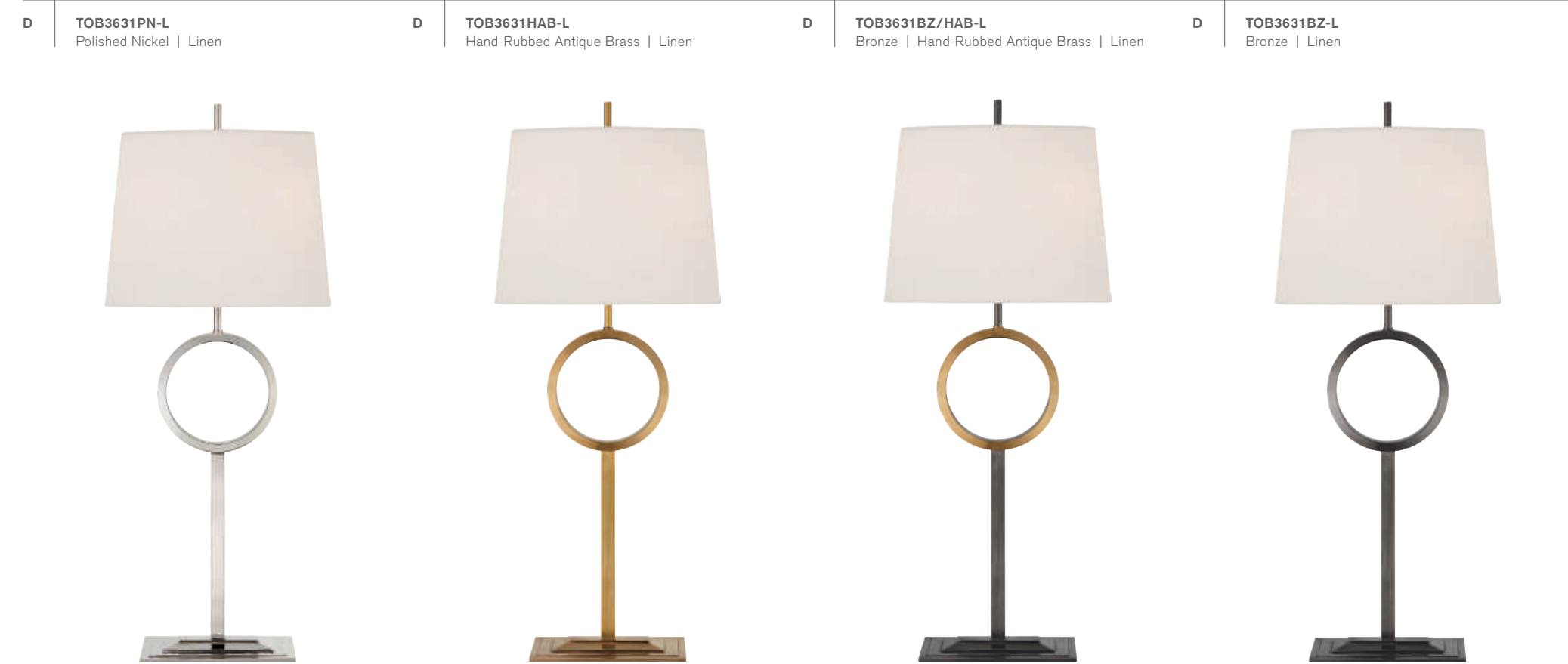
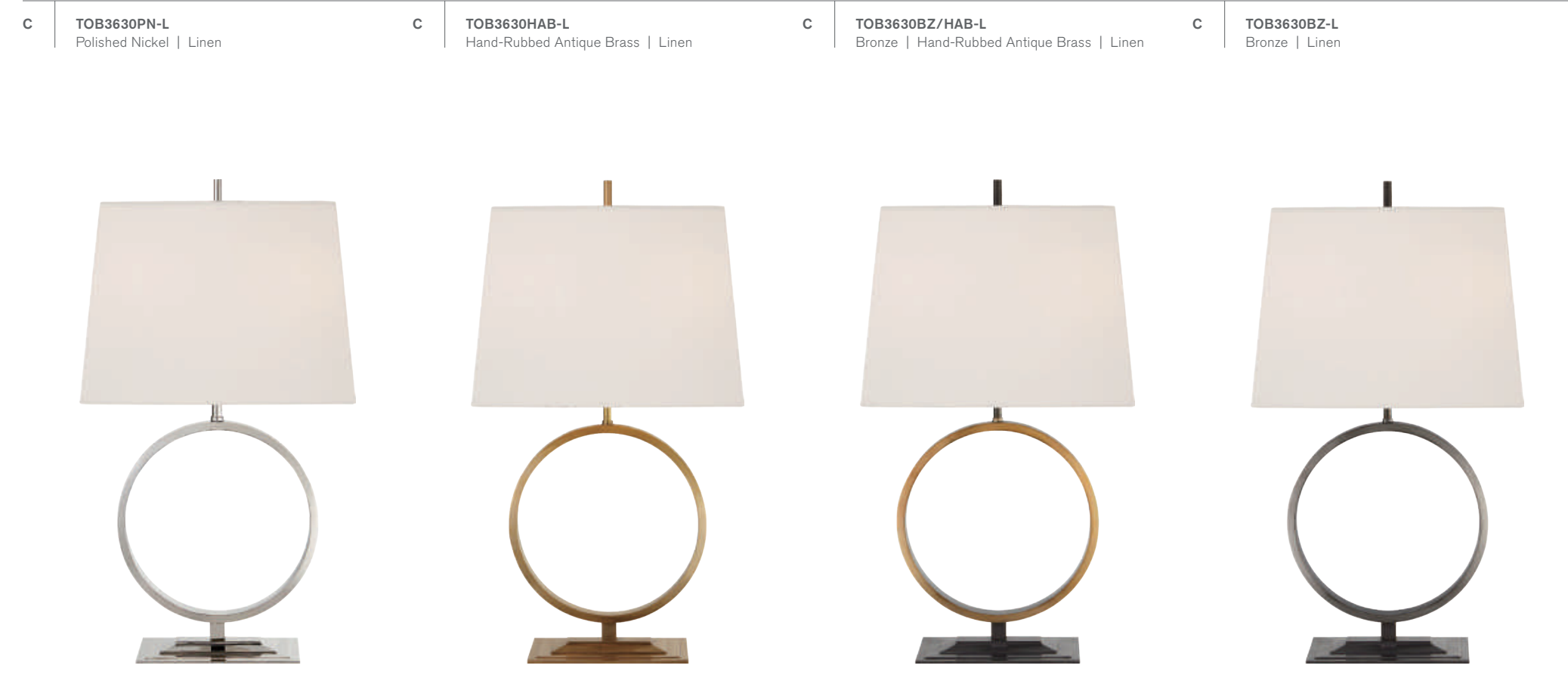

**A** | **CHA8969PN-NP**  
Polished Nickel | Natural Paper



**A** | **CHA8969G-NP**  
Gild | Natural Paper



**A** | **CHA8969BZ-NP**  
Bronze | Natural Paper



**A** | **RING FORM SMALL TABLE LAMP**  
E. F. CHAPMAN  
**CHA8969**  
H: 21" | W: 13.5" | Base: 4" x 5.5" Rec.  
Socket: E26 Hi-Lo | Bulb: 75 A  
Shade: 10.5" x 13.5" x 8.5" Rec.  
**Additional Options:**  
Antique-Burnished Brass | Natural Paper (AB-NP)  
©EFC DESIGNS

**B** | **CHA8970PN-NP**  
Polished Nickel | Natural Paper



**B** | **CHA8970G-NP**  
Gilded | Natural Paper



**B** | **CHA8970BZ-NP**  
Bronze | Natural Paper



**B** | **RING FORM LARGE TABLE LAMP**  
E. F. CHAPMAN  
**CHA8970**  
H: 27" | W: 18" | Base: 4.5" x 7.5" Rec.  
Socket: E26 Dimmer | Bulb: 100 A  
Shade: 14" x 18" x 11" Rec.  
©EFC DESIGNS

**B** | **CHA8970AB-NP**  
Antique-Burnished Brass | Natural Paper





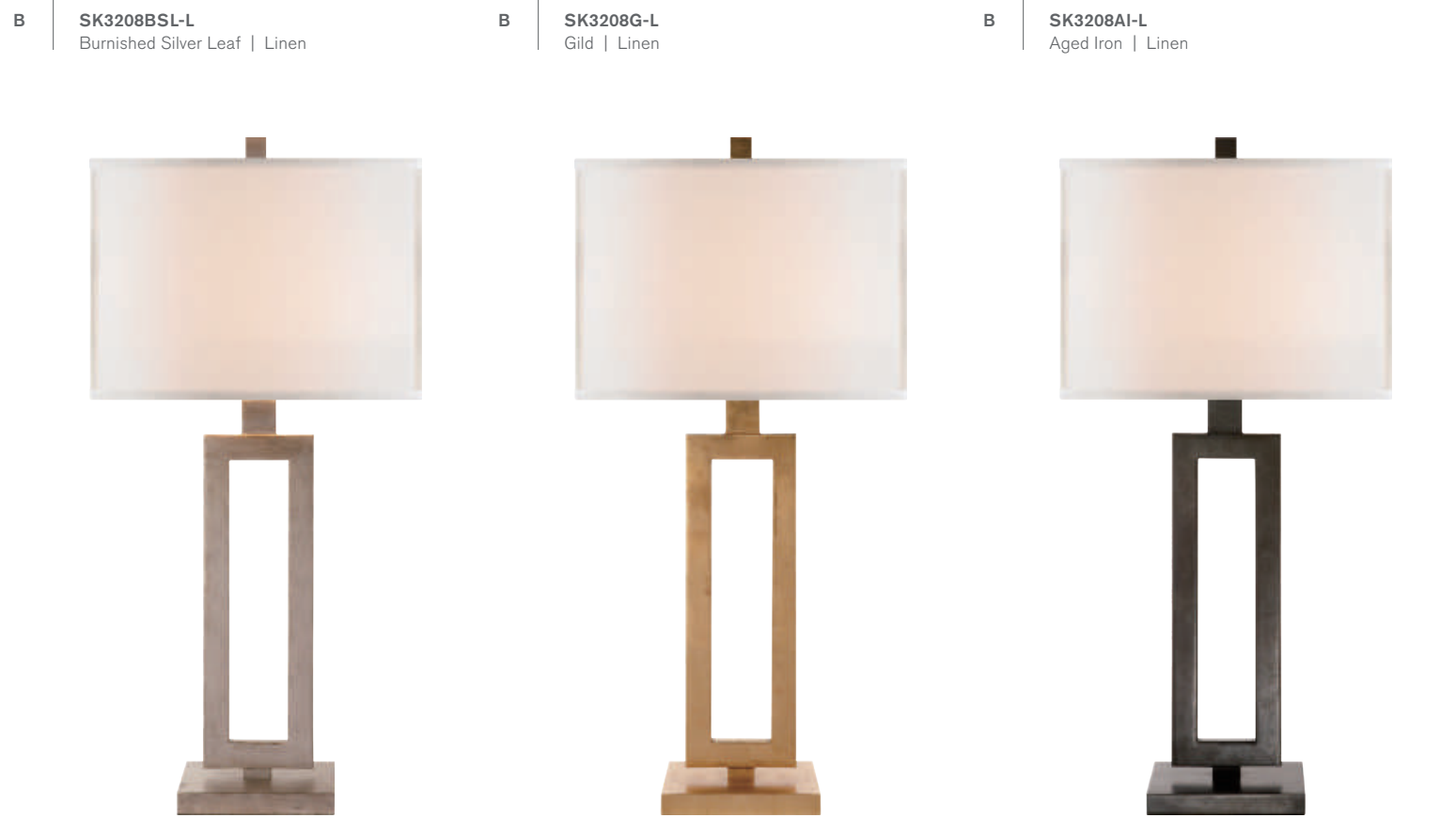
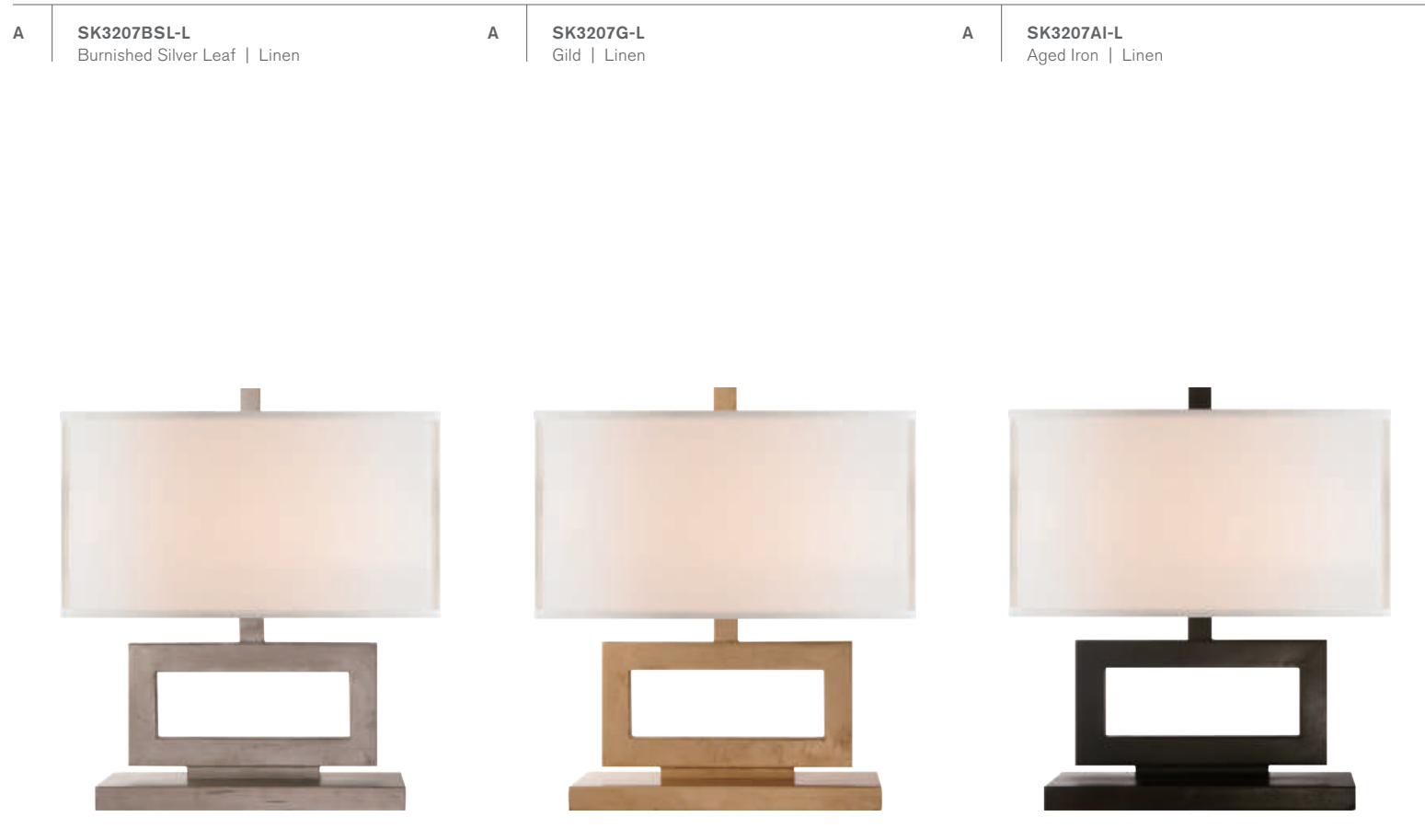

**A SK3207BLS-L**  
Burnished Silver Leaf | Linen

**A SK3207G-L**  
Gild | Linen

**A SK3207AI-L**  
Aged Iron | Linen

**A MOD LOW TABLE LAMP**  
SUZANNE KASLER

**SK3207**  
H: 16" | W: 15" | Base: 4" x 12" Rec.  
Socket: E26 Hi-Lo | Bulb: 60 A  
Shade: 15" x 15" x 8" Rec.

**B MOD TALL TABLE LAMP**  
SUZANNE KASLER

**SK3208**  
H: 28" | W: 14" | Base: 5.5" x 7" Rec.  
Socket: E26 Hi-Lo | Bulb: 150 A  
Shade: 14" x 14" x 10" Rec.

**B SK3208BLS-L**  
Burnished Silver Leaf | Linen

**B SK3208G-L**  
Gild | Linen

**B SK3208AI-L**  
Aged Iron | Linen

**C CAROUSEL TABLE LAMP**  
BARBARA BARRY

**BBL3008**  
H: 31" | W: 17" | Base: 7" Round  
Socket: E26 Dimmer | Bulb: 150 A  
Shade: 16" x 17" x 13"  
**Additional Options:**  
Bronze | Silk (BZ-S)

**D MARGOT MEDIUM TRIPLE ARM TABLE LAMP**  
SUZANNE KASLER

**SK3030**  
H: 24" | W: 15" | Base: 7.75" x 9.25" Rec.  
Socket: 3 - E26 In-Line Switch | Bulb: 3 - 40 A  
Shade: 5.25" x 6.5" x 6.75"

opposite page



**C BBL3008SS-S**  
Soft Silver | Silk



**D SK3030PN-L**  
Polished Nickel | Linen

**D SK3030HAB-L**  
Hand-Rubbed Antique Brass | Linen



A | **BBL3070BZ-S**  
Bronze | Silk



A | **BBL3070SS-S**  
Soft Silver | Silk



A | **BBL3070SB-S**  
Soft Brass | Silk



A | **BBL3070BZ-S**  
Bronze | Silk



A | **SWING TABLE LAMP**  
BARBARA BARRY

**BBL3070**  
H: 22" | W: 11" | Ext: 13.25"  
Base: 8" Round | Socket: E26 Keyless  
Shade: 10.25" x 11" x 10"  
\* Line Switch

B | **BBL3110SS-S**  
Soft Silver | Silk



B | **BBL3110SB-S**  
Soft Brass | Silk



B | **BBL3110BZ-S**  
Bronze | Silk



B | **FRAMEWORK DESK LAMP**  
BARBARA BARRY

**BBL3110**  
H: 17.5" | W: 10.5" | Base: 10.5" Round  
Socket: E26 Keyless | Bulb: 75 A  
Shade: 9.75" x 9.75" x 7.5"  
\* Line Switch

- A TOB3032HAB/BZ-NP**  
Brass | Bronze | Natural Paper
- A TOB3032PAR-NP**  
Parchment Leather | Natural Paper
- A TOB3032ESP-NP**  
Espresso Leather | Natural Paper



**A DIXON SMALL TABLE LAMP**  
THOMAS O'BRIEN

**TOB3032**  
H: 21" | W: 13.25" | Base: 4.5" x 6.75" Rec.  
Socket: 2 - E26 Pull Chain | Bulb: 2 - 60 A  
Shade: 8.5" x 13.25" x 9" Rec.  
**Additional Options:**  
Hand-Rubbed Antique Brass | Bronze (HAB/BZ-BZ)

**B DIXON TALL TABLE LAMP**  
THOMAS O'BRIEN

**TOB3033**  
H: 30.5" | W: 18" | Base: 7.75" x 9.5" Rec.  
Socket: 2 - E26 Pull Chain | Bulb: 2 - 60 A  
Shade: 13.5" x 18" x 11.5" Rec.  
**Additional Options:**  
Brass | Bronze | Natural Paper (HAB/BZ-NP)

- B TOB3033HAB/BZ-BZ**  
Hand-Rubbed Antique Brass | Bronze
- B TOB3033PAR-NP**  
Parchment Leather | Natural Paper
- B TOB3033ESP-NP**  
Espresso Leather | Natural Paper



opposite page

**C CONVECTOR RECTANGULAR TABLE LAMP**  
E. F. CHAPMAN

**CHA8539**  
H: 27" | W: 16.5" | Base: 4.75" x 9.5" Rec.  
Socket: E26 Hi-Lo | Bulb: 150 A  
Shade: 15" x 16.5" x 10" Rec.  
©EFC DESIGNS

**D PHILOSOPHY DESK LAMP**  
BARBARA BARRY

**BBL3030**  
H: 17.5" | W: 15" | Base: 5.5" x 11" Rec.  
Socket: 2 - E26 Pull Chain | Bulb: 2 - 60 B  
Shade: 14.5" x 15" x 8.5" Rec.

- C CHA8539AZ-NP**  
Antique Zinc | Natural Paper



- D BBL3030PWT-S**  
Pewter | Silk



- D BBL3030BZ-S**  
Bronze | Silk



**A** **BBL3036CW-L**  
China White | Linen



**A** **BBL3036EBO-L**  
Ebony | Linen



**B** **BBL3024BZ-S**  
Bronze | Bronze Mirror Base | Silk



opposite page

**A** **REFINED RIB MEDIUM TABLE LAMP**  
BARBARA BARRY

**BBL3036**  
H: 28.25" | W: 13.5" | Base: 6" Round  
Socket: E26 Dimmer | Bulb: 100 A  
Shade: 13" x 13.5" x 12"

**B** **BBL3024SS-S**  
Soft Silver | Smoke Mirror Base | Silk



**B** **BBL3024SB-S**  
Soft Brass | Bronze Mirror Base | Silk



**B** **BBL3024BZ-S**  
Bronze | Bronze Mirror Base | Silk



**C** **BBL3035PWT-L**  
Pewter | Linen



**C** **BBL3035SB-L**  
Soft Brass | Linen



**C** **BBL3035BZ-L**  
Bronze | Linen



**B** **PETAL DESK LAMP**  
BARBARA BARRY

**BBL3024**  
H: 25.5" | W: 12.5" | Base: 5.5" Square  
Socket: E26 Dimmer | Bulb: 150 A  
Shade: 11.5" x 12.5" x 10.5"

**C** **LYRIC BRANCH TABLE LAMP**  
BARBARA BARRY

**BBL3035**  
H: 31.5" | W: 16.5" | Base: 5" x 9.25" Rec.  
Socket: E26 Dimmer | Bulb: 100 A  
Shade: 16.5" x 16.5" x 12.5" Rec.

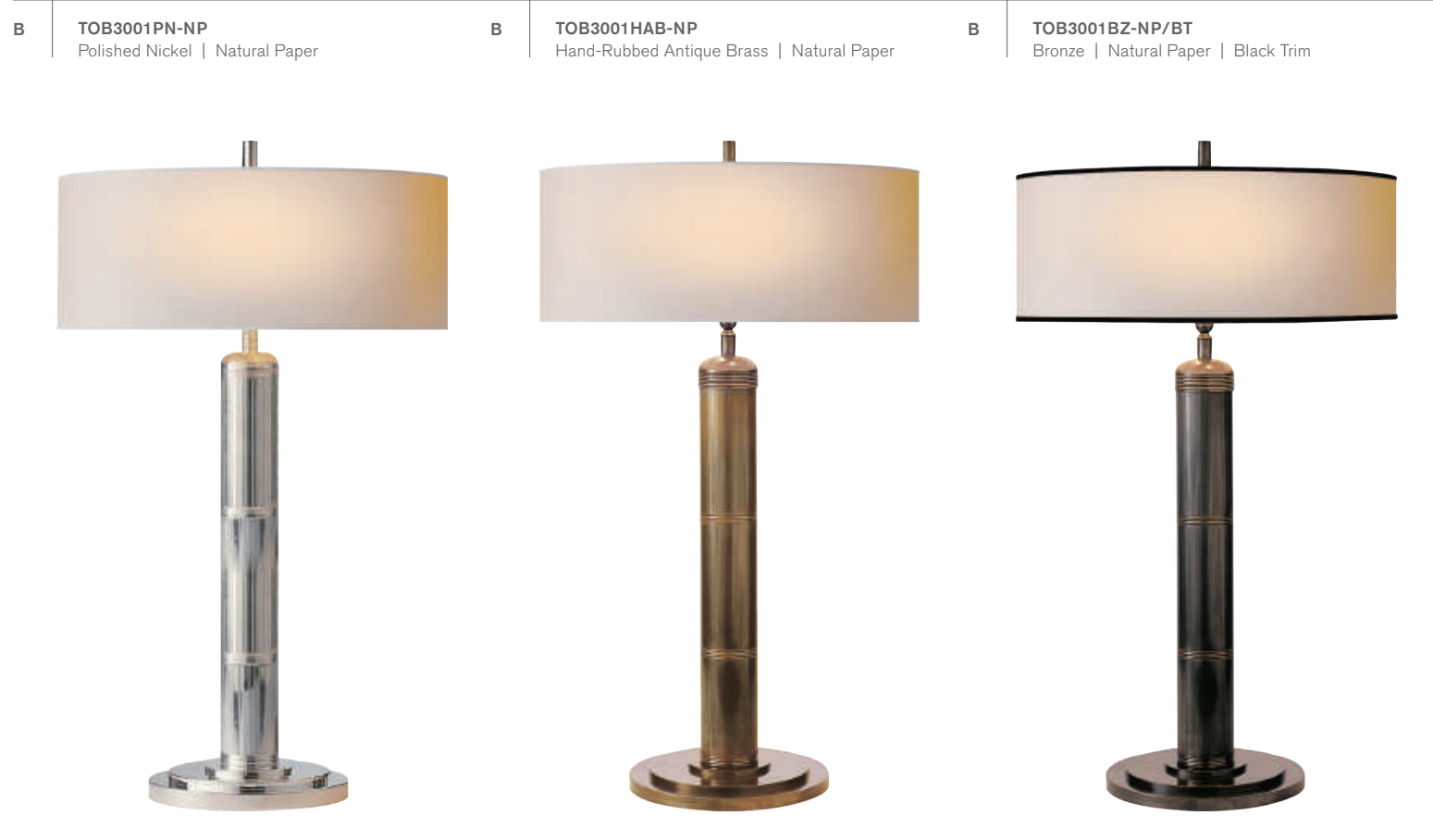
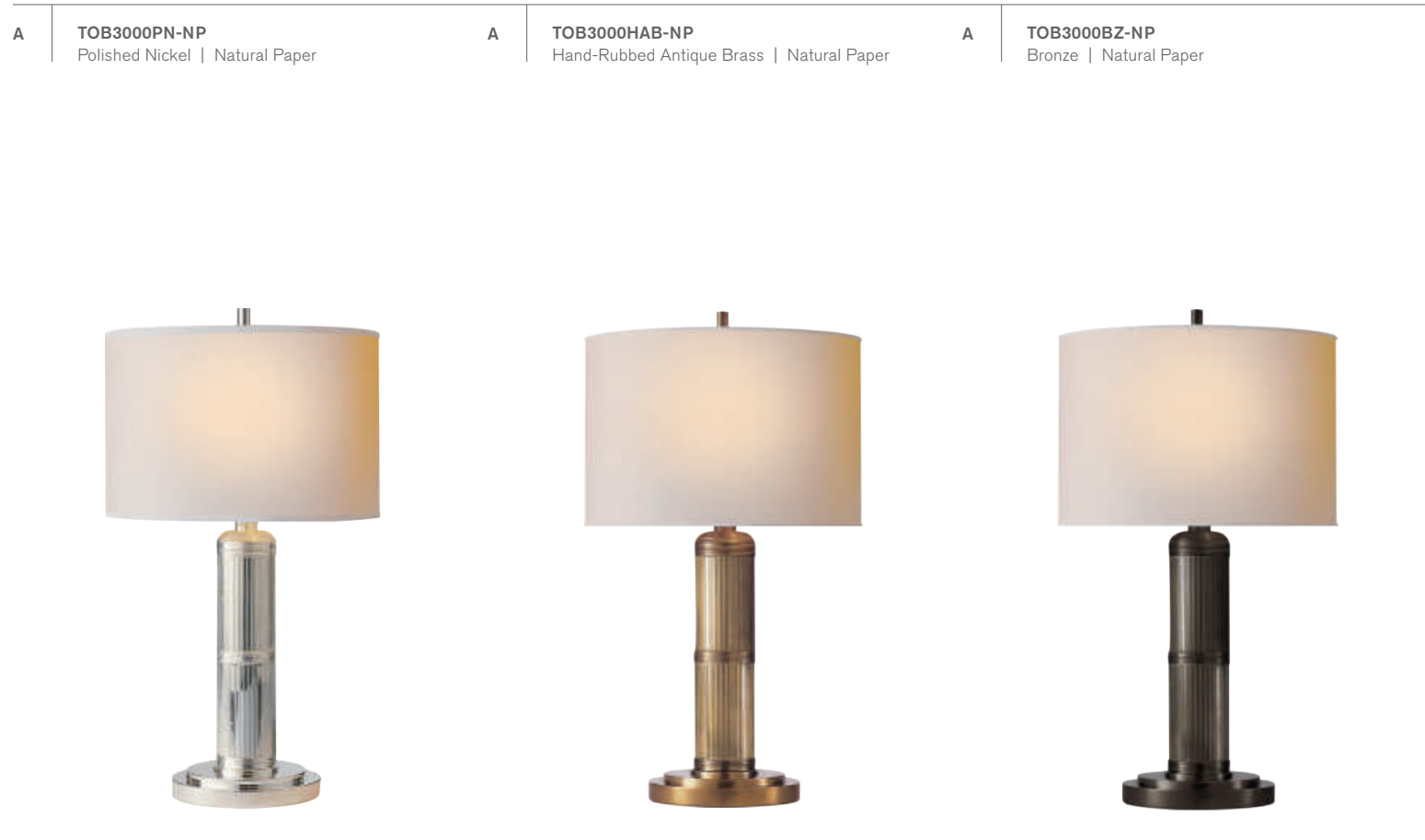

**A LONGACRE SMALL TABLE LAMP**  
THOMAS O'BRIEN  
**TOB3000**  
H: 16" | W: 9" | Base: 5" Round  
Socket: 2 - E26 Pull Chain | Bulb: 2 - 25 B  
Shade: 9" x 9" x 6"

**B LONGACRE TALL TABLE LAMP**  
THOMAS O'BRIEN  
**TOB3001**  
H: 32.5" | W: 20" | Base: 10.25" Round  
Socket: 2 - E26 Pull Chain | Bulb: 2 - 60 B  
Shade: 20" x 20" x 7.5"

opposite page  
**C CARON TABLE LAMP**  
THOMAS O'BRIEN  
**TOB3194**  
H: 26.5" | W: 16" | Base: 10" Tripod  
Socket: 2 - E26 Pull Chain | Bulb: 2 - 60 A  
Shade: 16" x 16" x 8"



**C TOB3194BZ/HAB-NP**  
Bronze | Brass | Natural Paper

**C TOB3194PN-NP**  
Polished Nickel | Natural Paper

**C TOB3194HAB-NP**  
Hand-Rubbed Antique Brass | Natural Paper

**A TOB3736PN/WM-L**  
Polished Nickel | White Marble | Linen



**A TOB3736HAB/WM-L**  
Hand-Rubbed Antique Brass | White Marble | Linen



**B TOB3737PN/WM-L**  
Polished Nickel | White Marble | Linen



**B TOB3737HAB/WM-L**  
Hand-Rubbed Antique Brass | White Marble | Linen



**A STEFANO MEDIUM TABLE LAMP**  
THOMAS O'BRIEN  
**TOB3736**  
H: 24.25" | W: 17" | Base: 6.5" Round  
Socket: 2 - E26 Pull Chain | Bulb: 2 - 40 A  
Shade: 17" x 17" x 7"

**B STEFANO LARGE TABLE LAMP**  
THOMAS O'BRIEN  
**TOB3737**  
H: 30.75" | W: 21" | Base: 8" Round  
Socket: 3 - E26 Pull Chain | Bulb: 3 - 40 A  
Shade: 21" x 21" x 7.5"

**C BRETT TABLE LAMP**  
THOMAS O'BRIEN  
**TOB3101**  
H: 25.75" - 32.75" | W: 9" | Base: 4.75" Square  
Socket: E26 On-Off | Bulb: 60 A  
Shade: 6.5" x 9" x 9.75"  
**Additional Options:**  
Black Marble | Bronze | Natural Paper (BM/BZ-NP)

**C TOB3101WM/PN-NP**  
White Marble | Nickel | Natural Paper



**C TOB3101WM/HAB-NP**  
White Marble | Brass | Natural Paper



opposite page

**D BANKS TABLE LAMP**  
THOMAS O'BRIEN  
**TOB3613**  
H: 27" | W: 9" | Base: 6.25" Round  
Socket: E26 Keyless | Bulb: 60 A  
Shade: 6.5" x 9" x 9.75"  
**Additional Options:**  
Polished Nickel | Natural Paper (PN-NP)  
\* Line Switch

**E DUFFY MEDIUM BUFFET LAMP**  
THOMAS O'BRIEN  
**TOB3106**  
H: 33.5" | W: 8.5" | Base: 6" Oct.  
Socket: E26 Keyless | Bulb: 60 A  
Shade: 5.5" x 8.5" x 9"  
**Additional Options:**  
Hand-Rubbed Antique Brass | Natural Paper (HAB-NP)

**F VIVIER BUFFET LAMP**  
THOMAS O'BRIEN  
**TOB3504**  
H: 32.25" | W: 9.25" | Base: 8" Round  
Socket: E26 Keyless | Bulb: 60 A  
Shade: 6.5" x 9" x 9.75"

**D TOB3613HAB/BZ-NP**  
Hand-Rubbed Antique Brass | Bronze | Natural Paper



**E TOB3106BZ/HAB-L**  
Bronze | Hand-Rubbed Antique Brass | Linen



**F TOB3504BK/HAB-L**  
Blackened Iron | Hand-Rubbed Antique Brass | Linen



**A** **S3177HAB-PL**  
Hand-Rubbed Antique Brass | Natural Percalé



**A** **S3177BZ-PL**  
Bronze | Natural Percalé



**A** **GRENOL BUFFET LAMP**  
STUDIO VC  
  
**S3177**  
H: 32.5" | W: 7.25" | Base: 6" Square  
Socket: E26 Dimmer | Bulb: 40 B  
Shade: 5.75" x 7.25" x 8"  
**Additional Options:**  
Polished Nickel | Natural Percalé (PN-PL)

**B** **HACKNEY TABLE LAMP**  
J. RANDALL POWERS  
  
**SP3022**  
H: 23" | W: 11.75" | Base: 6" Round  
Socket: E26 Keyless | Bulb: 40 B  
Shade: 3" x 11.75" x 7"  
**Additional Options:**  
Bronze | Natural Paper (BZ-NP)  
\* Line Switch

**C** **HACKNEY BUFFET LAMP**  
J. RANDALL POWERS  
  
**SP3023**  
H: 31.75" | W: 11.75" | Base: 6" Round  
Socket: E26 In-Line Switch | Bulb: 40 B  
Shade: 3" x 11.75" x 7"  
**Additional Options:**  
Hand-Rubbed Antique Brass | Natural Paper (HAB-NP)

opposite page  
**D** **HARGETT BUFFET LAMP**  
J. RANDALL POWERS

**SP3011**  
H: 21.5" - 29" | W: 11.75" | Base: 6" Round  
Socket: E26 Keyless Nordy | Bulb: 40 B  
Shade: 2" x 11.75" x 6.5"  
\* Line-Switch

**B** **SP3022PN-NP**  
Polished Nickel | Natural Paper



**C** **SP3023PN-NP**  
Polished Nickel | Natural Paper

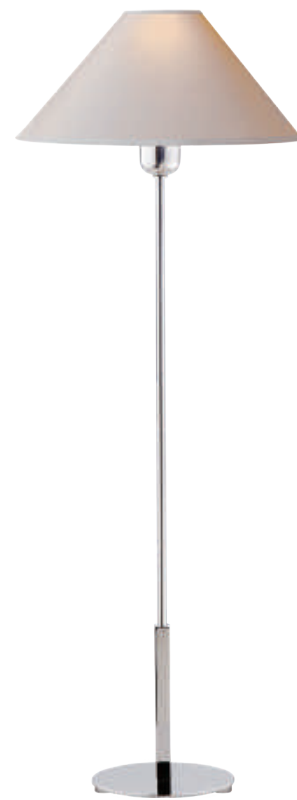

**B** **SP3022HAB-NP**  
Hand-Rubbed Antique Brass | Natural Paper



**C** **SP3023BZ-NP**  
Bronze | Natural Paper



**D** **SP3011HAB-NP**  
Hand-Rubbed Antique Brass | Natural Paper

**D** **SP3011PN-NP**  
Polished Nickel | Natural Paper



**D** **SP3011BZ-NP**  
Bronze | Natural Paper



**A BRYANT LARGE TABLE LAMP**  
THOMAS O'BRIEN

**TOB3260**  
H: 27.5" - 31.5" | W: 12" | Base: 8" Round  
Socket: E26 Dimmer | Bulb: 60 A  
Shade: 11" x 12" x 12"

<b>A TOB3260PN-NP</b> Polished Nickel   Natural Paper	<b>A TOB3260AN-NP</b> Antique Nickel   Natural Paper	<b>A TOB3260HAB-NP</b> Hand-Rubbed Antique Brass   Natural Paper	<b>A TOB3260BZ-NP</b> Bronze   Natural Paper
--	---	---	---



**B BRYANT TABLE LAMP**  
THOMAS O'BRIEN

**TOB3007**  
H: 24.5" - 30" | W: 6" | Base: 4.25" Round  
Socket: E26 Keyless | Bulb: 60 A  
Shade: 4" x 6" x 6.25"  
\* Line Switch

<b>B TOB3007PN-NP</b> Polished Nickel   Natural Paper	<b>B TOB3007AS-NP</b> Antique Silver   Natural Paper	<b>B TOB3007HAB-NP</b> Hand-Rubbed Antique Brass   Natural Paper	<b>B TOB3007BZ-NP</b> Bronze   Natural Paper
--	---	---	---



**C SIMPLE SCALLOP TABLE LAMP**  
BARBARA BARRY

**BBL3023**  
H: 26" - 33.5" | W: 15" | Base: 8" Round  
Socket: E26 Dimmer | Bulb: 150 A  
Shade: 14" x 15" x 12"

<b>C BBL3023SS-S</b> Soft Silver   Silk	<b>C BBL3023SB-S</b> Soft Brass   Silk	<b>C BBL3023BZ-S</b> Bronze   Silk
--	---	---------------------------------------



**D SIMPLE ADJUSTABLE TABLE LAMP**  
BARBARA BARRY

**BBL3023**  
H: 26" - 33.5" | W: 15" | Base: 8" Round  
Socket: E26 Dimmer | Bulb: 150 A  
Shade: 14" x 15" x 12"

<b>D BBL3023SS-S2</b> Soft Silver   Silk Banded	<b>D BBL3023SB-S2</b> Soft Brass   Silk Banded	<b>D BBL3023BZ-S2</b> Bronze   Silk Banded
--	---	---





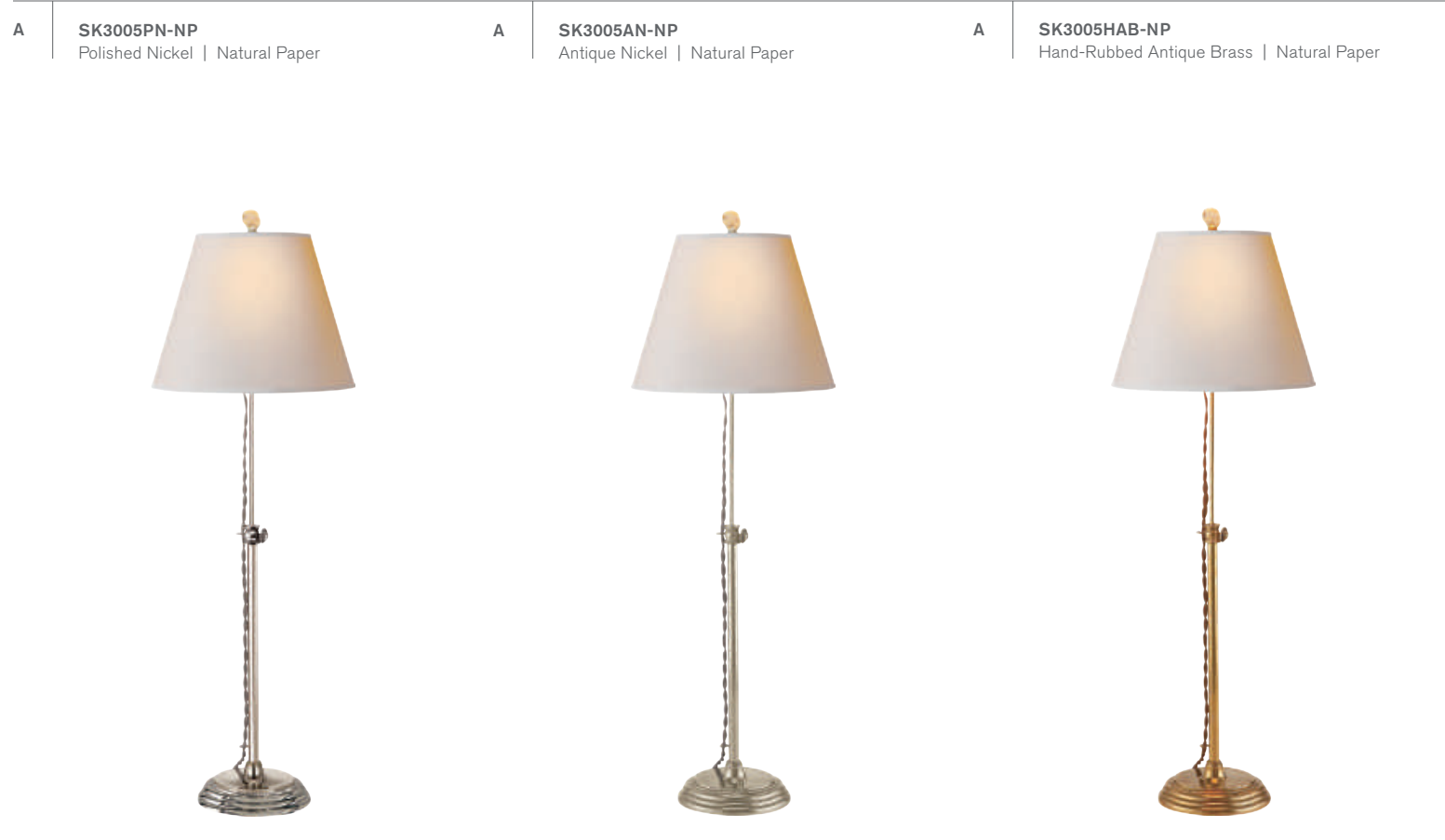

**A WYATT ACCENT LAMP**  
SUZANNE KASLER

**SK3005**  
H: 20.5" - 30" | W: 9" | Base: 5.25" Round  
Socket: E26 Hi-Lo | Bulb: 60 A  
Shade: 5" x 9" x 7"  
\* French Wired

**B DORCHESTER CLUB TABLE LAMP**  
E. F. CHAPMAN

**CHA8188**  
H: 22" - 32" | W: 13" | Base: 7" Round  
Socket: 2 - E26 Pull Chain | Bulb: 2 - 40 B  
Shade: 8" x 13" x 7"  
©EFC DESIGNS

opposite page

**C CHRISTOPHER BUFFET LAMP**  
J. RANDALL POWERS

**SP3380**  
H: 32.25" | W: 12" | Base: 6.5" Square  
Socket: E12 Candelabra | Bulb: 40 B  
**Additional Options:**  
Bronze | Linen (BZ-L)

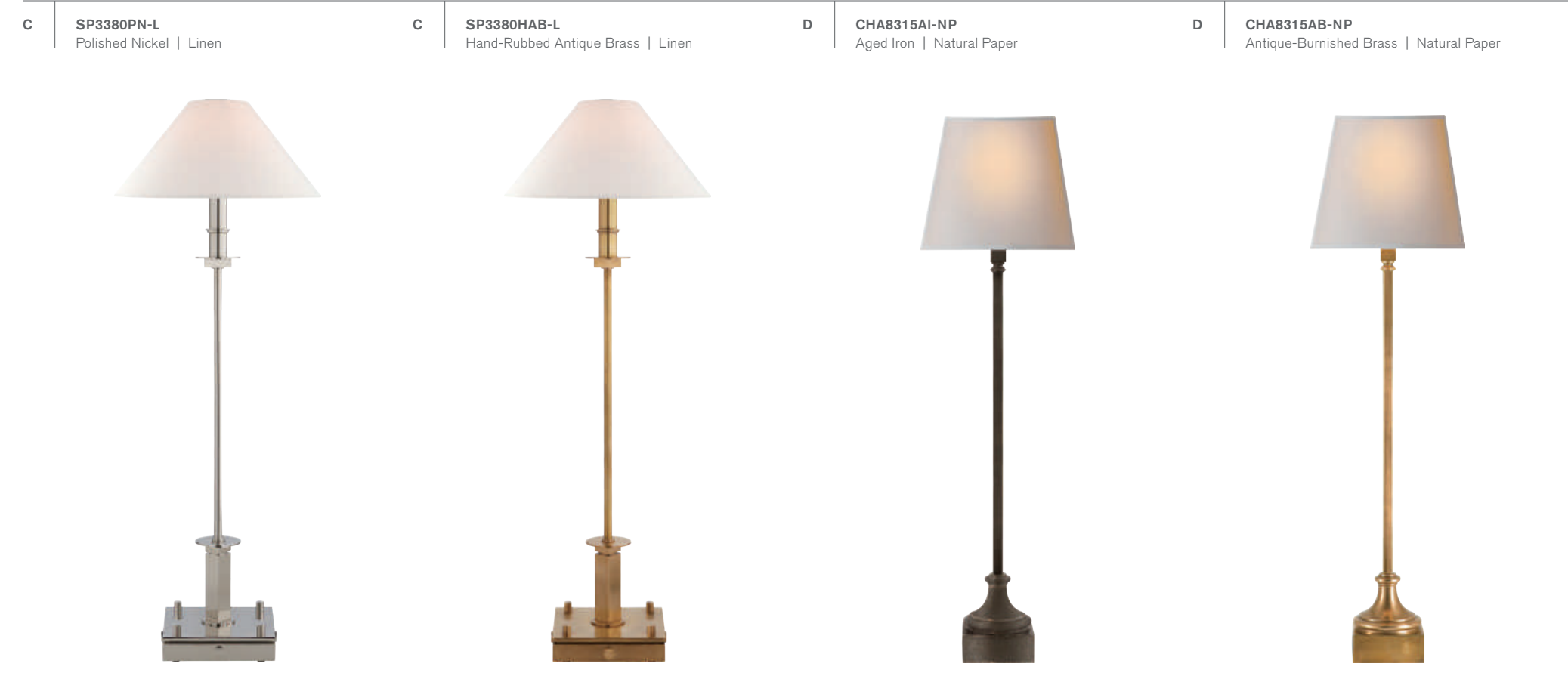

**C SP3380PN-L**  
Polished Nickel | Linen

**C SP3380HAB-L**  
Hand-Rubbed Antique Brass | Linen

**D CHA8315AI-NP**  
Aged Iron | Natural Paper

**D CHA8315AB-NP**  
Antique-Burnished Brass | Natural Paper

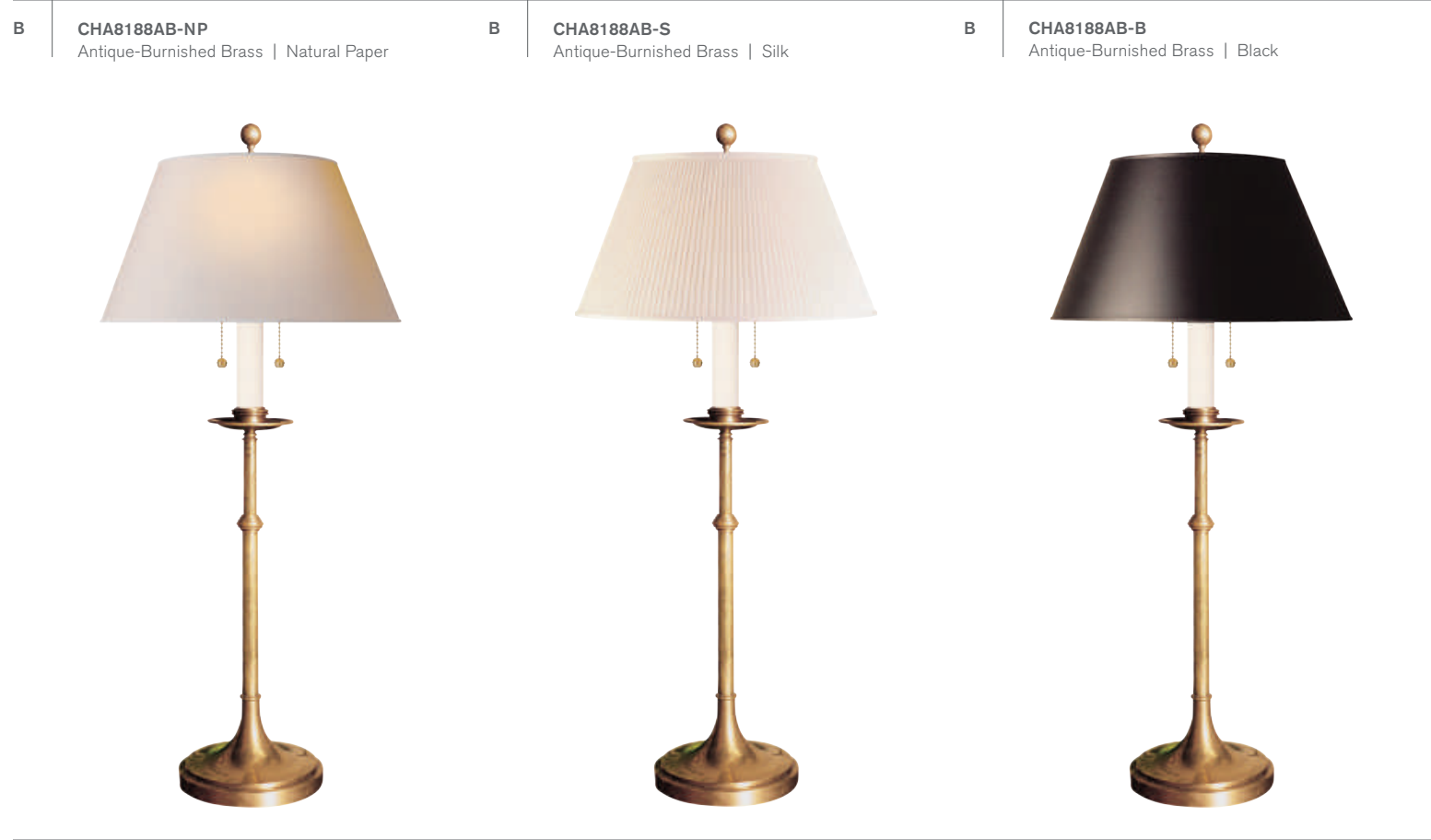

**B CHA8188AB-NP**  
Antique-Burnished Brass | Natural Paper

**B CHA8188AB-S**  
Antique-Burnished Brass | Silk

**B CHA8188AB-B**  
Antique-Burnished Brass | Black

**D CAWDOR BUFFET LAMP**  
E. F. CHAPMAN

**CHA8315**  
H: 32" | W: 9" | Base: 4.25" Square  
Socket: E26 Hi-Lo | Bulb: 60 A  
Shade: 6.5" x 9" x 8" Square  
**Additional Options:**  
Gilded Iron | Natural Paper (GI-NP)  
Polished Nickel | Natural Paper (PN-NP)  
©EFC DESIGNS

**E SWEDISH COLUMN BUFFET LAMP**  
E. F. CHAPMAN

**CHA8461**  
H: 34" | W: 10" | Base: 5.5" Square  
Socket: E26 Keyless | Bulb: 60 B  
Shade: 3.5" x 10" x 7"  
**Additional Options:**  
Crystal | Natural Paper (CG-NP)  
\* Hi-Lo Line Switch  
©EFC DESIGNS

**F JOSEPHINE TABLE LAMP**  
SUZANNE KASLER

**SK3008**  
H: 32.5" | W: 14" | Base: 5" Square  
Socket: E26 Dimmer | Bulb: 150 A  
Shade: 12" x 14" x 10"  
**Additional Options:**  
Light Blue | Antique Gold Leaf | Natural Paper (LB-NP)



**E CHA8461PN-NP**  
Polished Nickel | Natural Paper

**E CHA8461AB-NP**  
Antique-Burnished Brass | Natural Paper

**F SK3008SHS-NP**  
Sheffield Silver | Natural Paper

**F SK3008HAB-NP**  
Hand-Rubbed Antique Brass | Natural Paper

**A** **FANG GOURD TABLE LAMP**  
E. F. CHAPMAN

**CHA8627**  
H: 27" | W: 18" | Base: 6.25" Square  
Socket: E26 Dimmer | Bulb: 100 A  
Shade: 14" x 18" x 11" Rec.  
©EFC DESIGNS

**A** **CHA8627AB-NP**  
Antique-Burnished Brass | Natural Paper



**A** **CHA8627AB-NP**  
Antique-Burnished Brass | Natural Paper



**B** **CLASSICAL URN FORM MEDIUM TABLE LAMP**  
E. F. CHAPMAN

**CHA8172**  
H: 24" | W: 15" | Base: 6" Round  
Socket: 2 - E26 Pull Chain | Bulb: 2 - 40 B  
Shade: 6" x 15" x 8"  
**Additional Options:**  
Antique-Burnished Brass | Natural Paper (AB-NP)  
Antique Nickel | Black (AN-B)  
Sheffield Nickel | Natural Paper (SN-NP)  
©EFC DESIGNS

**B** **CHA8172AN-NP**  
Antique Nickel | Natural Paper



**B** **CHA8172SN-B**  
Sheffield Nickel | Black



**B** **CHA8172AB-B**  
Antique-Burnished Brass | Black



**C** **CLASSICAL URN FORM LARGE TABLE LAMP**  
E. F. CHAPMAN

**CHA8162**  
H: 35" | W: 20" | Base: 9" Round  
Socket: E26 Hi-Lo | Bulb: 100 A  
Shade: 11" x 20" x 13"  
**Additional Options:**  
Antique-Burnished Brass | Black (AB-B)  
Polished Silver | Black (PN-B)  
Sheffield Nickel | Black (SN-B)  
©EFC DESIGNS

**C** **CHA8162PS-NP**  
Polished Silver | Natural Paper



**C** **CHA8162SN-NP**  
Sheffield Nickel | Natural Paper



**C** **CHA8162AB-NP**  
Antique-Burnished Brass | Natural Paper





TABLE | FUNCTIONAL

**A CLEO LARGE DESK LAMP**  
 KELLY WEARSTLER

**KW3088**  
 H: 17.5" | W: 17.25" | Base: 5" Square  
 Socket: E26 Keyless | Bulb: 60 B  
 \* Line Switch

**B CLEO ACCENT LAMP**  
 KELLY WEARSTLER

**KW3118**  
 H: 20.75" | W: 8" | Base: 2" Round  
 Socket: E12 Candelabra | Bulb: 25 G  
 \* Line Switch

**C COQUETTE TABLE LAMP**  
 KELLY WEARSTLER

**KW3331**  
 H: 20" | W: 14" | Base: 7" Round  
 Socket: E26 Keyless | Bulb: 75 B  
 \* Line Switch

**A KW3088BZ/AB**  
 Bronze | Brass | Antique White

**A KW3088BZ/AB-BLK**  
 Bronze | Brass | Black

**D KW3410BZ/AB**  
 Bronze | Brass

**D CLEO SMALL DESK LAMP**  
 KELLY WEARSTLER

**KW3410**  
 H: 18.75" | W: 7" | Base: 7" Tripod  
 Socket: E26 Keyless | Bulb: 60 G  
 \* Line Switch



**B KW3118AB/WHT**  
 Antique-Burnished Brass | White

**B KW3118AB/BLK**  
 Antique-Burnished Brass | Black

**C KW3331AB/BLK**  
 Antique-Burnished Brass | White Marble | Black

**C KW3331PN/BLK**  
 Polished Nickel | Black Marble | Black

**D KW3410BZ/AB-BLK**  
 Bronze | Brass | Black





A ARN3006WHT  
White | Brass

A ARN3006BLK  
Black | Brass

B ARN3712WHT  
White



B ARN3712BLK  
Black



opposite page

A CHARLTON DESK LAMP  
AERIN

ARN3006  
H: 17" - 27" | W: 9.5" | Base: 8" Round  
Socket: E26 Keyless | Bulb: 60 A  
\* Toggle on Base

B AUSTEN LARGE OFFSET TABLE LAMP  
AERIN

ARN3712  
H: 25.75" | W: 10.5" | Ext: 15"  
Base: 9" x 10.5" Oval  
Socket: E26 On-Off | Bulb: 40 A

C ARN3010HAB-WHT  
Hand-Rubbed Antique Brass | White



C ARN3010HAB-HAB  
Hand-Rubbed Antique Brass



C ARN3010HAB-BLK  
Hand-Rubbed Antique Brass | Black



D TOB3212PN-AW  
Polished Nickel | Antique White



D TOB3212HAB-AW  
Hand-Rubbed Antique Brass | Antique White



D TOB3212HAB-BLK  
Hand-Rubbed Antique Brass | Black



C CLEMENTE DESK LAMP  
AERIN

ARN3010  
H: 20.75" | W: 7" | Ext: 15.5"  
Base: 7" Round  
Socket: E26 Keyless | Bulb: 60 A  
\* Toggle on Base

D ANTONIO DESK LAMP  
THOMAS O'BRIEN

TOB3212  
H: 24" - 28" | W: 11" | Ext: 11" - 18.25"  
Base: 11" Round  
Socket: E26 On-Off | Bulb: 60 A  
Shade: 2.25" x 4.5" x 8"

**A** **TOTIE TASK LAMP**  
THOMAS O'BRIEN

**TOB3142**  
H: 11" | W: 7" | Base: 5.5" Round  
Socket: E26 Dimmer | Bulb: 40 A

**A** **TOB3142PN**  
Polished Nickel

**A** **TOB3142HAB**  
Hand-Rubbed Antique Brass

**A** **TOB3142BZ**  
Bronze

**B** **TOB3513BZ/HAB-BZ**  
Bronze | Brass | Bronze

**B** **WHITMAN DESK LAMP**  
THOMAS O'BRIEN

**TOB3513**  
H: 19" | W: 12.75" | Base: 7.75" Round  
Socket: E26 Keyless | Bulb: 60 B  
\* Switch on Base



**B** **TOB3513PN-WG**  
Polished Nickel | White Glass

**B** **TOB3513PN-PN**  
Polished Nickel | Polished Nickel

**B** **TOB3513HAB-WG**  
Hand-Rubbed Antique Brass | White Glass

**B** **TOB3513HAB-HAB**  
Hand-Rubbed Antique Brass | Brass





**A** **HENLEY TASK LAMP**  
THOMAS O'BRIEN

**TOB3197**  
H: 13" | W: 8.5" | Base: 6" Round  
Socket: E26 Hi-Lo | Bulb: 60 A

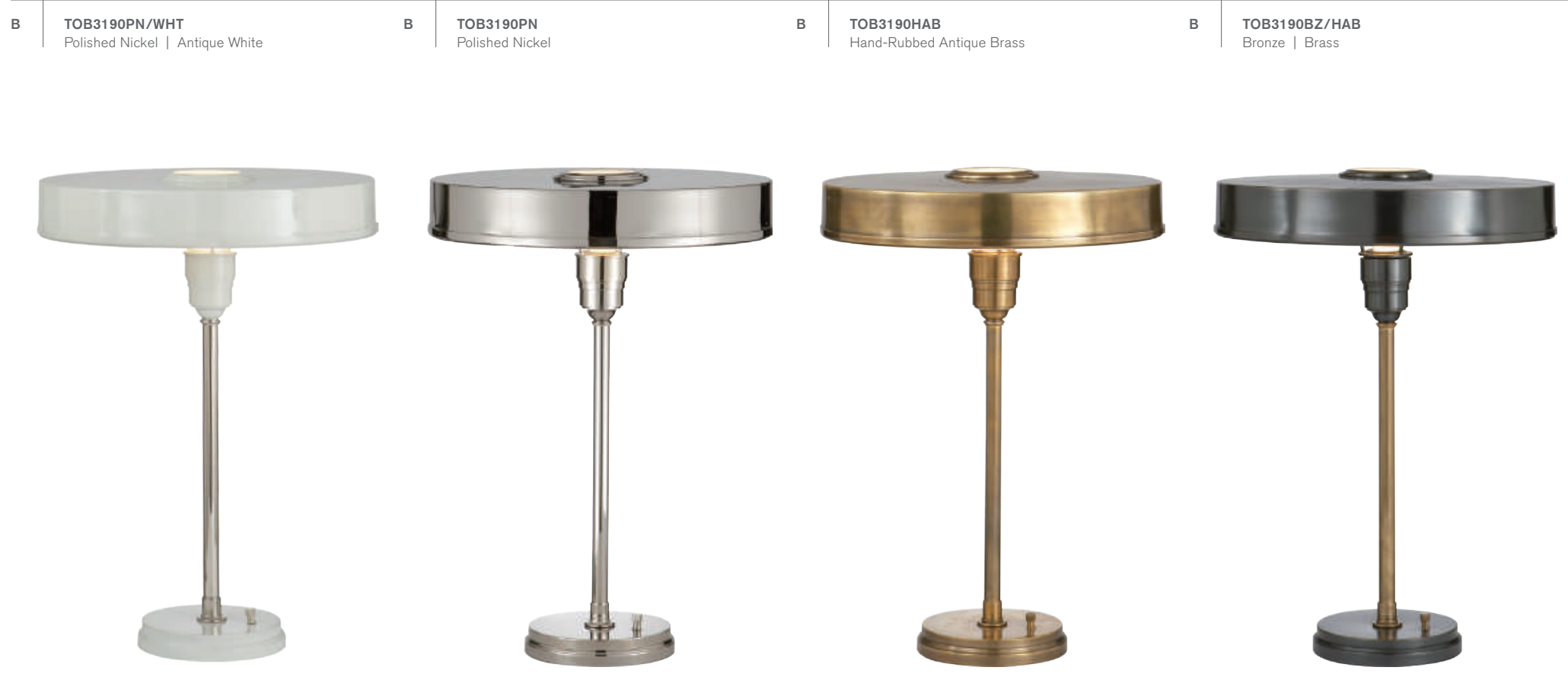

**B** **CARLO TABLE LAMP**  
THOMAS O'BRIEN

**TOB3190**  
H: 21" | W: 15.5" | Base: 6.76" Round  
Socket: E26 Keyless | Bulb: 60 A  
Shade: 3" x 15.5"  
\* Hi-Lo Switch on Base



**B** **TOB3190PN/WHT**  
Polished Nickel | Antique White

**A** **TOB3290PN-L**  
Polished Nickel | Linen

**A** **TOB3290HAB-L**  
Hand-Rubbed Antique Brass | Linen

**A** **TOB3290BZ/HAB-L**  
Bronze | Hand-Rubbed Antique Brass | Linen



**A** **OSIRIS REFLECTOR TABLE LIGHT**  
THOMAS O'BRIEN

**TOB3290**  
H: 19" | W: 9.25" | Base: 9.25" Round  
Socket: E26 On/Off | Bulb: 60 A

**B** **OSIRIS REFLECTOR ADJUSTABLE TABLE LIGHT**  
THOMAS O'BRIEN

**TOB3291**  
H: 28.5" - 38.5" | W: 12.5" | Base: 9.25" Round  
Socket: E26 On/Off | Bulb: 60 A

**B** **TOB3291PN-L**  
Polished Nickel | Linen

**B** **TOB3291HAB-L**  
Hand-Rubbed Antique Brass | Linen

**B** **TOB3291BZ/HAB-L**  
Bronze | Hand-Rubbed Antique Brass | Linen



opposite page

**C** **LOLA SMALL DESK LAMP**  
IAN K. FOWLER

**S3260**  
H: 12" | W: 5.5" | Ext: 17.75"  
Base: 5.5" T-Shape  
Socket: E26 Dimmer | Bulb: 40 T



**C** **S3260AI-HAB**  
Aged Iron | Hand-Rubbed Antique Brass



A | **ARN3042HAB**  
Hand-Rubbed Antique Brass



A | **LANCELOT PIVOTING DESK LAMP**  
AERIN

**ARN3042**  
H: 20.5" | W: 6" | Ext: 7.5"  
Base: 6" Round  
Socket: E17 In-Line Switch | Bulb: 4.5W LED R14

B | **ROUSSEAU BOOM ARM TABLE LAMP**  
KELLY WEARSTLER

**KW3585**  
H: 20.5" | W: 5.5" | Ext: 16"  
Base: 5.5" Round | LED: 10w  
\* Dimmer

B | **KW3585PN-EC**  
Polished Nickel | Etched Crystal

B | **KW3585AB-EC**  
Antique-Burnished Brass | Etched Crystal

B | **KW3585BZ-EC**  
Bronze | Etched Crystal



A | **ARN3042PN**  
Polished Nickel

C | **GOODMAN DESK LAMP**  
THOMAS O'BRIEN

**TOB3536**  
H: 19" - 30" | Ext: 17 - 23" | Base: 7" Round  
Socket: E26 On-Off | Bulb: 60 A

C | **TOB3536PN**  
Polished Nickel

C | **TOB3536HAB**  
Hand-Rubbed Antique Brass

C | **TOB3536BZ/HAB**  
Bronze | Hand-Rubbed Antique Brass



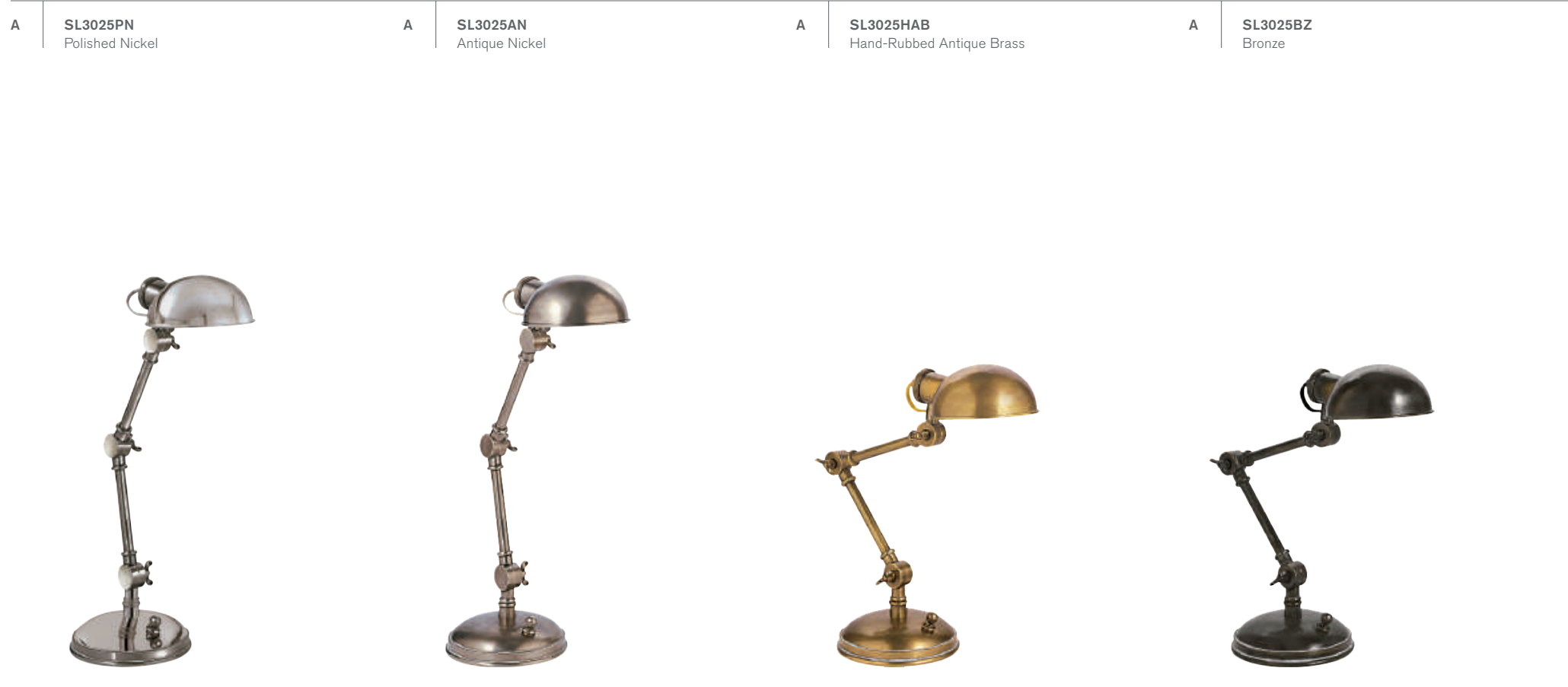

<b>A</b>   <b>SL3025PN</b> Polished Nickel	<b>A</b>   <b>SL3025AN</b> Antique Nickel	<b>A</b>   <b>SL3025HAB</b> Hand-Rubbed Antique Brass	<b>A</b>   <b>SL3025BZ</b> Bronze
---	--	--	--------------------------------------



<b>B</b>   <b>CHA8150PN-PN</b> Polished Nickel	<b>B</b>   <b>CHA8150AN-AN</b> Antique Nickel	<b>B</b>   <b>CHA8150AB-AB</b> Antique-Burnished Brass	<b>B</b>   <b>CHA8150AB-LC</b> Antique-Burnished Brass   Linen Collar
---	--	---	--

opposite page

**A THE PIXIE DESK LAMP**  
E. F. CHAPMAN

**SL3025**  
H: 13" - 18.5" | Ext: 16" | Base: 5.5" Round  
Socket: E12 Candelabra | Bulb: 25 B  
Shade: 4.75" x 2.25"  
\* Hi-Lo in Base  
©EFC DESIGNS

**B PIMLICO TABLE LAMP**  
E. F. CHAPMAN

**CHA8150**  
H: 25" - 32.5" | Ext: 20.5" | Base: 6" Round  
Socket: E26 Hi-Lo | Bulb: 60 A  
Shade: 5" x 9" x 7.5"  
©EFC DESIGNS

**C ASPEN DESK LAMP**  
IAN K. FOWLER

**S3030**  
H: 24.25" - 31.75" | W: 6.25" | Ext: 19.75"  
Base: 6.25" x 8.75" Rec.  
Socket: E12 Candelabra | Bulb: 60 B  
Shade: 6" x 6" x 4.5"  
\* Line Switch



**C S3030GI-NP**  
Gilded Iron | Natural Paper

**C S3030BR-NP**  
Black Rust | Natural Paper



A **BBL3090DW/SB-L**  
Dark Walnut | Soft Brass | Linen



A **BBL3090DW/PN-L**  
Dark Walnut | Polished Nickel | Linen



A **BBL3090DW/SB-L**  
Dark Walnut | Soft Brass | Linen



B **SK3115PN-L**  
Polished Nickel | Linen



C **TOB3222AI-NP**  
Aged Iron | Natural Paper



B **SK3115HAB-L**  
Hand-Rubbed Antique Brass | Linen



C **TOB3222GI-NP**  
Gilded Iron | Natural Paper



opposite page

A **STYLUS LARGE ANGLED TABLE LAMP**  
BARBARA BARRY

**BBL3090**  
H: 33" | W: 16" | Ext: 17"  
Base: 10" Round  
Socket: E26 On-Off | Bulb: 75 A  
Shade: 16" x 16" x 10"

D **ARN3003HAB-L**  
Hand-Rubbed Antique Brass | Linen



D **ARN3003BLK-L**  
Hand-Rubbed Antique Brass | Black | Linen



B **GRAVES DESK LAMP**  
SUZANNE KASLER

**SK3115**  
H: 18.25" - 28.75" | W: 13.25 - 16.5"  
Base: 5.5" x 7.75" Rec.  
Socket: E26 Keyless | Bulb: 75 A  
Shade: 4.5" x 8" x 7.5"  
\* On/Off Switch on Base

C **MIA TABLE LAMP**  
THOMAS O'BRIEN

**TOB3222**  
H: 28.5" | W: 16.25" | Base: 8.5" Round  
Socket: E26 Hi-Lo | Bulb: 60 A  
Shade: 4.5" x 6" x 8"  
**Additional Options:**  
Polished Nickel | Natural Paper (PN-NP)

D **CLARKSON TABLE LAMP**  
AERIN

**ARN3003**  
H: 17" | W: 8" | Base: 7.5" Round  
Socket: E12 Keyless | Bulb: 40 B  
Shade: 3.75" x 5" x 5.5"  
\* Line Switch



**A** **TOB3725PN**  
Polished Nickel | Crystal



**A** **TOB3725BZ**  
Bronze | Crystal

**B** **SP3041HAB**  
Hand-Rubbed Antique Brass | Crystal



**B** **SP3041PN**  
Polished Nickel | Crystal



**B** **SP3041BZ**  
Bronze | Crystal



**C** **AH3500PN**  
Polished Nickel



opposite page

**A** **JENNINGS PHARMACY TABLE LAMP**  
THOMAS O'BRIEN

**TOB3725**  
H: 16.5" - 26.5" | W: 5" | Ext: 13.25"  
Base: 5" x 8.25" Rec.  
Socket: E26 Hi-Lo | Bulb: 60 T

**B** **MCCLEAN EASEL LIGHT**  
J. RANDALL POWERS

**SP3041**  
H: 19.75" | W: 12" | Base: 7" x 11.75" Rec.  
Socket: 2 - E12 Candelabra | Bulb: 2 - 40 B  
\* Line Switch

**C** **ESTELLE DISPLAY LAMP**  
ALEXA HAMPTON

**AH3500**  
H: 22.25" | W: 16" | Base: 14.5" x 15.5" Triangle  
Socket: E12 Candelabra | Bulb: 40 B  
\* Lamp Adjusts Vertically  
\* Line Switch  
\* Art Not Included

**C** **AH3500NB**  
Natural Brass



**C** **AH3500GM**  
Gun Metal





FLOOR



FLOOR | DECORATIVE

**A** **BEAUMONT FLOOR LAMP**  
AERIN

**ARN1301**  
H: 62.75" | W: 20" | Base: 10.25" Round  
Socket: 2 - E26 Keyless | Bulb: 2 - 60 A  
Shade: 18" x 20" x 14"  
**Additional Options:**  
Burnished Silver Leaf | Linen (BSL-L)  
\* Dimmer

**B** **WALKER MEDIUM FLOOR LAMP**  
kate spade new york

**KS1070**  
H: 58" | W: 17" | Base: 10" Round  
Socket: E26 In-Line Switch | Bulb: 100 A  
Shade: 17" x 17" x 10"  
**Additional Options:**  
Burnished Silver Leaf | Cream Linen (BSL-L)



**A** | **ARN1301AI-L**  
Aged Iron | Linen

**A** | **ARN1301WHT-L**  
Matte White | Linen

**A** | **ARN1301G-L**  
Gild | Linen

**B** | **KS1070LC-NL**  
Light Cream | Natural Linen

**B** | **KS1070G-L/BL**  
Gild | Cream Linen | Black Linen





**A** | **ARN1070PW-L**  
Plaster White | Linen

**A** | **ARN1070G-L**  
Gild | Linen

**B** | **BBL1002WHT-S**  
Matte White | Silk

**B** | **BBL1002G-S**  
Gild | Silk



**B** | **BBL1002G-S**  
Gild | Silk

**A** | **LILIAN FLOOR LAMP**  
AERIN

**ARN1070**  
H: 64.5" | W: 21.5" | Base: 15" Round  
Socket: 2 - E26 Dimmer | Bulb: 2 - 75 A  
Shade: 21.5" x 21.5" x 15" Round

**B** | **LOTUS FLOOR LAMP**  
BARBARA BARRY

**BBL1002**  
H: 68.5" | W: 17" | Base: 13" Round  
Socket: E26 Dimmer | Bulb: 150 A  
Shade: 16" x 17" x 13"



A | **ARN1080PW-L**  
Plaster White | Linen

A | **ARN1080G-L**  
Gild | Linen

A | **ARN1080AI-L**  
Aged Iron | Linen

B | **JN1002PW-L**  
Plaster White | Linen

B | **JN1002BSL-L**  
Burnished Silver Leaf | Linen

B | **JN1002AGL-L**  
Antique Gold Leaf | Linen



A | **FLIANA FLOOR LAMP**  
AERIN

**ARN1080**  
H: 58.5" | W: 17.5" | Base: 17.5"  
Socket: E26 Dimmer | Bulb: 100 A  
Shade: 15" x 17.5" x 16"



B | **ALBERTO LARGE FLOOR LAMP**  
JULIE NEILL

**JN1002**  
H: 60" | W: 18" | Base: 10.75" Round  
Socket: E26 Dimmer | Bulb: 100 A  
Shade: 15" x 18" x 12.5"



A | ARN1002G-L  
Gild | Linen

A | DOVER FLOOR LAMP  
AERIN

ARN1002  
H: 63.5" | W: 21.5" | Base: 9" Round  
Socket: E26 Dimmer | Bulb: 150 A  
Shade: 18" x 21.5" x 13"

B | BRISTOL FLOOR LAMP  
AERIN

ARN1022  
H: 65" | W: 22" | Base: 11.5" Round  
Socket: 2 - E26 Keyless | Bulb: 2 - 60 A  
Shade: 18" x 22" x 15.5"  
**Additional Options:**  
Gilded | Linen (G-L)  
\* Dimmer

A | ARN1002BSL-L  
Burnished Silver Leaf | Linen

A | ARN1002AI-L  
Aged Iron | Linen

B | ARN1022BSL-L  
Burnished Silver Leaf | Linen

B | ARN1022AI-L  
Aged Iron | Linen



**A** **S1430GI-L**  
Gilded Iron | Linen

**A** **S1430AI-L**  
Aged Iron | Linen



**A** **TALISMAN LARGE FLOOR LAMP**  
IAN K. FOWLER

**S1430**  
H: 68" | W: 22" | Base: 11.75" Round  
Socket: E26 Dimmer | Bulb: 100 A  
Shade: 20" x 22" x 13.75"

**B** **VIVIER LARGE FLOOR LAMP**  
THOMAS O'BRIEN

**TOB1502**  
H: 69" | W: 21" | Base: 11.5" Round  
Socket: 2 - E26 Pull Chain | Bulb: 2 - 60 A  
Shade: 17.5" x 21" x 14"

**B** **TOB1502BK/HAB-L**  
Blackened Iron | Hand-Rubbed Antique Brass | Linen



opposite page

**C** **STRIE FLOOR LAMP**  
E. F. CHAPMAN

**CHA9707**  
H: 63" | W: 19" | Base: 16" Tripod  
Socket: E26 Hi-Lo | Bulb: 150 A  
Shade: 14" x 19" x 12"  
©EFC DESIGNS

**D** **PARISH FLOOR LAMP**  
THOMAS O'BRIEN

**TOB1152**  
H: 65.25" | W: 19" | Base: 19.5" Tripod  
Socket: 2 - E26 Pull Chain | Bulb: 2 - 60 A  
Shade: 15" x 19" x 16.5"

**C** **CHA9707GI-NP**  
Gilded Iron | Natural Paper

**C** **CHA9707AI-NP**  
Aged Iron | Natural Paper



**D** **TOB1152GI-NP**  
Gilded Iron | Natural Paper

**D** **TOB1152AI-NP**  
Aged Iron | Natural Paper



**A** **SP1003GI-NP**  
Gilded Iron | Natural Paper



**A** **SP1003AI-NP**  
Aged Iron | Natural Paper



**B** **SK1505GI-NP**  
Gilded Iron | Natural Paper



**B** **SK1505AI-NP**  
Aged Iron | Natural Paper



opposite page

**A** **WELLS FLOOR LAMP**  
J. RANDALL POWERS  
  
**SP1003**  
H: 70.25" | W: 19" | Base: 19" Tripod  
Socket: E26 Hi-Lo | Bulb: 150 A  
Shade: 18" x 19" x 12.5"

**B** **MADELEINE FLOOR LAMP**  
SUZANNE KASLER  
  
**SK1505**  
H: 66" | W: 21" | Base: 22" Tripod  
Socket: E26 Hi-Lo | Bulb: 150 A  
Shade: 14" x 21" x 14"  
**Additional Options:**  
Belgian White | Natural Paper (BW-NP)

**C** **ALBERT PETITE TRI-LEG FLOOR LAMP**  
J. RANDALL POWERS  
  
**SP1009**  
H: 59" | W: 15" | Base: 18.75" Tripod  
Socket: E26 Dimmer | Bulb: 75 A  
Shade: 11" x 15" x 10"  
**Additional Options:**  
Gilded Iron | Natural Percalé (GI-PL)

**C** **SP1009AI-PL**  
Aged Iron | Natural Percalé





**A** | **SR1201T-NP**  
Greek Key Tole | Natural Paper

**A** | **SR1201T-NP**  
Greek Key Tole | Natural Paper

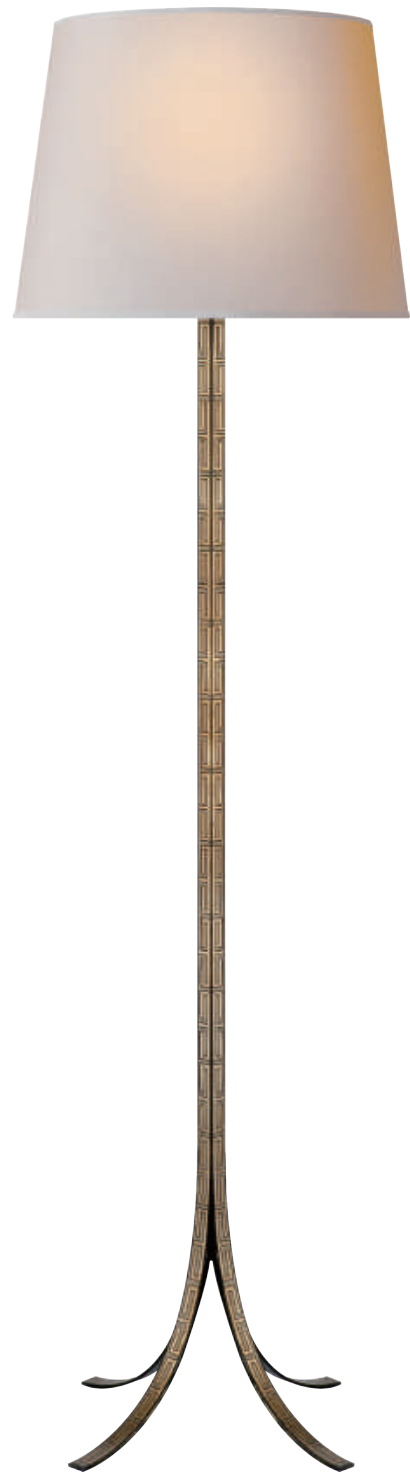

opposite page

**A** | **MAKIS FLOOR LAMP**  
JOHN ROSSELLI

**SR1201**  
H: 68.5" | W: 20" | Base: 18.75" Cross  
Socket: 2 - E26 Pull Chain | Bulb: 2 - 60 A  
Shade: 15" x 20" x 14"

**B** | **ETOILE LARGE FLOOR LAMP**  
IAN K. FOWLER

**S1320**  
H: 71.75" | W: 16" | Base: 15.5" Cross  
Socket: E26 Dimmer | Bulb: 100 A  
Shade: 13.75" x 16" x 18"

**B** | **S1320PN-NP**  
Polished Nickel | Natural Paper



**B** | **S1320GI-NP**  
Gilded Iron | Natural Paper



**B** | **S1320AI-NP**  
Aged Iron | Natural Paper



A	<b>SK1500BW-L</b> Belgian White   Linen	A	<b>SK1500GI-L</b> Gilded Iron   Linen	B	<b>NW1011VS-S</b> Venetian Silver   Silk	B	<b>NW1011VG-S</b> Venetian Gold   Silk
---	--	---	--	---	---	---	---

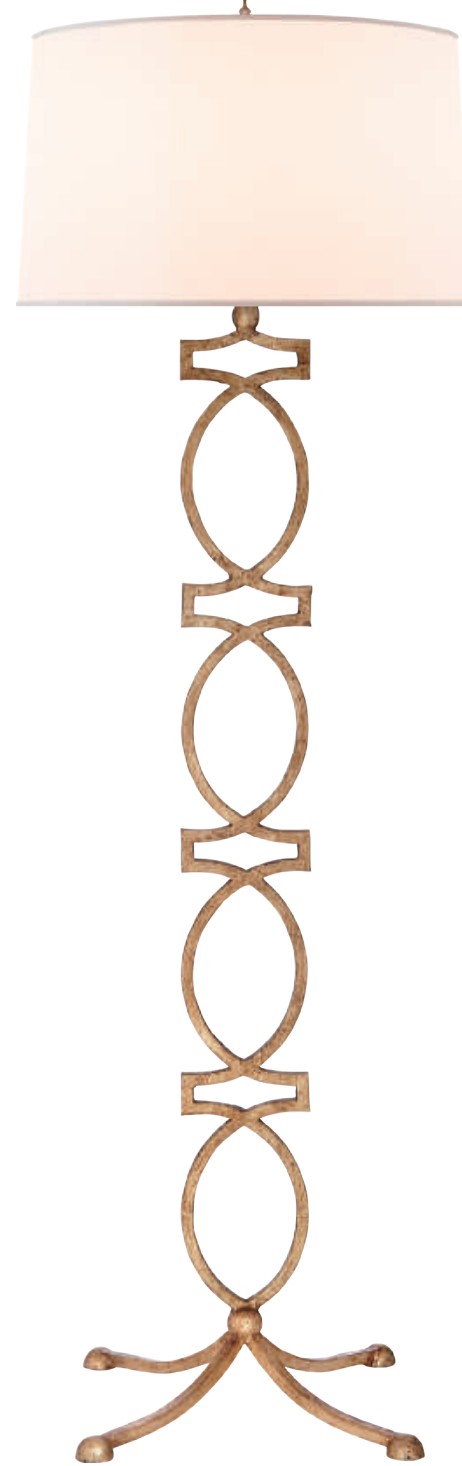
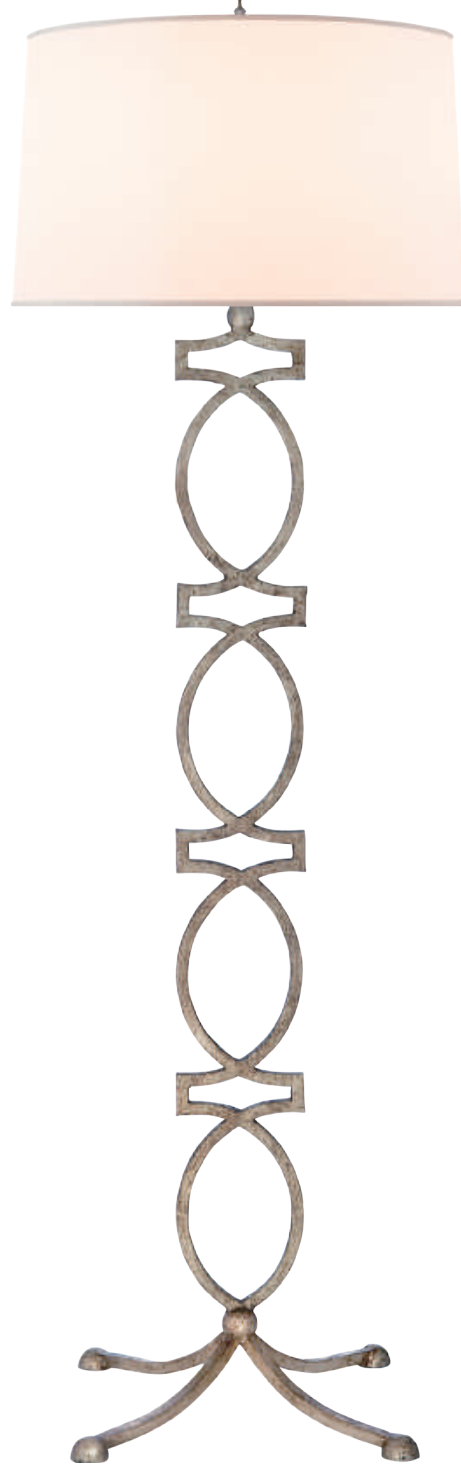

**A QUATREFOIL FLOOR LAMP**  
SUZANNE KASLER

**SK1500**  
H: 68" | W: 20" | Base: 20" Cross  
Socket: 2 - E26 Pull Chain | Bulb: 2 - 75 A  
Shade: 19.5" x 20" x 13"  
**Additional Options:**  
Aged Iron | Linen

**B BRITTANY FLOOR LAMP**  
NIERMANN WEEKS

**NW1011**  
H: 67.5" | W: 22" | Base: 14.25" Square  
Socket: E26 Dimmer | Bulb: 60 A  
Shade: 20" x 22" x 13"

B	<b>NW1011AI-S</b> Aged Iron   Silk
---	---------------------------------------



A | ARN1025G-L  
Gild | Linen



A | MONTREUIL FLOOR LAMP  
AERIN

**ARN1025**  
H: 67" | W: 16,75" | Base: 10" Round  
Socket: 4 - E12 Candelabra | Bulb: 4 - 40 B  
Shade: 3,5" x 6" x 8"  
\* Line Switch

B | ARN1027BSL-L  
Burnished Silver Leaf | Linen

B | ARN1027G-L  
Gild | Linen

B | ARN1027AI-L  
Aged Iron | Linen



opposite page

B | LEBON FLOOR LAMP  
AERIN

**ARN1027**  
H: 62,25" | W: 27" | Base: 20" Tripod  
Socket: E26 Dimmer | Bulb: 150 A  
Shade: 20" x 27" x 15,5"

**A** **S1400GI-NP**  
Gilded Iron | Natural Paper



**A** **S1400AI-NP**  
Aged Iron | Natural Paper



**A** **DAUPHINE FLOOR LAMP**  
STUDIO VC  
**S1400**  
H: 54" | W: 18.5" | Base: 10" Round  
Socket: E26 Hi-Lo | Bulb: 150 A  
Shade: 17.5" x 18.5" x 12.5"  
\* French Wired

**B** **S1641AI-PL**  
Aged Iron | Percale



**B** **TRIAD HAND-FORGED FLOOR LAMP**  
IAN K. FOWLER  
**S1641**  
H: 65.75" | W: 22.5" | Base: 15.75" Tripod  
Socket: E26 Keyless | Bulb: 100 A  
Shade: 19" x 22.5" x 14.5"  
\* Foot Switch  
\* French Wired

**C** **TOB1390AI/HAB-L**  
Aged Iron | Hand-Rubbed Antique Brass | Linen



**C** **TAVARES LARGE FLOOR LAMP**  
THOMAS O'BRIEN

**TOB1390**  
H: 70.5" | W: 21.75" | Base: 21.75" Tripod  
Socket: E26 Dimmer | Bulb: 100 A  
Shade: 15" x 16" x 17"



A

**TOB1155GI-NP**  
Gilded Iron | Natural Paper



A

**TOB1155AI-NP**  
Aged Iron | Natural Paper

A

**TOB1155GI-NP**  
Gilded Iron | Natural Paper

B

**SK1008AI-L**  
Aged Iron | Linen

B

**SK1008G-L**  
Gild | Linen



**A HANNAH FLOOR LAMP**  
THOMAS O'BRIEN

**TOB1155**  
H: 73" | W: 24.5" | Base: 13.75" Cross  
Socket: 2 - E26 Keyless | Bulb: 2 - 75 A  
Shade: 15.5" x 24.5" x 18"  
\* Pull Chain

**B MOD FLOOR LAMP**  
SUZANNE KASLER

**SK1008**  
H: 64" | W: 20" | Base: 8" x 12" Rec.  
Socket: E26 Hi-Lo | Bulb: 150 A  
Shade: 19" x 20" x 13" Rec.  
**Additional Options:**  
Burnished Silver Leaf | Linen (BSL-L)

- A **S1050BR-NP**  
Blackened Rust | Natural Paper
- A **S1050GI-NP**  
Gilded Iron | Natural Paper
- B **S1052AI-NP**  
Aged Iron | Natural Paper
- B **S1052GI-NP**  
Gilded Iron | Natural Paper

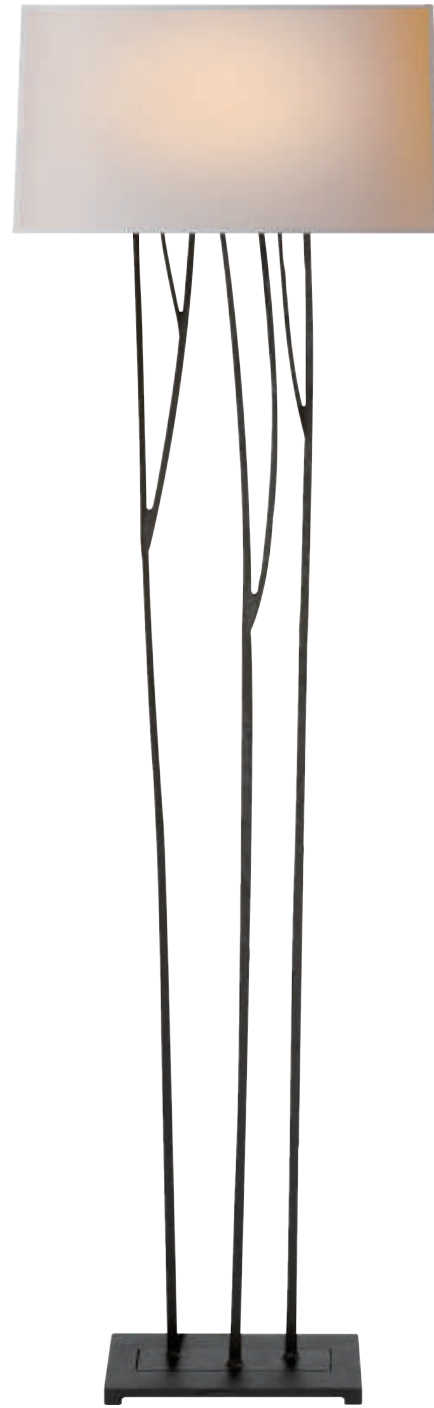

opposite page

**A ASPEN FLOOR LAMP**  
IAN K. FOWLER

**S1050**  
H: 59.5" | W: 17.75" | Base: 11" x 7" Rec.  
Socket: 2 - E26 Keyless | Bulb: 2 - 60 A  
Shade: 17" x 17.75" x 9.5" Rec.  
\* In-Line Switch

**B VAIL FLOOR LAMP**  
IAN K. FOWLER

**S1052**  
H: 64" | W: 19.5" | Base: 15.75" Sculptural  
Socket: E26 Keyless | Bulb: 150 A  
Shade: 19.5" x 19.5" x 11" Nordy  
\* Line Switch

- C **S1513AI-PL**  
Aged Iron | Percalé

**C SCALA LARGE HAND-FORGED FLOOR LAMP**  
IAN K. FOWLER

**S1513**  
H: 62.5" | W: 20.5"  
Socket: E26 Dimmer | Bulb: 100 A  
Shade: 20.5" x 20.5" x 11"  
**Additional Options:**  
Gilded Iron | Percalé (GI-PL)  
\* French Wired



**A** **CHA9461GI-NP**  
Gilded Iron | Natural Paper



**A** **CHA9461AI-NP**  
Aged Iron | Natural Paper



**A** **FLUTED SPIRE FLOOR LAMP**  
E. F. CHAPMAN  
  
**CHA9461**  
H: 60.5" | W: 19" | Base: 6.5" Round  
Socket: E26 Dimmer | Bulb: 150 A  
Shade: 14" x 19" x 12"  
©EFC DESIGNS

**B** **CACHET FLOOR LAMP**  
KELLY WEARSTLER

**KW1135**  
H: 61" | W: 20" | Base: 6" Round  
Socket: E26 Keyless | Bulb: 12 LED A  
Shade: 14" x 20" x 19.5"  
\* Foot Pedal

**B** **KW1135AI-L**  
Aged Iron | Linen



opposite page

**C** **ZEPHYR LARGE FLOOR LIGHT**  
KELLY WEARSTLER

**KW1130**  
H: 63" | W: 20" | Base: 7.5" Round  
Socket: 2 - E26 Pull Chain | Bulb: 2 - 60 A  
Shade: 17" x 20" x 14"

**C** **KW1130AI-L**  
Aged Iron | Linen



**C** **KW1130AI-L**  
Aged Iron | Linen



A

KS1071CG-L  
Crystal | Cream Linen



**A CASTLE PEAK NARROW FLOOR LAMP**  
kate spade new york

**KS1071**  
H: 63.25" | W: 18.5" | Base: 10" Square  
Socket: E26 In-Line Switch | Bulb: 100 A  
Shade: 18.5" x 18.5" x 13.5"

**B WRIGHT LARGE FLOOR LAMP**  
STUDIO VC

**S1702**  
H: 63.25" | W: 19" | Base: 7" Rec.  
Socket: E26 Dimmer | Bulb: 100 A  
Shade: 16.5" x 19" x 12"

A

KS1071CG-L  
Crystal | Cream Linen



B

S1702PN-L  
Polished Nickel | Linen



B

S1702GI-L  
Gilded Iron | Linen



<p><b>A</b>   <b>ARN1005PN/CG-L</b> Polished Nickel   Clear Glass   Linen</p>	<p><b>A</b>   <b>ARN1005HAB/CG-L</b> Hand-Rubbed Antique Brass   Clear Glass   Linen</p>	<p><b>B</b>   <b>KS1005PN/WM-CG</b> Polished Nickel   White Marble   Clear Glass   Pearls</p>	<p><b>B</b>   <b>KS1005SB/WM-CG</b> Soft Brass   White Marble   Clear Glass   Pearls</p>
---	--	---	--

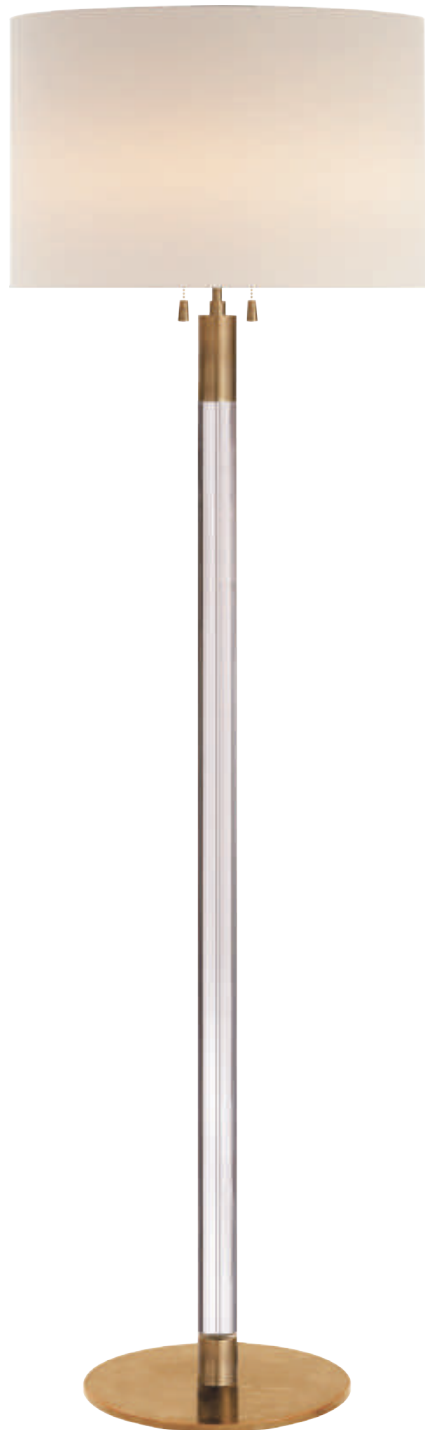
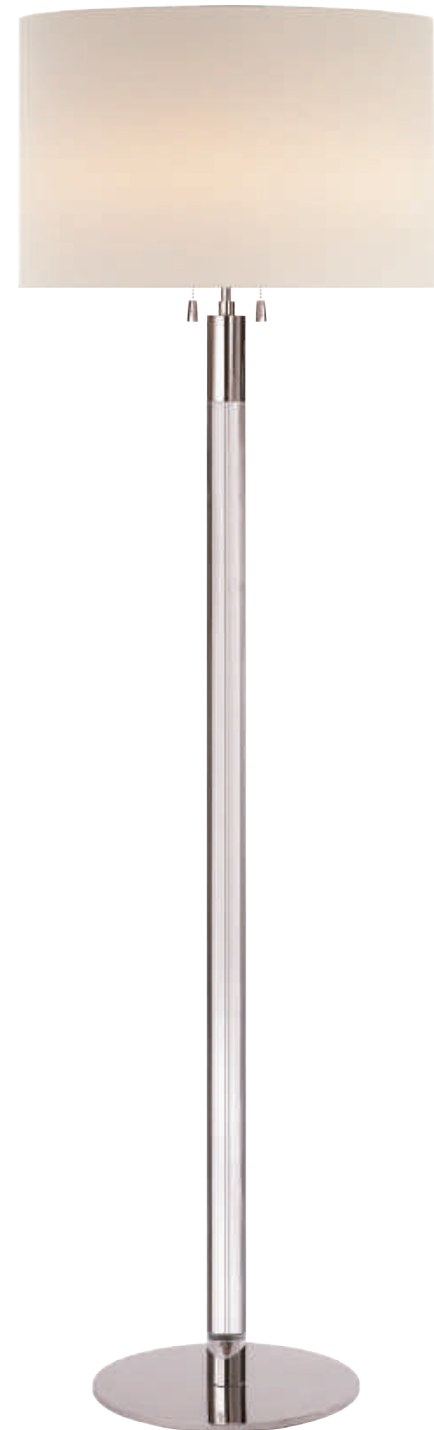

<p><b>B</b>   <b>KS1005SB/WM-CG</b> Soft Brass   White Marble   Clear Glass   Pearls</p>
--



- A** | **RIGA FLOOR LAMP**  
AERIN
  
- ARN1005**  
H: 60.25" | W: 20" | Base: 12" Round  
Socket: 2 - E26 Pull Chain | Bulb: 2 - 60 A  
Shade: 19.5" x 20" x 13"  
\* French Wired
  
- B** | **DICKINSON FLOOR LAMP**  
kate spade new york
  
- KS1005**  
H: 66.75" | W: 17" | Base: 6.5" Square  
Socket: 13 - E12 Candelabra | Bulb: 13 - 40 G



**A** **CL1002AI-NP**  
Aged Iron | Natural Paper

**A** **TRIBECA FLOOR LAMP**  
CLODAGH

**CL1002**  
H: 53" | W: 8" | Base: 8" Square  
Socket: E26 Pull Chain | Bulb: 75 A  
Shade: 7.5" x 7.5" x 9"

opposite page

**B** **LONGACRE FLOOR LAMP**  
THOMAS O'BRIEN

**TOB1000**  
H: 64.5" | W: 22" | Base: 15" Round  
Socket: 2 - E26 Pull Chain | Bulb: 2 - 75 A  
Shade: 22" x 22" x 12.5"  
**Additional Options:**  
Hand-Rubbed Antique Brass | Natural Paper (HAB-NP)

**C** **REFINED RIB LARGE FLOOR LAMP**  
BARBARA BARRY

**BBL1036**  
H: 64.75" | W: 18" | Base: 12" Round  
Socket: E26 Dimmer | Bulb: 100 A  
Shade: 17" x 18" x 15"

**B** **TOB1000PN-NP**  
Polished Nickel | Natural Paper

**B** **TOB1000BZ-NP**  
Bronze | Natural Paper

**C** **BBL1036CW-L**  
China White | Linen

**C** **BBL1036EBO-L**  
Ebony | Linen





**A** **BBL1030PWT-L**  
Pewter | Linen

**A** **BBL1030SB-L**  
Soft Brass | Linen

**A** **BBL1030BZ-L**  
Bronze | Linen

**A** **LYRIC BRANCH FLOOR LAMP**  
BARBARA BARRY

**BBL1030**  
H: 59" | W: 18" | Base: 8" x 13" Rec.  
Socket: E26 Dimmer | Bulb: 100 A  
Shade: 18" x 18" x 11"

opposite page

**B** **HACKNEY FLOOR LAMP**  
J. RANDALL POWERS

**SP1022**  
H: 52.25" | W: 14" | Base: 9" Round  
Socket: E26 Keyless | Bulb: 40 B  
Shade: 4" x 14" x 7.75"

**Additional Options:**  
Bronze | Natural Paper (BZ-NP)  
\* Line Switch

**C** **HACKNEY BRIDGE FLOOR LAMP**  
J. RANDALL POWERS

**SP1023**  
H: 52" | W: 11.75" | Ext: 17" | Base: 8.5" Round  
Socket: E26 Keyless | Bulb: 40 B  
Shade: 3" x 11.75" x 7"

**Additional Options:**  
Antique Brass | Natural Paper (HAB-NP)  
\* Foot Switch

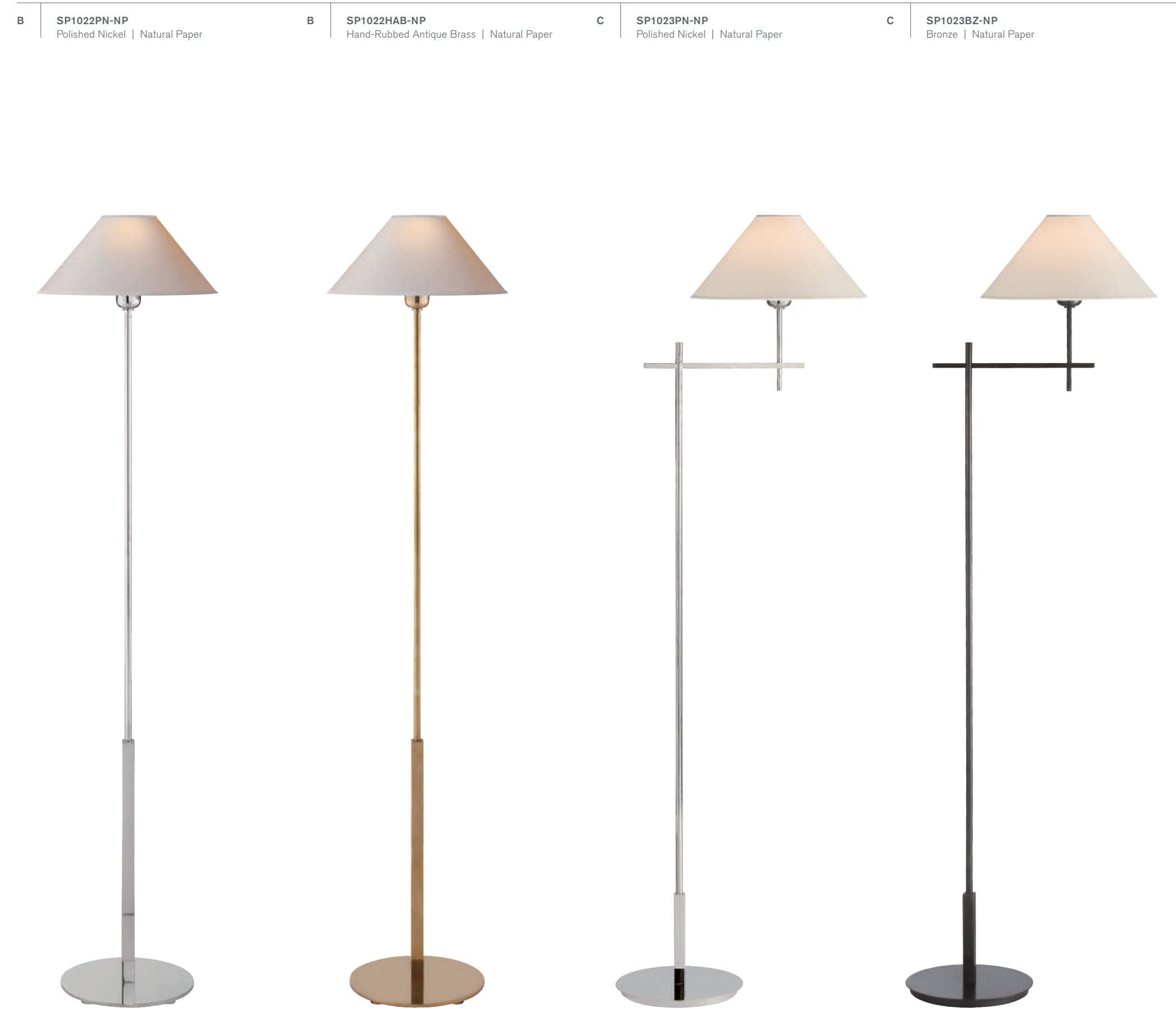

**B** **SP1022PN-NP**  
Polished Nickel | Natural Paper

**B** **SP1022HAB-NP**  
Hand-Rubbed Antique Brass | Natural Paper

**C** **SP1023PN-NP**  
Polished Nickel | Natural Paper

**C** **SP1023BZ-NP**  
Bronze | Natural Paper

<p><b>A</b>   <b>SP1504PN-NP</b> Polished Nickel   Natural Paper</p>	<p><b>A</b>   <b>SP1504BZ-NP</b> Bronze   Natural Paper</p>	<p><b>B</b>   <b>SP1505PN-NP</b> Polished Nickel   Natural Paper</p>	<p><b>B</b>   <b>SP1505BZ-NP</b> Bronze   Natural Paper</p>
--	---	--	---

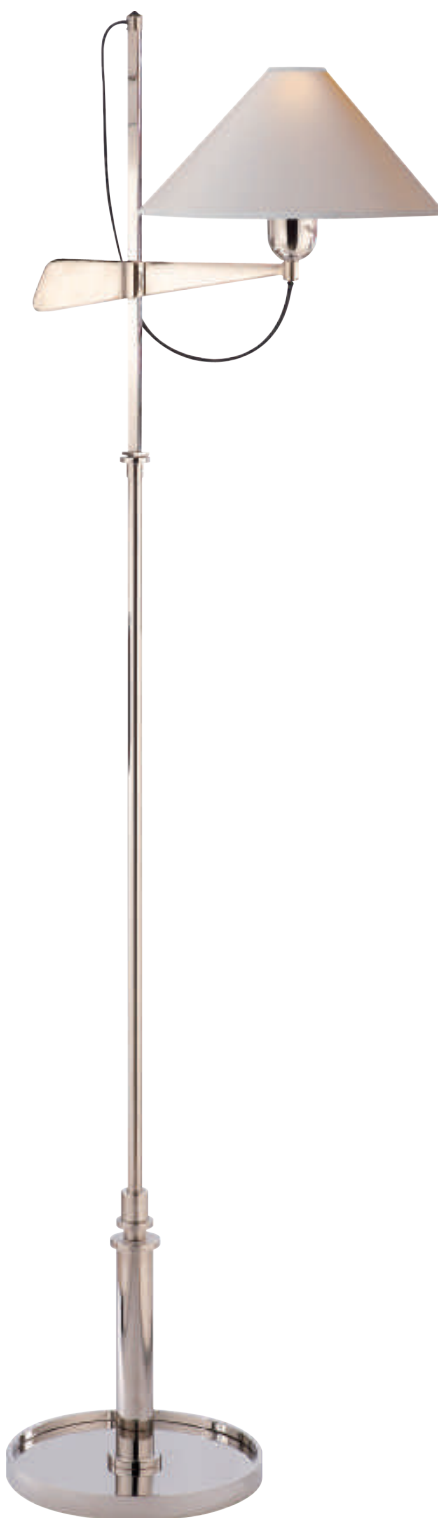

<p><b>B</b>   <b>SP1505HAB-NP</b> Hand-Rubbed Antique Brass   Natural Paper</p>
---



**A** | **HARGETT FLOOR LAMP**  
J. RANDALL POWERS

**SP1504**  
H: 39.5-53.25" | W: 12" | Base: 12" Round  
Socket: E26 Dimmer | Bulb: 60 A  
Shade: 2.5" x 11.75" x 6"  
**Additional Options:**  
Hand-Rubbed Antique Brass | Natural Paper (HAB-NP)

**B** | **HARGETT BRIDGE FLOOR LAMP**  
J. RANDALL POWERS

**SP1505**  
H: 50"- 56.5" | Ext: 15.75" | Base: 10" Round  
Socket: E26 Dimmer | Bulb: 60 A  
Shade: 2.5" x 11.75" x 7.5"





**A** **BBL1023SS-S2**  
Soft Silver | Silk Banded

**A** **BBL1023SB-S2**  
Soft Brass | Silk Banded

**A** **BBL1023BZ-S2**  
Bronze | Silk Banded

**B** **BBL1023BZ-S**  
Bronze | Silk Scalloped

opposite page

**A SIMPLE FLOOR LAMP**  
BARBARA BARRY

**BBL1023**  
H: 62.5" - 80" | W: 19" | Base: 12" Round  
Socket: E26 Dimmer | Bulb: 150 A  
Shade: 18" x 19" x 16"

**B SIMPLE FLOOR LAMP**  
BARBARA BARRY

**BBL1023**  
H: 62.5" - 80" | W: 22" | Base: 12" Round  
Socket: E26 Dimmer | Bulb: 150 A  
Shade: 20" x 22" x 17"  
**Additional Options:**  
Soft Brass | Silk Scalloped (SB-S)  
Soft Silver | Silk Scalloped (SS-S)



**C** **TOB1002PN-NP**  
Polished Nickel | Natural Paper

**C** **TOB1002AS-NP**  
Antique Silver | Natural Paper

**C** **TOB1002HAB-NP**  
Hand-Rubbed Antique Brass | Natural Paper

**C** **TOB1002BZ-NP**  
Bronze | Natural Paper

**C BRYANT FLOOR LAMP**  
THOMAS O'BRIEN

**TOB1002**  
H: 44" - 60" | W: 12" | Base: 10.5" Round  
Socket: E26 Hi-Lo | Bulb: 150 A  
Shade: 11" x 12" x 12"



**A** **TOB1153HAB-NP**  
Hand-Rubbed Antique Brass | Natural Paper

**A** **TOB1153BZ/HAB-NP**  
Bronze | Brass | Natural Paper

**B** **ARN1001HAB-L**  
Hand-Rubbed Antique Brass | Mahogany | Linen

**B** **ARN1001AI-L**  
Aged Iron | Gild | Linen

opposite page

**A** **CARON FLOOR LAMP**  
THOMAS O'BRIEN  
  
**TOB1153**  
H: 67.5" | W: 16" | Base: 18" X-Shape  
Socket: 2 - E26 Pull Chain | Bulb: 2 - 60 A  
Shade: 16" x 16" x 17" Closed Top  
**Additional Options:**  
Polished Nickel | Natural Paper (PN-NP)

**B** **FRANKFORT FLOOR LAMP**  
AERIN  
  
**ARN1001**  
H: 60" | W: 18" | Base: 18" Tripod  
Socket: E26 Keyless | Bulb: 100 A  
Shade: 10.5" x 11.5" x 25"  
\* Foot Switch

**C** **GRENOL FLOOR LAMP**  
STUDIO VC  
  
**S1177**  
H: 53" | W: 14.5" | Base: 13.25" Square  
Socket: E26 Dimmer | Bulb: 6 LED B  
Shade: 2.75" x 14.5" x 8"



**C** **S1177PN-PL**  
Polished Nickel | Natural Percalé

**C** **S1177HAB-PL**  
Hand-Rubbed Antique Brass | Natural Percalé

**C** **S1177BZ-PL**  
Bronze | Natural Percalé

<b>A</b>	<b>TOB1021PN-NP</b> Polished Nickel   Natural Paper	<b>A</b>	<b>TOB1021AI-NP</b> Aged Iron   Natural Paper	<b>A</b>	<b>TOB1021GI-NP</b> Gilded Iron   Natural Paper	<b>B</b>	<b>ARN1420PN-L</b> Polished Nickel   Linen	<b>B</b>	<b>ARN1420HAB-L</b> Hand-Rubbed Antique Brass   Linen
----------	--	----------	--	----------	--	----------	---	----------	--



opposite page

**A MIA FLOOR LAMP**  
THOMAS O'BRIEN

**TOB1021**  
H: 56" | Ext: 27.5" | Base: 18.25" Tripod  
Socket: E26 Keyless | Bulb: 75 A  
Shade: 6" x 8" x 9"  
\* Line Switch

**B ALANDER FLOOR LAMP**  
AERIN

**ARN1420**  
H: 49" | W: 9" | Ext: 9" | Base: 4.5" x 9" Rec.  
Socket: E26 Dimmer | Bulb: 75 A  
Shade: 8" x 9" x 9" Square

**C SWING ARTICULATING FLOOR LAMP**  
BARBARA BARRY

**BBL1070**  
H: 54.75" | W: 13.5" | Ext: 14.25"  
Base: 11.25" Round  
Socket: E26 Keyless | Bulb: 75 A  
Shade: 13.5" x 14.25" x 12"

<b>C</b>	<b>BBL1070SS-L</b> Soft Silver   Linen	<b>C</b>	<b>BBL1070SB-L</b> Soft Brass   Linen	<b>C</b>	<b>BBL1070BZ-L</b> Bronze   Linen
----------	---	----------	--	----------	--------------------------------------



**A** **TOB1012PN-NP**  
Polished Nickel | Natural Paper

**A** **TOB1012HAB-NP**  
Hand-Rubbed Antique Brass | Natural Paper

**A** **TOB1012BZ-NP**  
Bronze | Natural Paper



**A** **ZIYI PIVOTING FLOOR LAMP**  
THOMAS O'BRIEN

**TOB1012**  
H: 58" | W: 10.5" | Ext: 16.5"  
Base: 10.5" Round  
Socket: E26 Hi-Lo | Bulb: 75 A  
Shade: 7.5" x 8.5" x 11"

**B** **ANTON LARGE SWING ARM FLOOR LAMP**  
THOMAS O'BRIEN

**TOB1116**  
H: 70.5" | W: 17" | Base: 11.25" Round  
Socket: E26 On-Off | Bulb: 75 A  
Shade: 9" x 9" x 17"

**B** **TOB1116PN-L**  
Polished Nickel | Linen

**B** **TOB1116HAB-L**  
Hand-Rubbed Antique Brass | Linen

**B** **TOB1116BZ/HAB-L**  
Bronze | Hand-Rubbed Antique Brass | Linen





**A CLARKSON FLOOR LAMP**  
AERIN

**ARN1003**  
H: 58.25" | W: 12" | Base: 8" x 11" Oval  
Socket: 2 - E12 Candelabra | Bulb: 2 - 40 B  
Shade: 4.5" x 5.75" x 7.5"  
\* Floor Switch

**B CLARKSON TRIPLE FLOOR LAMP**  
AERIN

**ARN1034**  
H: 62.5" | W: 22.25" | Base: 8.25" Round  
Socket: 6 - E12 Candelabra | Bulb: 6 - 60 B  
Shade: 4.5" x 5.75" x 7.5"  
\* Floor Switch

**A** | **ARN1003HAB-L**  
Hand-Rubbed Antique Brass | Linen

**A** | **ARN1003HAB-L**  
Hand-Rubbed Antique Brass | Linen

**A** | **ARN1003BLK-L**  
Black | Brass | Linen

**B** | **ARN1034HAB-L**  
Hand-Rubbed Antique Brass | Linen

**B** | **ARN1034BLK-L**  
Black | Brass | Linen



<p><b>A</b>   <b>ARN1101PN-PRC</b> Polished Nickel   Stitched Parchment</p>	<p><b>A</b>   <b>ARN1101HAB-PRC</b> Hand-Rubbed Antique Brass   Stitched Parchment</p>	<p><b>B</b>   <b>TOB1004PN-WP/ST</b> Polished Nickel   White Paper   Silver Tape</p>	<p><b>B</b>   <b>TOB1004BZ-NP/BT</b> Bronze   Natural Paper   Black Tape</p>
---	--	--	--



**A ARPONT FLOOR LAMP**  
AERIN

**ARN1101**  
H: 57.25" | W: 15.75" | Ext: 16"  
Base: 17" Square  
Socket: 2 - E26 Keyless | Bulb: 2 - 60 T  
Shade: 5.5" x 7.5" x 12"  
\* Foot Switch

**B HUDSON FLOOR LAMP**  
THOMAS O'BRIEN

**TOB1004**  
H: 60" | W: 22" | Ext: 25" | Base: 16" U-Shaped  
Socket: 2 - E26 Pull Chain | Bulb: 2 - 60 A  
Shade: 22" x 22" x 6.5"  
**Additional Options:**  
Antique Nickel | White Paper | Silver Tape (AN-WP/ST)

<p><b>B</b>   <b>TOB1004HAB-NP/BT</b> Hand-Rubbed Antique Brass   Natural Paper   Black Tape</p>
--



A TOB1201PN-NP  
Polished Nickel | Natural Paper

A TOB1201HAB-NP  
Hand-Rubbed Antique Brass | Natural Paper

A TOB1201BZ-NP  
Bronze | Natural Paper



A PAULO SWING ARM FLOOR LAMP  
THOMAS O'BRIEN

**TOB1201**  
H: 63.5" | W: 16" | Base: 13" Round  
Socket: E26 Dimmer | Bulb: 150 A  
Shade: 12" x 16" x 12"

B S1026BR-NP  
Blackened Rust | Natural Paper



B GEORGETOWN BRIDGE FLOOR LAMP  
IAN K. FOWLER

**S1026**  
H: 59" - 72" | W: 12.5" | Ext: 18" | Base: 10" Round  
Socket: E26 Dimmer | Bulb: 150 A  
Shade: 9" x 12.5" x 9.5"



**A** **CHA9121AB-S**  
Antique-Burnished Brass | Silk

**A** **CHA9121AB-B**  
Antique-Burnished Brass | Black

**B** **S1200HAB-L**  
Hand-Rubbed Antique Brass | Linen

**B** **S1200HAB-NP**  
Hand-Rubbed Antique Brass | Natural Paper

opposite page

**A** **DORCHESTER SWING ARM FLOOR LAMP**  
E. F. CHAPMAN

**CHA9121**  
H: 51" - 64" | Ext: 21" | Base: 9" Round  
Socket: E26 Hi-Lo | Bulb: 75 A  
Shade: 6" x 12" x 8.5"  
©EFC DESIGNS

**B** **TRIPLE SWING ARM FLOOR LAMP**  
STUDIO VC

**S1200**  
H: 47" - 71" | W: 11" | Ext: 22" | Base: 10" Round  
Socket: E26 Dimmer | Bulb: 100 A  
Shade: 7" x 11" x 8.5"

**C** **CHA9125AB-S**  
Antique-Burnished Brass | Silk Pleat

**D** **CHA9124AB-NP**  
Antique-Burnished Brass | Natural Paper

**D** **CHA9124AB-B**  
Antique-Burnished Brass | Black



**C** **OVERSEAS ADJUSTABLE CLUB TRAY FLOOR LAMP**  
E. F. CHAPMAN

**CHA9125**  
H: 40" - 65" | W: 15" | Base: 9" Round  
Socket: 2 - E26 Pull Chain | Bulb: 2 - 60 A  
Shade: 9" x 15" x 9"  
\* Tray Height: 29"  
©EFC DESIGNS

**D** **OVERSEAS ADJUSTABLE CLUB FLOOR LAMP**  
E. F. CHAPMAN

**CHA9124**  
H: 47" - 64.5" | W: 15" | Base: 9" Round  
Socket: 2 - E26 Pull Chain | Bulb: 2 - 60 A  
Shade: 9" x 15" x 9"  
©EFC DESIGNS





**A** | **BBL1018WA-S**  
Walnut | Silk

**A** | **OCTAGON FLOOR LAMP**  
BARBARA BARRY

**BBL1018**  
H: 66" | W: 18" | Base: 12" Square  
Socket: E26 Dimmer | Bulb: 150 A  
Shade: 17" x 18" x 14.75"

**B** | **S111BW-NP**  
Belgian White | Natural Paper

**B** | **S111BB-NP**  
Bamboo | Natural Paper

**C** | **SL1700FW-NP**  
French Wax | Natural Paper

**C** | **SL1700TB-NP**  
Tudor Brown | Natural Paper

opposite page

**B** | **BAMBOO FLOOR LAMP**  
STUDIO VC

**S111**  
H: 52.5" | W: 17" | Base: 9.5" Round  
Socket: E26 Hi-Lo | Bulb: 150 A  
Shade: 13" x 17" x 12"

**C** | **TRIPOD FLOOR LAMP**  
E. F. CHAPMAN

**SL1700**  
H: 61" | W: 21" | Base: 21" Tripod  
Socket: E26 Hi-Lo | Bulb: 150 A  
Shade: 20" x 20" x 11"  
©EFC DESIGNS





FLOOR | FUNCTIONAL

A | ARN1009HAB-WHT  
Hand-Rubbed Antique Brass | White



**A | SOMMERARD TRIPLE ARM FLOOR LAMP**  
AERIN

**ARN1009**  
H: 60" - 82" | Ext: 20 - 40" | Base: 22" Tripod  
Socket: 3 - E26 Keyless | Bulb: 3 - 60A  
Shade: 7.5" x 9.5"  
\* Foot Switch

**B | SOMMERARD FLOOR LAMP**  
AERIN

**ARN1007**  
H: 36.5" - 52" | W: 21" | Ext: 20"  
Base: 21" Tripod  
Socket: E26 Keyless | Bulb: 60 A  
Shade: 7.5" x 9.5"  
\* Foot Switch

A | ARN1009HAB-BLK  
Hand-Rubbed Antique Brass | Black



B | ARN1007HAB-WHT  
Hand-Rubbed Antique Brass | White



B | ARN1007HAB-HAB  
Hand-Rubbed Antique Brass



B | ARN1007HAB-BLK  
Hand-Rubbed Antique Brass | Black





A | ARN1010HAB-HAB  
Hand-Rubbed Antique Brass

A | CLEMENTE FLOOR LAMP  
AERIN

ARN1010  
H: 47.25" - 59.25" | W: 10.5" | Ext: 17.5"  
Base: 10.5" Round  
Socket: E26 Keyless | Bulb: 60 A  
\* Foot Switch

B | AUSTEN LARGE DUAL FUNCTION FLOOR LAMP  
AERIN

ARN1712  
H: 70.25" | W: 14" | Ext: 23"  
Base: 14" Round  
Socket: 2 - E26 On-Off | Bulb: 2 - 40 A

A | ARN1010HAB-WHT  
Hand-Rubbed Antique Brass | White

A | ARN1010HAB-BLK  
Hand-Rubbed Antique Brass | Black

B | ARN1712WHT  
White

B | ARN1712BLK  
Black



A | **ARN1501HAB-WHT**  
Hand-Rubbed Antique Brass | White

A | **ARN1501HAB-BLK**  
Hand-Rubbed Antique Brass | Black

B | **ARN1006WHT**  
White | Brass

B | **ARN1006BLK**  
Black

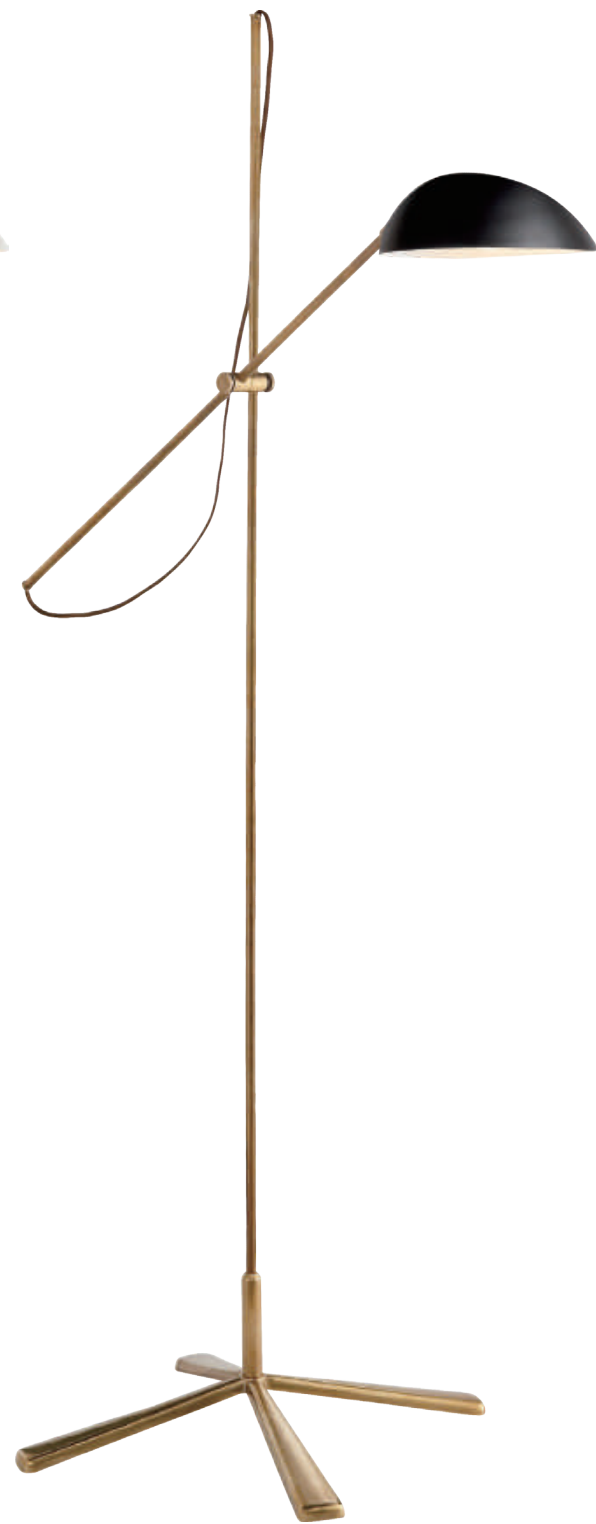
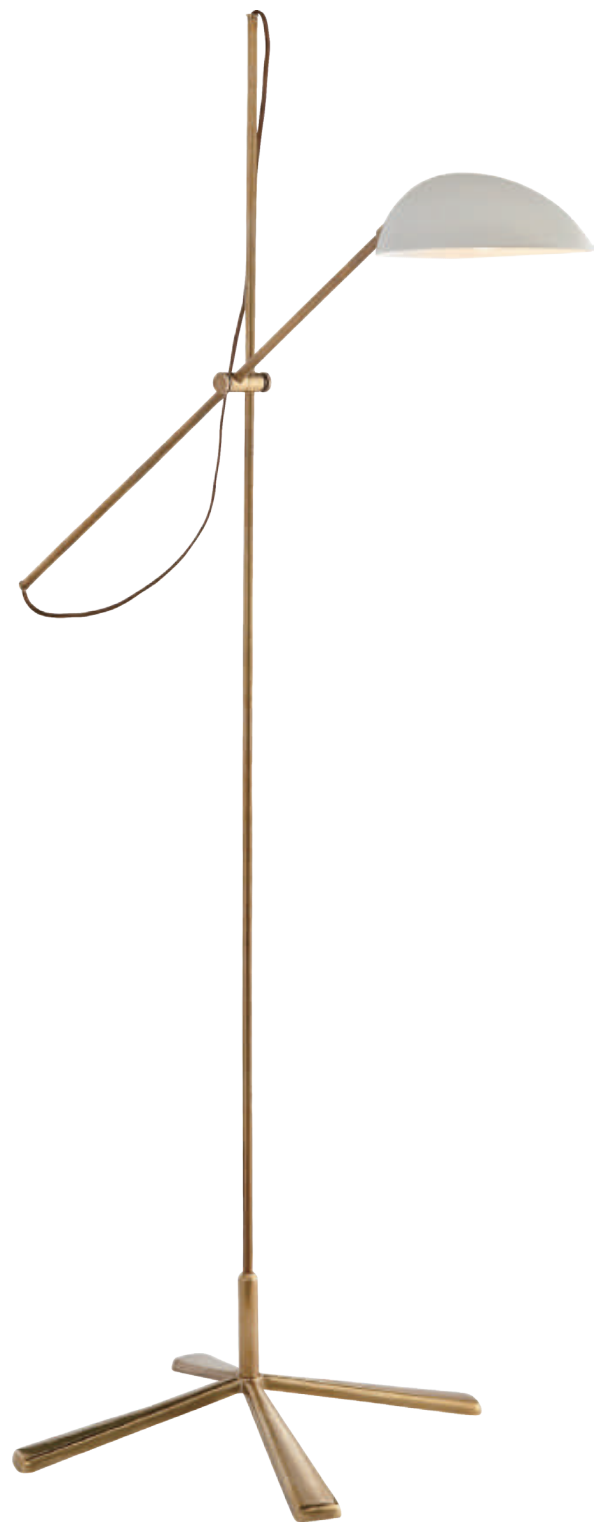

**A GRAPHIC FLOOR LAMP**  
AERIN

**ARN1501**  
H: 67" | W: 44" | Base: 23" Round  
Socket: E26 Keyless | Bulb: 60 A  
\* Foot Switch

**B CHARLTON FLOOR LAMP**  
AERIN

**ARN1006**  
H: 51" - 63" | W: 12" | Ext: 42"  
Base: 12" Round  
Socket: E26 Keyless | Bulb: 60 A  
\* Floor Switch

<p><b>A</b>   <b>ARN1013HAB-WHT</b> Hand-Rubbed Antique Brass   White</p>	<p><b>A</b>   <b>ARN1013HAB-BLK</b> Hand-Rubbed Antique Brass   Black</p>	<p><b>B</b>   <b>ARN1014HAB-WHT</b> Hand-Rubbed Antique Brass   White</p>	<p><b>B</b>   <b>ARN1014HAB-HAB</b> Hand-Rubbed Antique Brass</p>
---	---	---	---



**A** | **MAYOTTE LARGE OFFSET FLOOR LAMP**  
AERIN

**ARN1013**  
H: 55.25" | W: 16" | Ext: 21.75"  
Base: 16" Triangle  
Socket: E26 Foot Switch | Bulb: 60 A

**B** | **MORESBY FLOOR LAMP**  
AERIN

**ARN1014**  
H: 56" | W: 13" | Ext: 23"  
Base: 18.75" Tripod  
Socket: E26 Dimmer | Bulb: 60 A

**B** | **ARN1014HAB-HAB**  
Hand-Rubbed Antique Brass



A TOB1231HAB-BLK  
Hand-Rubbed Antique Brass | Black



A ANTONIO FLOOR LAMP  
THOMAS O'BRIEN

**TOB1231**  
H: 43" - 60" | W: 14.5" | Ext: 14.5" - 26"  
Base: 14.5" Round  
Socket: E26 On-Off | Bulb: 75 A

B ANTONIO ARTICULATING EASEL FLOOR LAMP  
THOMAS O'BRIEN

**TOB1232**  
H: 76" - 82" | W: 26" | Base: 26" Round  
Socket: E26 In-Line Switch | Bulb: 40 A  
**Additional Options:**  
Hand-Rubbed Antique Brass | Matte Black (HAB-BLK)

A TOB1231PN-AW  
Polished Nickel | Antique White

A TOB1231HAB-AW  
Hand-Rubbed Antique Brass | Antique White

B TOB1232PN-AW  
Polished Nickel | Antique White

B TOB1232HAB-AW  
Hand-Rubbed Antique Brass | Antique White



A **KW1611PN/BM**  
Polished Nickel | Black Marble



A **KW1611AB/WM**  
Antique-Burnished Brass | White Marble



opposite page

A **ALMA FLOOR LAMP**  
KELLY WEARSTLER

**KW1611**  
H: 41.5" - 52.5" | W: 7.5" | Ext: 15.5"  
Base: 7.5" Round  
Socket: E17 Keyless | Bulb: 4.5W LED R14  
\* Floor Switch

B **KW1088BZ/AB**  
Bronze | Brass | Antique White | Gild Interior

B **KW1088BZ/AB-BLK**  
Bronze | Brass | Black | Gild Interior



B **CLEO FLOOR LAMP**  
KELLY WEARSTLER

**KW1088**  
H: 60" | W: 29.25" | Base: 10" Square  
Socket: E26 Keyless | Bulb: 100 A  
\* Line Switch



**A** | **S1260AI-HAB**  
Aged Iron | Hand-Rubbed Antique Brass



**A** | **S1260AI-HAB**  
Aged Iron | Hand-Rubbed Antique Brass



**A** | **LOLA MEDIUM PHARMACY FLOOR LAMP**  
IAN K. FOWLER

**S1260**  
H: 40" - 48" | H: 47.75" | W: 16"  
Base: 16" T-Shape  
Socket: E26 Dimmer | Bulb: 40 T

**B** | **AUSTIN ADJUSTABLE FLOOR LAMP**  
IAN K. FOWLER

**S1350**  
H: 36.75" - 48" | W: 11" | Ext: 24.5"  
Base: 11" Round | LED: 8w  
\* Dimmer on Cord

**B** | **S1350PN**  
Polished Nickel

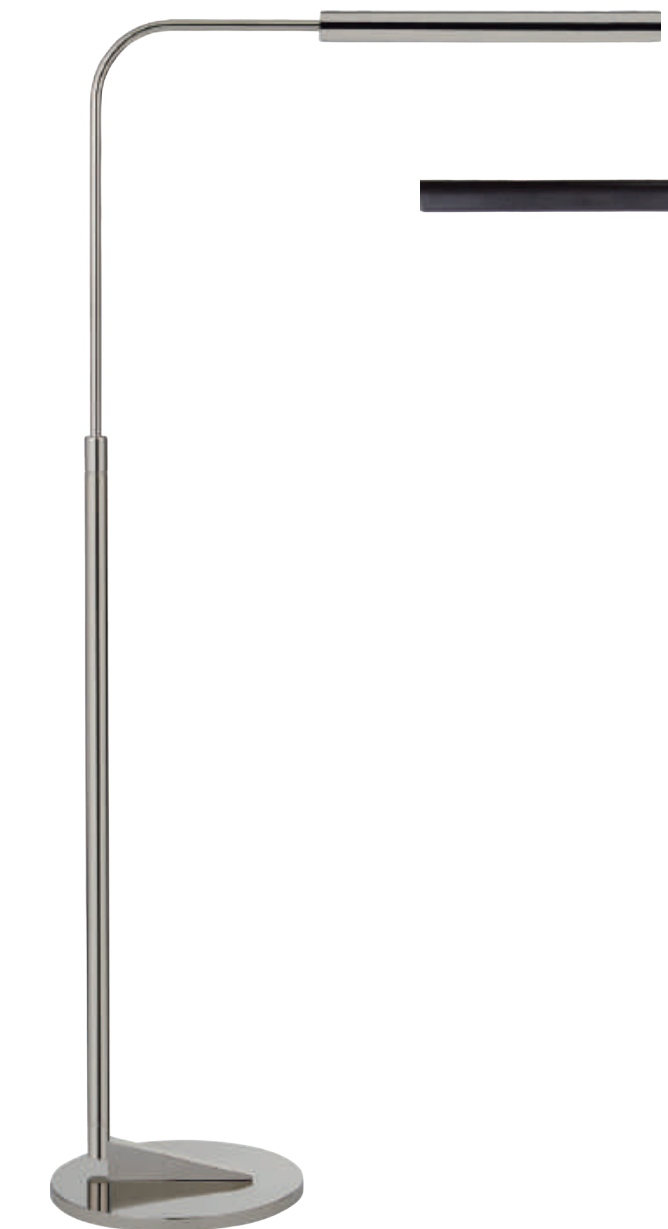

**B** | **S1350AI**  
Aged Iron



A	<b>ARN1042PN</b> Polished Nickel	A	<b>ARN1042HAB</b> Hand-Rubbed Antique Brass	B	<b>KW1420PN</b> Polished Nickel	B	<b>KW1420AB</b> Antique-Burnished Brass
---	-------------------------------------	---	--	---	------------------------------------	---	--



opposite page

**A LANCELOT PIVOTING FLOOR LAMP**  
AERIN

**ARN1042**  
H: 48.5" | W: 10" | Ext: 10.75"  
Base: 10" Round  
Socket: E17 In-Line Switch | Bulb: 4.5W LED R14

**B LUCIEN ADJUSTABLE FLOOR LAMP**  
KELLY WEARSTLER

**KW1420**  
H: 42.5" | W: 12" | Ext: 23.5"  
Base: 12" Round  
Socket: E26 Keyless | Bulb: 25 T

C	<b>KW1240AB-WG</b> Antique-Burnished Brass   White Glass	C	<b>KW1240PN-PN</b> Polished Nickel   Polished Nickel	C	<b>KW1240AB-AB</b> Antique-Burnished Brass
---	---	---	---	---	---



**C DULCET MEDIUM PHARMACY FLOOR LAMP**  
KELLY WEARSTLER

**KW1240**  
H: 43.5" - 54.5" | W: 15" | Ext: 17.25"  
Base: 15" Round  
Socket: E26 Foot Switch | Bulb: 60 A  
**Additional Options:**  
Bronze | Bronze (BZ-BZ)  
Bronze | White Glass (BZ-WG)  
Polished Nickel | White Glass (PN-WG)

A **KW1410PN-FG**  
Polished Nickel | Frosted Glass

A **KW1410AB-FG**  
Antique-Burnished Brass | Frosted Glass

A **KW1410BZ/AB-FG**  
Bronze | Antique-Burnished Brass | Frosted Glass

B **KW1062PN-WG**  
Polished Nickel | White Glass

B **KW1062AB-WG**  
Antique-Burnished Brass | White Glass

B **KW1062BZ-WG**  
Bronze | White Glass



A **LARCHMONT FLOOR LAMP**  
KELLY WEARSTLER

**KW1410**  
H: 50" | W: 10" | Base: 10" x 14.5" Rec.  
Socket: E26 Keyless | Bulb: 60 B  
\* Dimmer in Pole



B **PRECISION PHARMACY FLOOR LAMP**  
KELLY WEARSTLER

**KW1062**  
H: 39.5" - 47.5" | W: 6" | Ext: 17"  
Base: 6" x 11" Rec.  
Socket: E17 Keyless | Bulb: 6w LED T  
\* In Line Dimmer  
\* Bulb Included

**A** **KW1585AB-EC**  
Antique-Burnished Brass | Etched Crystal

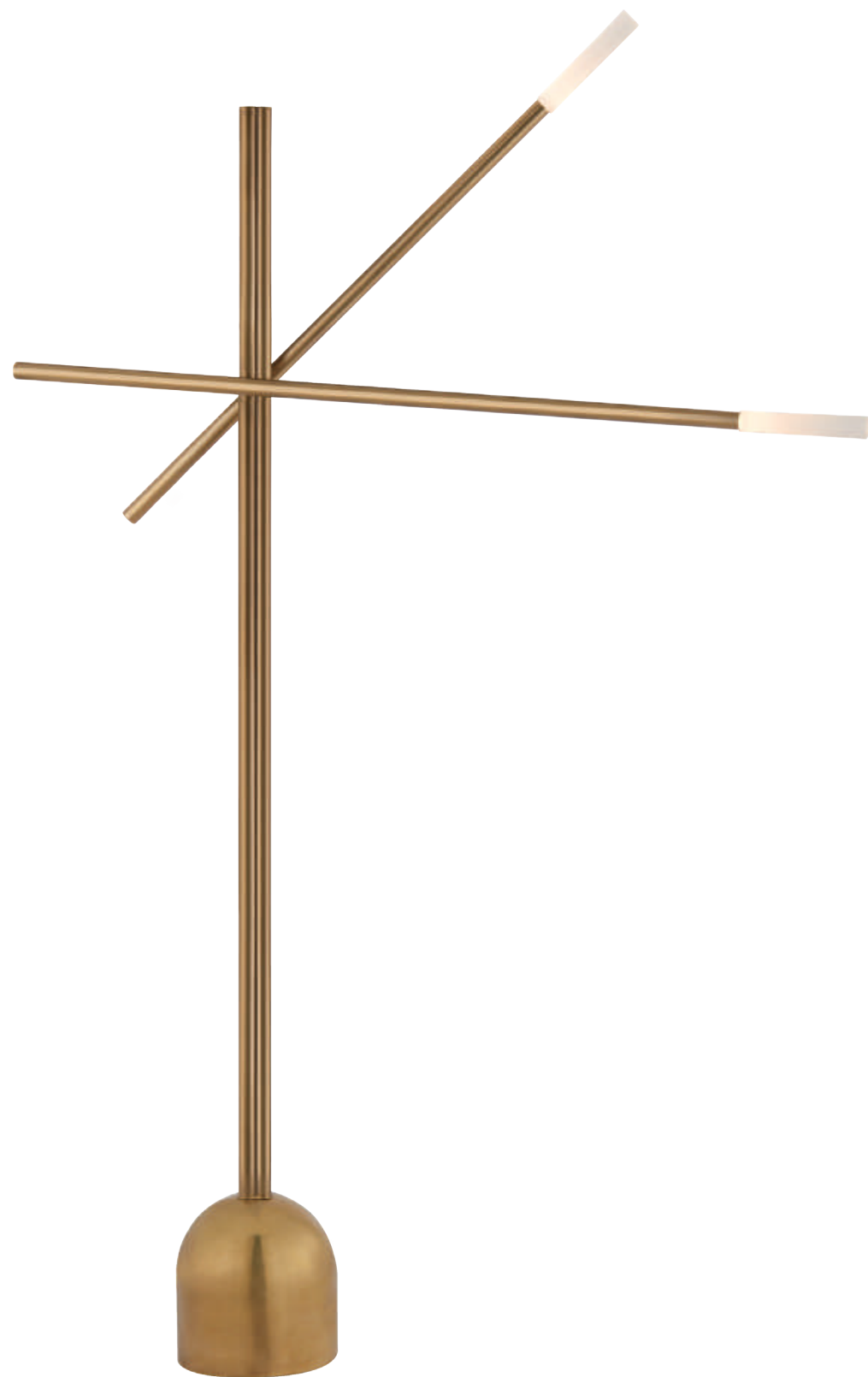

**A** **KW1585BZ-EC**  
Bronze | Etched Crystal

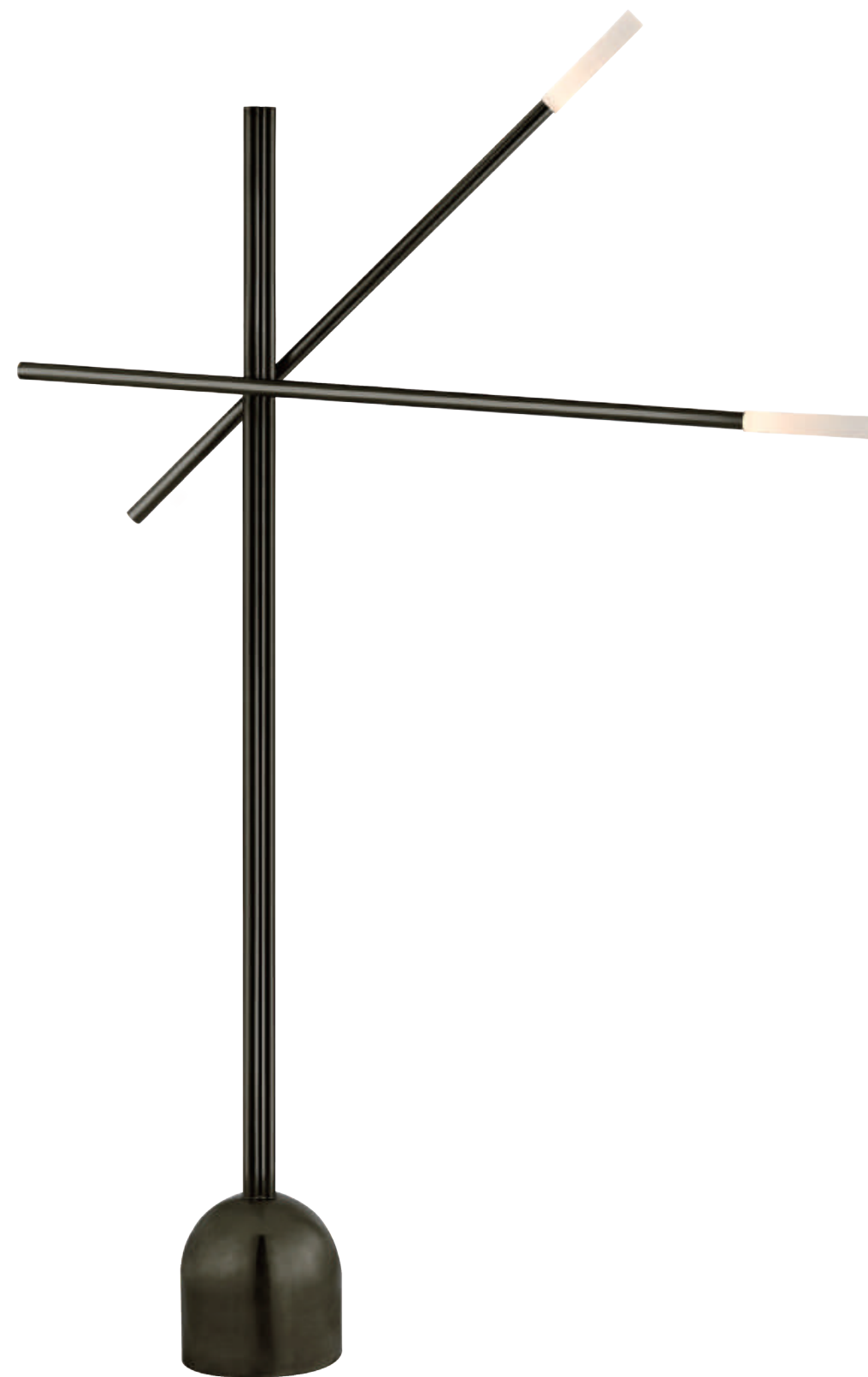

opposite page

**A** **ROUSSEAU DOUBLE BOOM ARM FLOOR LAMP**  
KELLY WEARSTLER

**KW1585**  
H: 78" - 88.5" | W: 10" | Ext: 45.5" - 53"  
Base: 10" Round | LED: 8w  
**Additional Options:**  
Polished Nickel | Etched Crystal (PN-EC)  
\* In Line Dimmer

**B** **PB1005PN**  
Polished Nickel

**B** **PB1005NB**  
Natural Brass

**B** **PB1005MBK**  
Matte Black

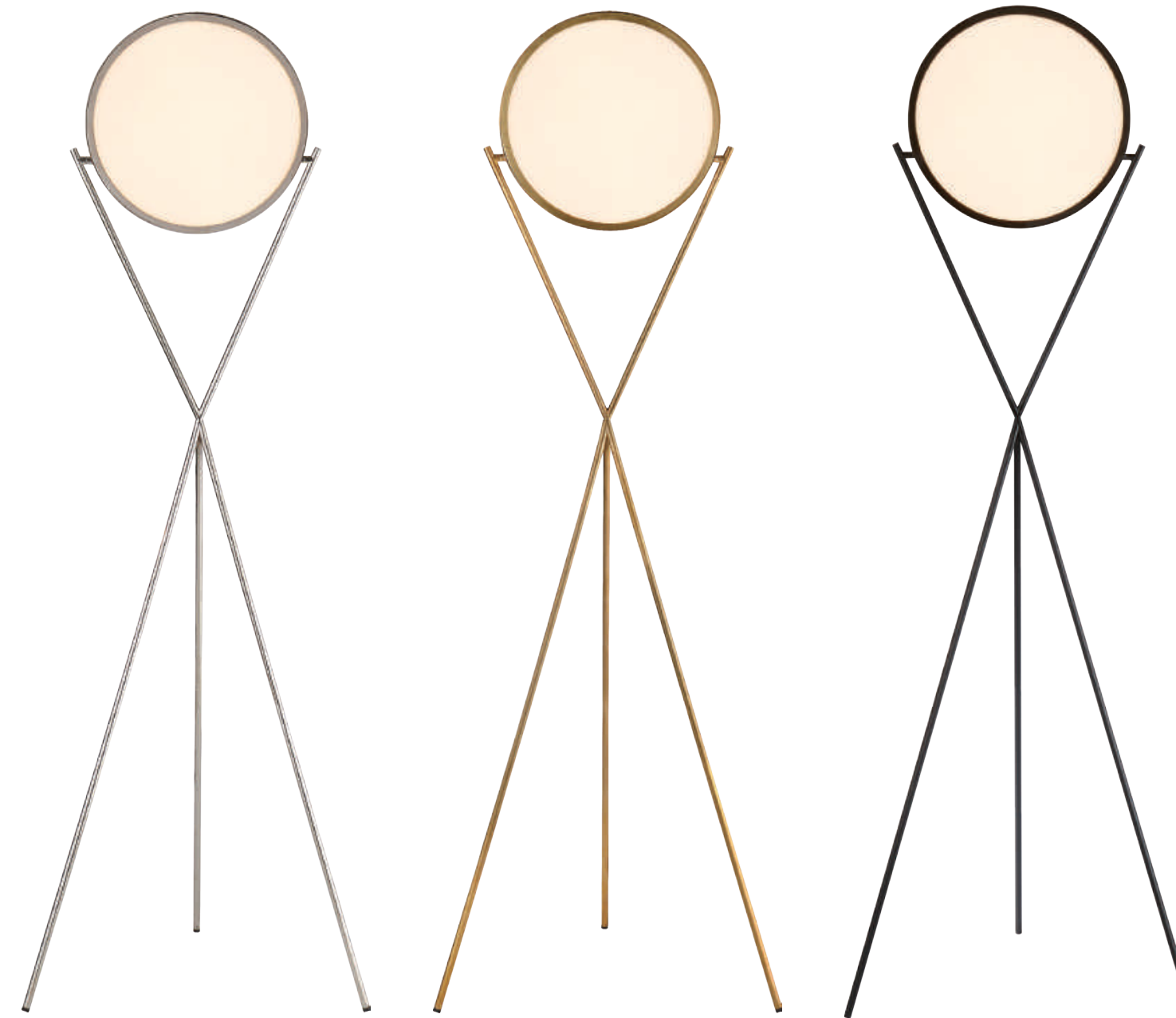

**B** **DOT STANCE 13" ROTATING FLOOR LAMP**  
PETER BRISTOL

**PB1005**  
H: 61" | W: 18.5" | Base: 18" x 19.5" Tripod  
LED: 18w  
\* Dimmer on Cord

A

**TOB1292PN-L**  
Polished Nickel | Linen



A

**TOB1292BZ/HAB-L**  
Bronze | Hand-Rubbed Antique Brass | Linen



opposite page

**A OSIRIS TRIPOD REFLECTOR FLOOR LIGHT**  
THOMAS O'BRIEN

**TOB1292**  
H: 75" - 81.75" | W: 39.25" - 43.5" | Ext: 34" - 39"  
Base: 41" x 36.5" Tripod  
Socket: E26 Dimmer | Bulb: 75 A

B

**TOB1290PN-L**  
Polished Nickel | Linen

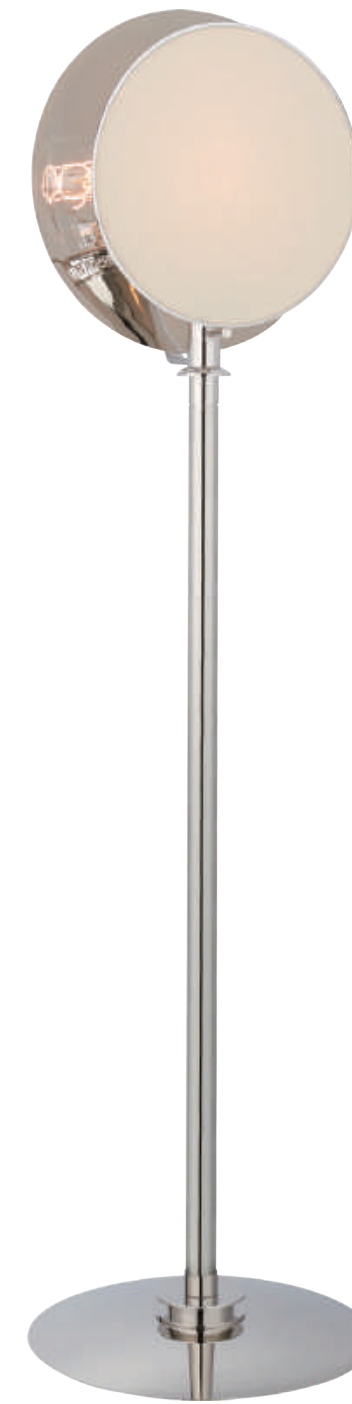

B

**TOB1290HAB-L**  
Hand-Rubbed Antique Brass | Linen

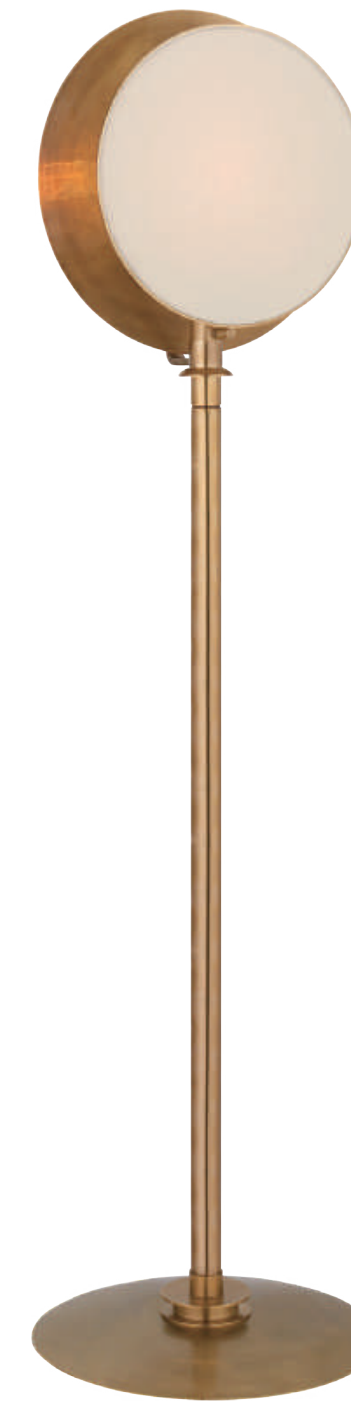

B

**TOB1290BZ/HAB-L**  
Bronze | Hand-Rubbed Antique Brass | Linen

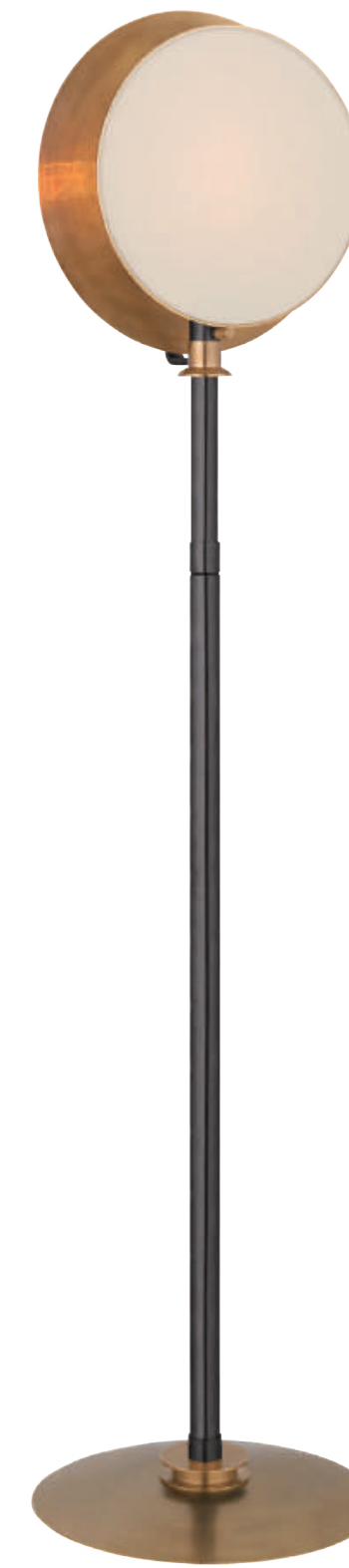

**B OSIRIS LARGE REFLECTOR FLOOR LIGHT**  
THOMAS O'BRIEN

**TOB1290**  
H: 60" - 73" | W: 15.25" | Base: 15.5" Round  
Socket: E26 On/Off | Bulb: 60 A

**A** **TOB1010PN-NP2**  
Polished Nickel | Small Natural Paper



**B** **TOB1010HAB-NP**  
Hand-Rubbed Antique Brass | Natural Paper



**B** **TOB1010BZ-NP**  
Bronze | Natural Paper



**B** **TOB1010HAB-NP**  
Hand-Rubbed Antique Brass | Natural Paper



**A** **STUDIO FLOOR LAMP**  
THOMAS O'BRIEN

**TOB1010**  
H: 53.5" - 83" | W: 20" | Base: 9.5" x 34.5" Tripod  
Socket: 2 - E26 Pull Chain | Bulb: 2 - 75 A  
Shade: 17" x 20" x 17"  
**Additional Options:**  
Bronze | Small Natural Paper (BZ-NP2)  
Antique Brass | Small Natural Paper (HAB-NP2)

**B** **STUDIO FLOOR LAMP**  
THOMAS O'BRIEN

**TOB1010**  
H: 53.5" - 83" | W: 28" | Base: 9.5" x 34.5" Tripod  
Socket: 2 - E26 Pull Chain | Bulb: 2 - 75 A  
Shade: 25" x 28" x 22"  
**Additional Options:**  
Polished Nickel | Natural Paper (PN-NP)

A TOB1200BZ  
Bronze



**A PASK PHARMACY FLOOR LAMP**  
THOMAS O'BRIEN

**TOB1200**  
H: 37.5"- 59.5" | Ext: 16.5"  
Base: 6" x 9" Rec.  
Socket: E26 Dimmer | Bulb: 60 T

**B DORCHESTER PHARMACY FLOOR LAMP**  
E. F. CHAPMAN

**CHA9107**  
H: 37"- 63" | Ext: 22" | Base: 9" Round  
Socket: E26 Hi-Lo | Bulb: 40 T  
Shade: 8.75" x 3.5" x 2"  
**Additional Options:**  
Antique Nickel (AN)  
©EFC DESIGNS

A TOB1200PN  
Polished Nickel

A TOB1200HAB  
Hand-Rubbed Antique Brass

B CHA9107PN  
Polished Nickel

B CHA9107AB  
Antique-Burnished Brass





A | **SP1508HAB**  
Hand-Rubbed Antique Brass

A | **WILLIAM PHARMACY FLOOR LAMP**  
J. RANDALL POWERS

**SP1508**  
H: 36.25" - 41.25" | W: 11"  
Ext: 15" | Base: 11" x 13.5"  
Socket: E26 Dimmer | Bulb: 40 T

B | **ETON SMALL PHARMACY FLOOR LAMP**  
THOMAS O'BRIEN

**TOB1102**  
H: 34" - 46" | W: 9" | Base: 9" Square  
Socket: E26 Dimmer | Bulb: 40 T  
**Additional Options:**  
Bronze | Black Marble (BZ/BM)  
Polished Nickel | Black Marble (PN/BM)

A | **SP1508PN**  
Polished Nickel

A | **SP1508BZ**  
Bronze

B | **TOB1102HAB/WM**  
Hand-Rubbed Antique Brass | White Marble

B | **TOB1102BZ/ALB**  
Bronze | Alabaster





A	<b>81134PN</b> Polished Nickel	A	<b>81134HAB</b> Hand-Rubbed Antique Brass	A	<b>81134BZ</b> Bronze	B	<b>91025PN</b> Polished Nickel	B	<b>91025HAB</b> Hand-Rubbed Antique Brass
---	-----------------------------------	---	--	---	--------------------------	---	-----------------------------------	---	--



**A** STUDIO SWING ARM FLOOR LAMP  
STUDIO VC

**81134**  
H: 43" - 57" | Ext: 20" | Base: 6" x 9" Rec.  
Socket: E26 Dimmer | Bulb: 40 J  
**Additional Options:**  
Antique Nickel (AN)  
\* Bulb Included

**B** STUDIO PHARMACY FLOOR LAMP  
STUDIO VC

**91025**  
H: 34" - 45" | Ext: 13" | Base: 6" x 9" Rec.  
Socket: E26 Dimmer | Bulb: 60 T  
**Additional Options:**  
Antique Nickel (AN)

A	<b>S1100PN</b> Polished Nickel	A	<b>S1100BZ</b> Bronze	B	<b>CHA9161AB</b> Antique-Burnished Brass	B	<b>CHA9161BZ</b> Bronze
---	-----------------------------------	---	--------------------------	---	---	---	----------------------------



opposite page

**A OLD PHARMACY FLOOR LAMP**  
STUDIO VC

**S1100**  
H: 36" - 54" | Ext: 15" | Base: 10" Round  
Socket: E26 On-Off | Bulb: 60 A  
Shade: 6" Round  
**Additional Options:**  
Antique Nickel (AN)  
Hand-Rubbed Antique Brass (HAB)

**B APOTHECARY FLOOR LAMP**  
E. F. CHAPMAN

**CHA9161**  
H: 40" - 54" | Ext: 18" | Base: 10" Round  
Socket: E26 Hi-Lo | Bulb: 60 A  
**Additional Options:**  
Antique Nickel (AN)  
Polished Nickel (PN)  
Sheffield Nickel (SN)  
©EFC DESIGNS

**C STUDIO PIVOTING FLOOR LAMP**  
THOMAS O'BRIEN

**TOB1015**  
H: 43.5" - 86" | Ext: 53" | Base: 20" Tripod  
Socket: E26 Keyless | Bulb: 75 A  
**Additional Options:**  
Antique Nickel (AN)  
\* Floor Dimmer

C	<b>TOB1015PN</b> Polished Nickel	C	<b>TOB1015HAB</b> Hand-Rubbed Antique Brass	C	<b>TOB1015BZ</b> Bronze
---	-------------------------------------	---	--	---	----------------------------





CEILING



CEILING | CHANDELIER



**A** | **ARN5105PN-CG**  
Polished Nickel | Crystal

**A** | **SANGER SMALL CHANDELIER**  
AERIN

**ARN5105**  
H: 19" | W: 29" | Canopy: 5.5" Round  
Socket: 12 - E12 Candelabra | Bulb: 12 - 60 C

**B** | **SANGER LARGE CHANDELIER**  
AERIN

**ARN5120**  
Fixture: 21" H | W: 36.75" | Canopy: 5.5" Round  
Socket: 18 - E12 Candelabra | Bulb: 18 - 40 C

**C** | **SANGER GRANDE CHANDELIER**  
AERIN

**ARN5121**  
H: 18.25" | W: 48" | Canopy: 5.5" Round  
Socket: 16 - E12 Candelabra | Bulb: 16 - 25 B  
\* Requires Special Assembly and Installation



**A** | **ARN5105PN-CG**  
Polished Nickel | Crystal



**B** | **ARN5120PN-CG**  
Polished Nickel | Crystal



**C** | **ARN5121PN-CG**  
Polished Nickel | Crystal



**A** | **SK5424PN-CA**  
Polished Nickel | Clear Acrylic



**A** | **SK5424PN-CA**  
Polished Nickel | Clear Acrylic



**A** | **SK5424HAB-CA**  
Hand-Rubbed Antique Brass | Clear Acrylic

opposite page

**A** | **ADELE FOUR-TIER WATERFALL CHANDELIER**  
SUZANNE KASLER

**SK5424**  
H: 24" | W: 20" | Canopy: 5" Round  
Socket: 6 - E26 Keyless | Bulb: 6 - 40 B



**B** | **SK5421PN-CA**  
Polished Nickel | Clear Acrylic



**B** | **SK5421HAB-CA**  
Hand-Rubbed Antique Brass | Clear Acrylic

**B** | **ADELE LARGE WIDE DRUM CHANDELIER**  
SUZANNE KASLER

**SK5421**  
H: 20" | W: 28.25" | Canopy: 5" Round  
Socket: 4 - E26 Keyless | Bulb: 4 - 40 B

**C** | **ADELE THREE-TIER WATERFALL CHANDELIER**  
SUZANNE KASLER

**SK5423**  
H: 36.5" | W: 24" | Canopy: 5" Round  
Socket: 12 - E12 Candelabra | Bulb: 12 - 40 C



**C** | **SK5423PN-CA**  
Polished Nickel | Clear Acrylic



**C** | **SK5423HAB-CA**  
Hand-Rubbed Antique Brass | Clear Acrylic

**A BONNINGTON SMALL CHANDELIER**  
AERIN  
  
**ARN5124**  
H: 15.25" | W: 24.25" | Canopy: 6" Oct.  
Socket: 12 - E12 Candelabra | Bulb: 12 - 60 C

**B BONNINGTON SMALL PENDANT**  
AERIN  
  
**ARN5123**  
H: 14.25" | W: 6.5" | Canopy: 6" Oct.  
Socket: E26 Keyless | Bulb: 40 A

**C BONNINGTON TALL CHANDELIER**  
AERIN  
  
**ARN5128**  
H: 26.5" | W: 16" | Canopy: 6" Oct.  
Socket: 14 - E12 Candelabra | Bulb: 14 - 40 C

**D BONNINGTON LARGE CHANDELIER**  
AERIN  
  
**ARN5125**  
H: 15.25" | W: 32" | Canopy: 6" Oct.  
Socket: 18 - E12 Candelabra | Bulb: 18 - 40 C



**A ARN5124HAB-CG**  
Hand-Rubbed Antique Brass | Crystal



**A ARN5124PN-CG**  
Polished Nickel | Crystal



**B ARN5123PN-CG**  
Polished Nickel | Crystal

**B ARN5123HAB-CG**  
Hand-Rubbed Antique Brass | Crystal

**C ARN5128PN**  
Polished Nickel

**C ARN5128HAB**  
Hand-Rubbed Antique Brass



**D ARN5125PN-CG**  
Polished Nickel | Crystal



**D ARN5125HAB-CG**  
Hand-Rubbed Antique Brass | Crystal



**A LESINA CHANDELIER**  
AERIN  
**ARN5170**  
H: 31.25" | W: 30.75" | Canopy: 6.75" Round  
Socket: 16 - E12 Candelabra | Bulb: 16 - 40 G

**B AMBROIS MEDIUM CHANDELIER**  
AERIN  
**ARN5145**  
Fixture: 25" H | W: 30.25" | Canopy: 5" Round  
Socket: 13 - E12 Candelabra | Bulb: 13 - 60 C



**C SR5114PN-CG**  
Polished Nickel | Clear Glass

**A ARN5170BSL-CG**  
Burnished Silver Leaf | Crystal

**A ARN5170G-CG**  
Gild | Crystal



**B ARN5145PN-CG**  
Polished Nickel | Crystal

**B ARN5145HAB-CG**  
Hand-Rubbed Antique Brass | Crystal

**C MIA MEDIUM BARREL CHANDELIER**  
JOHN ROSSELLI  
**SR5114**  
H: 28.75" | W: 20.75" | Canopy: 5" Round  
Socket: 12 - E12 Candelabra | Bulb: 12 - 40 C

**C SR5114HAB-CG**  
Hand-Rubbed Antique Brass | Clear Glass



**D SR5111HAB-CG**  
Hand-Rubbed Antique Brass | Clear Glass



**E SR5110HAB-CG**  
Hand-Rubbed Antique Brass | Clear Glass

**D MIA LARGE CHANDELIER**  
JOHN ROSSELLI  
**SR5111**  
Fixture: 37" H | W: 24" | Canopy: 5.75" Round  
Socket: 5 - E26 Keyless | Bulb: 5 - 40 B

**E MIA SMALL CHANDELIER**  
JOHN ROSSELLI  
**SR5110**  
Fixture: 21.75" H | W: 14" | Canopy: 5.75" Round  
Socket: 5 - E26 Keyless | Bulb: 5 - 40 A





**A** | **ARN5173PN-CG**  
Polished Nickel | Crystal



**B** | **ARN5174G-CG**  
Gild | Crystal



**C** | **JN5234BSL/CG**  
Burnished Silver Leaf | Crystal



**D** | **JN5232G/CG**  
Gild | Crystal

**A** | **LISCIA CHANDELIER**  
AERIN  
  
**ARN5173**  
H: 17.75" | W: 25" | Canopy: 5" Round  
Socket: 12 - E12 Candelabra | Bulb: 12 - 40 C  
**Additional Options:**  
Gild | Crystal (G-CG)

**B** | **LISCIA LARGE CHANDELIER**  
AERIN  
  
**ARN5174**  
H: 20.75" | W: 36" | Canopy: 5" Round  
Socket: 12 - E12 Candelabra | Bulb: 12 - 40 C  
**Additional Options:**  
Polished Nickel | Crystal (PN-CG)

**C** | **MILAZZO MEDIUM WATERFALL CHANDELIER**  
JULIE NEILL  
  
**JN5234**  
H: 20" | W: 28.5" | Canopy: 4.5" x 5.25" Hex.  
Socket: 8 - E12 Candelabra | Bulb: 8 - 40 C  
**Additional Options:**  
Gild | Crystal (G/CG)

**D** | **MILAZZO LARGE WATERFALL CHANDELIER**  
JULIE NEILL  
  
**JN5232**  
H: 27.5" | W: 35.75" | Canopy: 5.25" x 6.25" Hex.  
Socket: 12 - E12 Candelabra | Bulb: 12 - 40 C  
**Additional Options:**  
Burnished Silver Leaf | Crystal (BSL/CG)

opposite page

**E** | **BELLVALE SMALL CHANDELIER**  
AERIN

**ARN5122**  
Fixture: 14" H | W: 15.25" | Canopy: 5" Round  
Socket: 6 - E12 Candelabra | Bulb: 6 - 60 C



**E** | **ARN5122PN-CG**  
Polished Nickel | Crystal



**E** | **ARN5122HAB-CG**  
Hand-Rubbed Antique Brass | Crystal



**E** | **ARN5122HAB-CG**  
Hand-Rubbed Antique Brass | Crystal



A | ARN5102HAB-WG  
Hand-Rubbed Antique Brass | White Acrylic

**A | JACQUELINE MEDIUM CHANDELIER**  
AERIN

**ARN5102**  
H: 35" | W: 19" | Canopy: 5.25" Round  
Socket: 4 - E12 Candelabra | Bulb: 4 - 60 C

**B | JACQUELINE TWO-TIER CHANDELIER**  
AERIN

**ARN5104**  
Fixture: 38" H | W: 32.25" | Canopy: 7" Round  
Socket: 12 - E12 Candelabra | Bulb: 12 - 60 C

**Additional Options for Jacqueline:**  
Hand-Rubbed Antique Brass | Clear Glass (HAB-CG)  
Hand-Rubbed Antique Brass | White Acrylic (HAB-WG)  
Burnished Silver Leaf | White Acrylic (BSL-WG)  
Burnished Silver Leaf | Clear Glass (BSL-CG)



A | ARN5102BSL-CG  
Burnished Silver Leaf | Clear Glass

A | ARN5102HAB-CG  
Hand-Rubbed Antique Brass | Clear Glass

A | ARN5102BSL-WG  
Burnished Silver Leaf | White Acrylic

A | ARN5102HAB-WG  
Hand-Rubbed Antique Brass | White Acrylic



B | ARN5104BSL-CG  
Burnished Silver Leaf | Clear Glass

B | ARN5104HAB-CG  
Hand-Rubbed Antique Brass | Clear Glass

B | ARN5104HAB-WG  
Hand-Rubbed Antique Brass | White Acrylic



**A** **KS5065PN-CRE**  
Polished Nickel | Cream Tinted Glass

**A** **KS5065PN-BLS**  
Polished Nickel | Blush Tinted Glass

**A** **KS5065SB-CRE**  
Soft Brass | Cream Tinted Glass

**A** **KS5065SB-BLS**  
Soft Brass | Blush Tinted Glass

opposite page

**A** **LEIGHTON SMALL CHANDELIER**  
KATE SPADE NEW YORK

**KS5065**  
H: 16" | W: 13" | Canopy: 4.5" Round  
Socket: 4 - E12 Candelabra | Bulb: 4 - 60 G

**B** **LEIGHTON MEDIUM CASCADING CHANDELIER**  
KATE SPADE NEW YORK

**KS5060**  
H: 27" | W: 24.5" | Canopy: 4.5" Round  
Socket: 5 - E12 Candelabra | Bulb: 5 - 60 B  
**Additional Options:**  
Polished Nickel | Blush Tinted Glass (PN-BLS)



**C** **JN5015BSL-CG**  
Burnished Silver Leaf | Crystal Trim

**C** **JN5015G-CG**  
Gild | Crystal Trim



**B** **KS5060PN-CRE**  
Polished Nickel | Cream Tinted Glass

**B** **KS5060SB-CRE**  
Soft Brass | Cream Tinted Glass

**B** **KS5060SB-BLS**  
Soft Brass | Blush Tinted Glass

**C** **ASPRA MEDIUM CHANDELIER**  
JULIE NEILL

**JN5015**  
H: 43" | W: 30" | Canopy: 5" Round  
Socket: 6 - E12 Candelabra | Bulb: 6 - 40 B

**D** **CLARET SHORT CHANDELIER**  
AERIN

**ARN5220**  
H: 21.5" | W: 27.5" | Canopy: 6" Decorative  
Socket: 12 - E12 Candelabra | Bulb: 12 - 40 C



**D** **ARN5220BSL-CG**  
Burnished Silver Leaf | Crystal

**D** **ARN5220G-CG**  
Gild | Crystal



**A** | **NW5051GI**  
Gilded Iron | Clear Glass

**A** | **CALAIS LARGE CHANDELIER**  
NIERMANN WEEKS  
  
**NW5051**  
Fixture: 34" H | W: 34" | Canopy: 5" Round  
Socket: 6 - E12 Candelabra | Bulb: 6 - 60 C



**A** | **NW5051BSL**  
Burnished Silver Leaf | Clear Glass



**B** | **NW5041AM/HAB**  
Antique Mirror | Brass

**B** | **LIDO LARGE CHANDELIER**  
NIERMANN WEEKS  
  
**NW5041**  
H: 35" | W: 38.25" | Canopy: 5.5" Round  
Socket: 6 - E12 Candelabra | Bulb: 6 - 60 C

**C** | **LIDO MEDIUM CHANDELIER**  
NIERMANN WEEKS  
  
**NW5040**  
H: 33" | W: 25.5" | Canopy: 5.5" Round  
Socket: 4 - E12 Candelabra | Bulb: 4 - 60 C



**C** | **NW5040AM/HAB**  
Antique Mirror | Brass

**A** | **SN5107PN**  
Polished Nickel | Seeded Glass



**A** | **REGENCY MEDIUM CHANDELIER**  
STUDIO VC  
**SN5107**  
H: 30.75" | W: 22" | Canopy: 4.5" Round  
Socket: 6 - E12 Candelabra | Bulb: 6 - 60 C

**B** | **REGENCY LARGE CHANDELIER**  
STUDIO VC  
**SN5108**  
Fixture: 33.5" H | W: 31" | Canopy: 4.5" Round  
Socket: 8 - E12 Candelabra | Bulb: 8 - 60 C



**A** | **SN5107PN**  
Polished Nickel | Seeded Glass



**A** | **SN5107HAB**  
Hand-Rubbed Antique Brass | Seeded Glass



**A** | **SN5107SN**  
Sheffield Nickel | Seeded Glass



**B** | **SN5108PN**  
Polished Nickel | Seeded Glass



**B** | **SN5108HAB**  
Hand-Rubbed Antique Brass | Seeded Glass



**B** | **SN5108SN**  
Natural Nickel | Seeded Glass



**A** **CHC1535PN**  
Polished Nickel | Crystal

**A** **CHC1535AB**  
Antique-Burnished Brass | Crystal



**B** **CHC1530PN-NP**  
Polished Nickel | Crystal | Natural Paper

**B** **CHC1530AB-NP**  
Antique Burnished Brass | Natural Paper

**A** **CUBED ROUND FLATLINE CHANDELIER**  
E. F. CHAPMAN

**CHC1535**  
H: 25.25" | W: 30" | Canopy: 5.75" Square  
Socket: 6 - E12 Candelabra | Bulb: 6 - 60 C  
©EFC DESIGNS

**B** **CUBED LARGE CHANDELIER**  
E. F. CHAPMAN

**CHC1530**  
H: 37" | W: 34.5" | Canopy: 5.75" Square  
Socket: 6 - E12 Candelabra | Bulb: 6 - 40 B  
Shade: 3" x 5" x 5.25"  
©EFC DESIGNS

**C** **LINFORT BASKET FORM CHANDELIER**  
E. F. CHAPMAN

**CHC5271**  
H: 36" | W: 24" | Canopy: 5.75" Round  
Socket: 8 - E12 Candelabra | Bulb: 8 - 60 C  
©EFC DESIGNS



**C** **CHC5271PN-CG**  
Polished Nickel | Clear Glass Trim



**C** **CHC5271AB-CG**  
Antique-Burnished Brass | Clear Glass Trim



**A** | **CHC1508AB-SG**  
Antique-Burnished Brass | Seeded Glass



**B** | **CHC1407PS-SG**  
Polished Silver | Seeded Glass



**B** | **CHC1407GI-SG**  
Gilded Iron | Seeded Glass



**C** | **CHC1426SHS-SG**  
Sheffield Silver | Seeded Glass

**C** | **CHC1426AB-SG**  
Antique-Burnished Brass | Seeded Glass

**A** | **PARIS FLEA MARKET GRANDE CHANDELIER**  
E. F. CHAPMAN

**CHC1508**  
H: 41" | W: 39.5" | Canopy: 5.25" Round  
Socket: 12 - E12 Candelabra | Bulb: 12 - 60 C  
©EFC DESIGNS

**B** | **PARIS FLEA MARKET SMALL CHANDELIER**  
E. F. CHAPMAN

**CHC1407**  
H: 17.5" | W: 16.25" | Canopy: 5.25" Round  
Socket: 6 - E12 Candelabra | Bulb: 6 - 60 C  
©EFC DESIGNS

**C** | **PARIS FLEA MARKET MEDIUM CHANDELIER**  
E. F. CHAPMAN

**CHC1426**  
H: 26" | W: 24" | Canopy: 5.25" Round  
Socket: 8 - E12 Candelabra | Bulb: 8 - 60 C  
©EFC DESIGNS

**D** | **PARIS FLEA MARKET LARGE CHANDELIER**  
E. F. CHAPMAN

**CHC1408**  
H: 33" | W: 32" | Canopy: 5.25" Round  
Socket: 8 - E12 Candelabra | Bulb: 8 - 60 C  
©EFC DESIGNS

**Available Options for Paris Flea Market:**  
Antique-Burnished Brass | Seeded Glass (AB-SG)  
Gilded Iron | Seeded Glass (GI-SG)  
Polished Silver | Seeded Glass (PS-SG)  
Sheffield Silver | Seeded Glass (SHS-SG)

**General Notes for Paris Flea Market:**  
\* Glass is Intended to Fill Half of the Spaces  
\* Additional Trim is Available for Purchase



**D** | **CHC1408AB-SG**  
Antique-Burnished Brass | Seeded Glass

**A ENTELLINA CHANDELIER**  
JULIE NEILL

**JN5016**  
H: 40" | W: 32.5" | Canopy: 6.25" Round  
Socket: 6 - E12 Candelabra | Bulb: 6 - 40 B

**B LYON LARGE CHANDELIER**  
NIERMANN WEEKS

**NW5016**  
Fixture: 57" H | W: 39.75" | Canopy: 6" Round  
Socket: 12 - E12 Candelabra | Bulb: 12 - 60 C



**A JN5016VWG-CG**  
Vintage White | Gild | Crystal



**B NW5016AGP-CG**  
Antique Gild | Polychrome | Crystal



**C SHARON SMALL CHANDELIER**  
J. RANDALL POWERS

**SP5030**  
H: 36" | W: 24" | Canopy: 6" Round  
Socket: 4 - E12 Candelabra | Bulb: 4 - 60 C

**D SHARON MEDIUM CHANDELIER**  
J. RANDALL POWERS

**SP5031**  
H: 54" | W: 36" | Canopy: 6" Round  
Socket: 6 - E12 Candelabra | Bulb: 6 - 60 C



**C SP5030GI-CG**  
Gilded Iron | Crystal Trim



**C SP5030BSL-CG**  
Burnished Silver Leaf | Crystal Trim



**D SP5031GI-CG**  
Gilded Iron | Crystal Trim



**D SP5031BSL-CG**  
Burnished Silver Leaf | Crystal Trim





**A MONTMARTRE MEDIUM CHANDELIER**  
AERIN  
**ARN5129**  
Fixture: 29.75" H | W: 30" | Canopy: 7" Round  
Socket: 6 - E12 Candelabra | Bulb: 6 - 60 C

**B MONTMARTRE LARGE CHANDELIER**  
AERIN  
**ARN5110**  
Fixture: 39.25" H | W: 39.75" | Canopy: 7" Round  
Socket: 8 - E12 Candelabra | Bulb: 8 - 60 C



**C TOB5470BSL**  
Burnished Silver Leaf | Crystal



**C TOB5470GI**  
Gilded Iron | Crystal



**D ARN5108HAB-CG**  
Hand-Rubbed Antique Brass | Crystal

**D WHITLEY MEDIUM CHANDELIER**  
J. RANDALL POWERS  
**SP5803**  
Fixture: 41" H | W: 34.5" | Canopy: 5" Round  
Socket: 8 - E12 Candelabra | Bulb: 8 - 60 C

**E VESTRY CHANDELIER**  
AERIN  
**ARN5108**  
H: 48" | W: 41" | Canopy: 7.5" Round  
Socket: 12 - E12 Candelabra | Bulb: 12 - 60 C



**E SP5803GI-CG**  
Gilded Iron | Crystal

**A ARN5129PN-CG**  
Polished Nickel | Crystal

**A ARN5129HAB-CG**  
Hand-Rubbed Antique Brass | Crystal



**C YVES MEDIUM CHANDELIER**  
THOMAS O'BRIEN  
**TOB5470**  
Fixture: 35.75" H | W: 31" | Canopy: 6" Decorative  
Socket: 9 - E12 Candelabra | Bulb: 9 - 60 C

**B ARN5110PN-CG**  
Polished Nickel | Crystal

**B ARN5110HAB-CG**  
Hand-Rubbed Antique Brass | Crystal

**A** **ELIZABETH CHANDELIER**  
THOMAS O'BRIEN  
  
**TOB5036**  
H: 26" | W: 33" | Canopy: 6" Round  
Socket: 6 - E12 Candelabra | Bulb: 6 - 60 C



**A** **TOB5036BSL**  
Burnished Silver Leaf | Quartz



**A** **TOB5036GI**  
Gilded Iron | Quartz



**B** **GALLINA MEDIUM CHANDELIER**  
NIERMANN WEEKS  
  
**NW5160**  
Fixture: 48" H | W: 37.75" | Canopy: 5" Round  
Socket: 8 - E12 Candelabra | Bulb: 8 - 60 C

**B** **NW5160ASL-CG**  
Antique Silver Leaf | Clear Glass

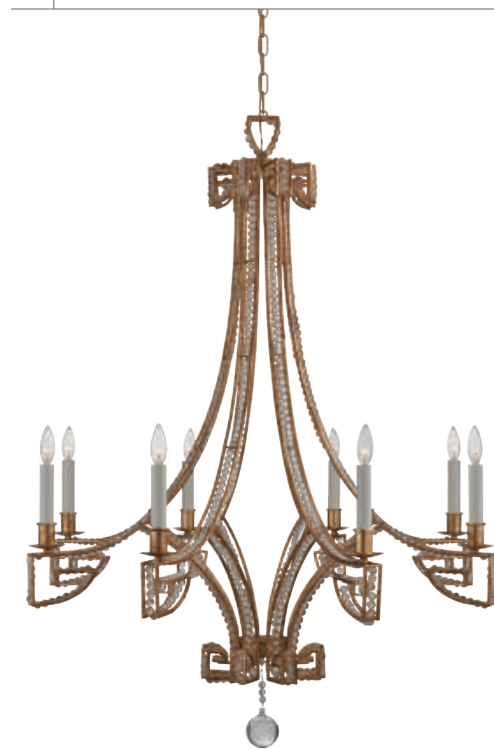

**B** **NW5160GI-CG**  
Gilded Iron | Clear Glass

**C** **MILAN MEDIUM CHANDELIER**  
NIERMANN WEEKS  
  
**NW5030**  
Fixture: 36" H | W: 29.25" | Canopy: 6" Round  
Socket: 6 - E12 Candelabra | Bulb: 6 - 60 C

**D** **MILAN LARGE CHANDELIER**  
NIERMANN WEEKS  
  
**NW5031**  
Fixture: 44" H | W: 38" | Canopy: 6" Round  
Socket: 6 - E12 Candelabra | Bulb: 6 - 60 C



**C** **NW5030VS**  
Venetian Silver | Crystal



**D** **NW5031VS**  
Venetian Silver | Crystal



**C** **NW5030VG**  
Venetian Gold | Crystal



**D** **NW5031VG**  
Venetian Gold | Crystal

**A OSLO MINI CHANDELIER**  
E. F. CHAPMAN  
  
**CHC1559**  
Fixture: 15" H | W: 17" | Canopy: 5.5" Round  
Socket: 5 - E12 Candelabra | Bulb: 5 - 60 C  
©EFC DESIGNS

**B OSLO SMALL CHANDELIER**  
E. F. CHAPMAN  
  
**CHC1552**  
H: 26.25" | W: 23.25" | Canopy: 5.5" Round  
Socket: 6 - E12 Candelabra | Bulb: 6 - 60 C  
©EFC DESIGNS

**C OSLO MEDIUM CHANDELIER**  
E. F. CHAPMAN  
  
**CHC1550**  
H: 33.75" | W: 32.75" | Canopy: 5.5" Round  
Socket: 6 - E12 Candelabra | Bulb: 6 - 60 C  
©EFC DESIGNS

**D OSLO LARGE CHANDELIER**  
E. F. CHAPMAN  
  
**CHC1551**  
H: 44.75" | W: 43.25" | Canopy: 6.25" Round  
Socket: 8 - E12 Candelabra | Bulb: 8 - 60 C  
©EFC DESIGNS

**Additional Options for Oslo:**  
Burnished Silver Leaf | Crystal (BSL-CG)  
Gilded Iron | Crystal (GI-CG)



**A CHC1559BSL-CG**  
Burnished Silver Leaf | Crystal

**A CHC1559GI-CG**  
Gilded Iron | Crystal

**B CHC1552BSL-CG**  
Burnished Silver Leaf | Crystal

**B CHC1552GI-CG**  
Gilded Iron | Crystal

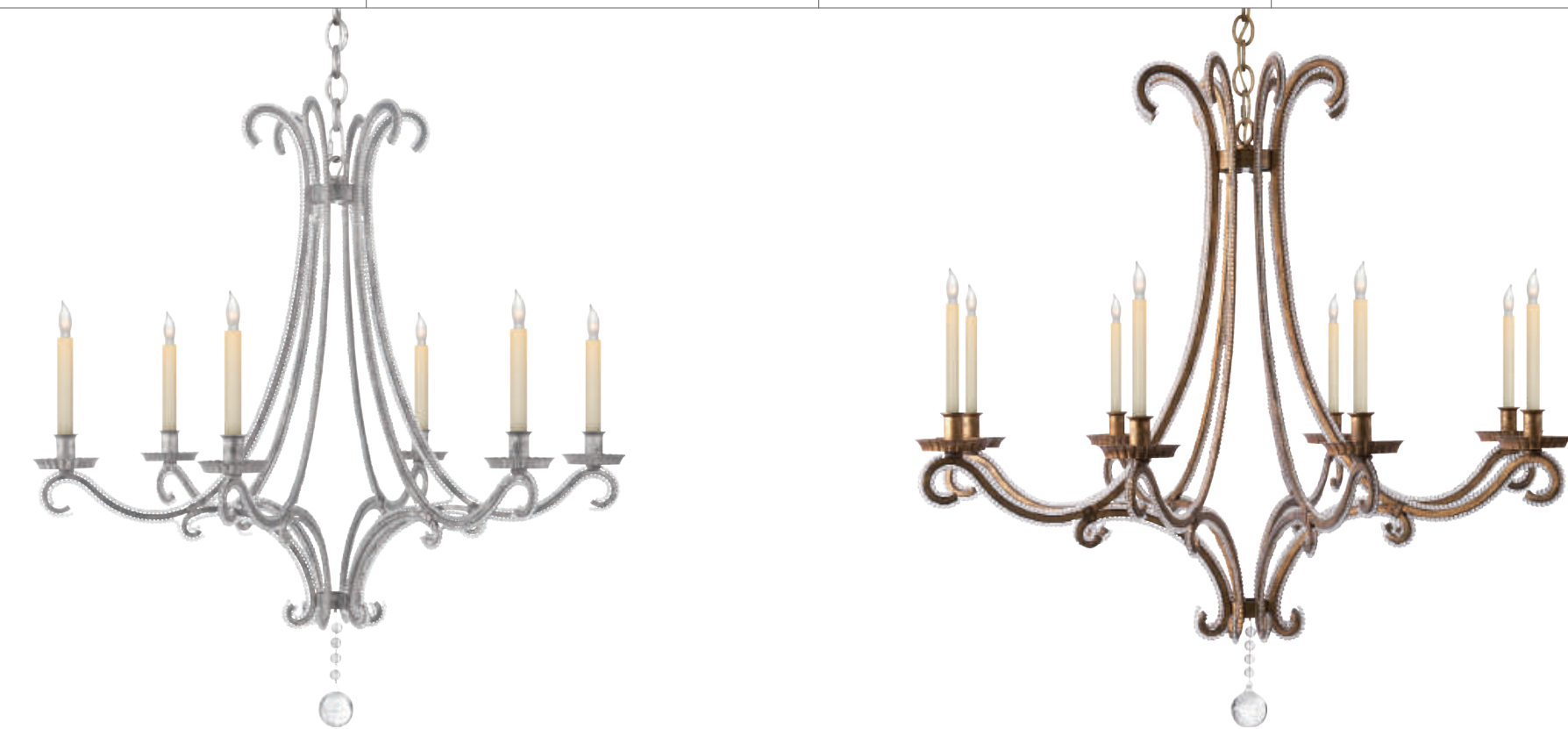

**C CHC1550BSL-CG**  
Burnished Silver Leaf | Crystal

**D CHC1551GI-CG**  
Gilded Iron | Crystal



**C CHC1550BSL-CG**  
Burnished Silver Leaf | Crystal



**A** **CHC2138PN-CG**  
Polished Nickel | Clear Glass



**A** **CHC2138GI-CG**  
Gilded Iron | Clear Glass



**B** **NW5006RS-CG**  
Rusted Steel | Clear Glass



opposite page

**A** **DEVON MINI GLASS BOWL CHANDELIER**  
E. F. CHAPMAN

**CHC2138**  
H: 17" | W: 11" | Canopy: 5" Round  
Socket: 4 - E12 Candelabra | Bulb: 4 - 60 C  
©EFC DESIGNS

**B** **LOMBARDY DOUBLE TIER CHANDELIER**  
NIERMANN WEEKS

**NW5006**  
Fixture: 36" H | W: 36" | Canopy: 5" Round  
Socket: 12 - E12 Candelabra | Bulb: 12 - 60 C

**C** **PIEDMONT CHANDELIER**  
E. F. CHAPMAN

**CHC1420**  
H: 33" | W: 32" | Canopy: 5.5" Round  
Socket: 6 - E12 Candelabra | Bulb: 6 - 60 C  
\* CHS104NP Shade Sold Separately  
\* Use 40 Bulb Frosted Type "B" with Clip On Shade  
©EFC DESIGNS

**D** **ORVIETO LARGE CHANDELIER**  
E. F. CHAPMAN

**CHC1520**  
H: 43.75" | W: 33.5" | Canopy: 5.5" Round  
Socket: 12 - E12 Candelabra | Bulb: 12 - 60 C  
©EFC DESIGNS



**C** **CHC1420GI-SG**  
Gilded Iron | Seeded Glass



**D** **CHC1520GI-SG**  
Gilded Iron | Seeded Glass



**C** **CHC1420AI-SG**  
Aged Iron | Seeded Glass



**D** **CHC1520AI-SG**  
Aged Iron | Seeded Glass



**A** | **CHC1140PN**  
Polished Nickel | Clear Glass



**A** | **CHC1140AB**  
Antique-Burnished Brass | Clear Glass

**A** | **ROBINSON MEDIUM CHANDELIER**  
E. F. CHAPMAN  
  
**CHC1140**  
H: 30.25" | W: 32" | Canopy: 5.5" Round  
Socket: 6 - E12 Candelabra | Bulb: 6 - 60 C  
\* Assembly Required  
©EFC DESIGNS



**B** | **CHC1141PN**  
Polished Nickel | Clear Glass



**B** | **CHC1141AB**  
Antique-Burnished Brass | Clear Glass

**B** | **ROBINSON LARGE CHANDELIER**  
E. F. CHAPMAN  
  
**CHC1141**  
H: 35.75" | W: 38" | Canopy: 5.5" Round  
Socket: 6 - E12 Candelabra | Bulb: 6 - 60 C  
\* Assembly Required  
©EFC DESIGNS



**A** | **CHC1140AB**  
Antique-Burnished Brass | Clear Glass

**C** | **BENNETT SIX ARM CHANDELIER**  
E. F. CHAPMAN  
  
**CHC1180**  
Fixture: 24.75" H | W: 28.25" | Canopy: 6.5" Oct.  
Socket: 6 - E12 Candelabra | Bulb: 6 - 40 B  
Shade: 4.5" x 5.5" x 5.5"  
\* Assembly Required  
©EFC DESIGNS



**C** | **CHC1180CG/PN-PL**  
Crystal | Polished Nickel | Percalé



**B** | **CHC1154CG/PN**  
Crystal | Polished Nickel

**A** | **GEORGE II MINI CHANDELIER**  
E. F. CHAPMAN  
  
**CHC1156**  
H: 14" | W:13.75" | Canopy: 5.5" Round  
Socket: 6 - E12 Candelabra | Bulb: 6 - 60 C  
\* Assembly Required  
©EFC DESIGNS



**B** | **GEORGE II LARGE CHANDELIER**  
E. F. CHAPMAN  
  
**CHC1154**  
H: 31" | W: 30" | Canopy: 5.5" Round  
Socket: 6 - E12 Candelabra | Bulb: 6 - 60 C  
\* Assembly Required  
©EFC DESIGNS



**A** | **CHC1156CG/PN**  
Crystal | Polished Nickel

**B** | **CHC1154CG/PN**  
Crystal | Polished Nickel

**C** | **GEORGE II SMALL CHANDELIER**  
E. F. CHAPMAN  
  
**CHC1155**  
H: 23.5" | W: 22" | Canopy: 5.5" Round  
Socket: 6 - E12 Candelabra | Bulb: 6 - 60 C  
\* Assembly Required  
©EFC DESIGNS



**D** | **KING GEORGE GRANDE ROUND CHANDELIER**  
E. F. CHAPMAN  
  
**CHC1144**  
H: 36" | W: 36" | Canopy: 5.5" Round  
Socket: 8 - E12 Candelabra | Bulb: 8 - 60 C  
\* Assembly Required  
©EFC DESIGNS



**C** | **CHC1155CG/PN**  
Crystal | Polished Nickel

**D** | **CHC1144CG/PN**  
Crystal | Polished Nickel



**A** **TOB5031PN-NP**  
Polished Nickel | Crystal | Natural Paper



**A** **TOB5031HAB-NP**  
Hand-Rubbed Antique Brass | Crystal | Natural Paper



**B** **TOB5032PN-NP**  
Polished Nickel | Crystal | Natural Paper



**B** **TOB5032HAB-NP**  
Hand-Rubbed Antique Brass | Crystal | Natural Paper



**C** **TOB5033PN-NP**  
Polished Nickel | Crystal | Natural Paper

**A** **VIVIAN MINI CHANDELIER**  
THOMAS O'BRIEN  
  
**TOB5031**  
H: 14" | W: 18.5" | Canopy: 6" Round  
Socket: 4 - E12 Candelabra | Bulb: 4 - 40 B  
Shade: 3.5" x 4" x 5.5"  
\* Assembly Required

**B** **VIVIAN LARGE ONE-TIER CHANDELIER**  
THOMAS O'BRIEN  
  
**TOB5032**  
H: 25" | W: 36" | Canopy: 6" Round  
Socket: 8 - E12 Candelabra | Bulb: 8 - 40 B  
Shade: 3.25" x 4" x 4.25"  
\* Assembly Required

**C** **VIVIAN LARGE TWO-TIER CHANDELIER**  
THOMAS O'BRIEN  
  
**TOB5033**  
H: 25" | W: 36" | Canopy: 6" Round  
Socket: 12 - E12 Candelabra | Bulb: 12 - 40 B  
Shade: 3.25" x 4" x 4.25"  
\* Assembly Required



**C** **TOB5033HAB-NP**  
Hand-Rubbed Antique Brass | Crystal | Natural Paper





**A** | **KW5400CRB/PN**  
Clear Ribbed Glass | Nickel



**A** | **KW5400CRB/AB**  
Clear Ribbed Glass | Brass



**A** | **KW5400CRB/BZ**  
Clear Ribbed Glass | Bronze



**B** | **KW5401CRB/PN**  
Clear Ribbed Glass | Nickel



**B** | **KW5401CRB/AB**  
Clear Ribbed Glass | Brass



**B** | **KW5401CRB/BZ**  
Clear Ribbed Glass | Bronze

opposite page

**A** | **REVERIE SMALL ONE-TIER CHANDELIER**  
KELLY WEARSTLER

**KW5400**  
H: 25.5" | W: 18" | Canopy: 4.25" Round  
Socket: 7 - E12 Candelabra | Bulb: 7 - 40 B

**B** | **REVERIE MEDIUM ONE-TIER CHANDELIER**  
KELLY WEARSTLER

**KW5401**  
H: 38" | W: 30" | Canopy: 4.25" Round  
Socket: 10 - E12 Candelabra | Bulb: 10 - 40 B



**C** | **ARN5116PN-CG**  
Clear Acrylic | Polished Nickel



**C** | **ARN5116HAB-CG**  
Clear Acrylic | Brass

**C** | **WHARTON CHANDELIER**  
AERIN

**ARN5116**  
H: 31" | W: 37.75" | Canopy: 4.5" Round  
Socket: 15 - E12 Candelabra | Bulb: 15 - 60 C

**D** | **CLARICE LARGE CHANDELIER**  
JULIE NEILL

**JN5030**  
H: 40" | W: 43.25" | Canopy: 5.5" Round  
Socket: 16 - E12 Candelabra | Bulb: 16 - 40 B  
Shade: 4.25" x 5" x 6"  
\* Requires Special Assembly and Installation



**D** | **JN5030CG/PN-L**  
Crystal | Polished Nickel | Linen



**D** | **JN5030CG/AB-L**  
Crystal | Antique-Burnished Brass | Linen





**B** | **CHC5287AB-CA**  
Antique-Burnished Brass | Clear Acrylic

**A** | **QUINCY SMALL SPUTNIK CHANDELIER**  
E. F. CHAPMAN  
  
**CHC5286**  
H: 20" | W: 20" | Canopy: 5.75" Round  
Socket: 20 - E12 Candelabra | Bulb: 20 - 25 C  
©EFC DESIGNS

**B** | **QUINCY MEDIUM SPUTNIK CHANDELIER**  
E. F. CHAPMAN  
  
**CHC5287**  
H: 30" | W: 30" | Canopy: 5.75" Round  
Socket: 20 - E12 Candelabra | Bulb: 20 - 25 C  
©EFC DESIGNS

**C** | **CHIARA LARGE SPUTNIK CHANDELIER**  
JULIE NEILL  
  
**JN5119**  
H: 70" | Fixture: 32" H | W: 32"  
Canopy: 5" Round  
Socket: 16 - E12 Candelabra | Bulb: 16 - 40 C



**A** | **CHC5286PN-CA**  
Polished Nickel | Clear Acrylic

**A** | **CHC5286AB-CA**  
Antique-Burnished Brass | Clear Acrylic

**B** | **CHC5287PN-CA**  
Polished Nickel | Clear Acrylic

**B** | **CHC5287AB-CA**  
Antique-Burnished Brass | Clear Acrylic

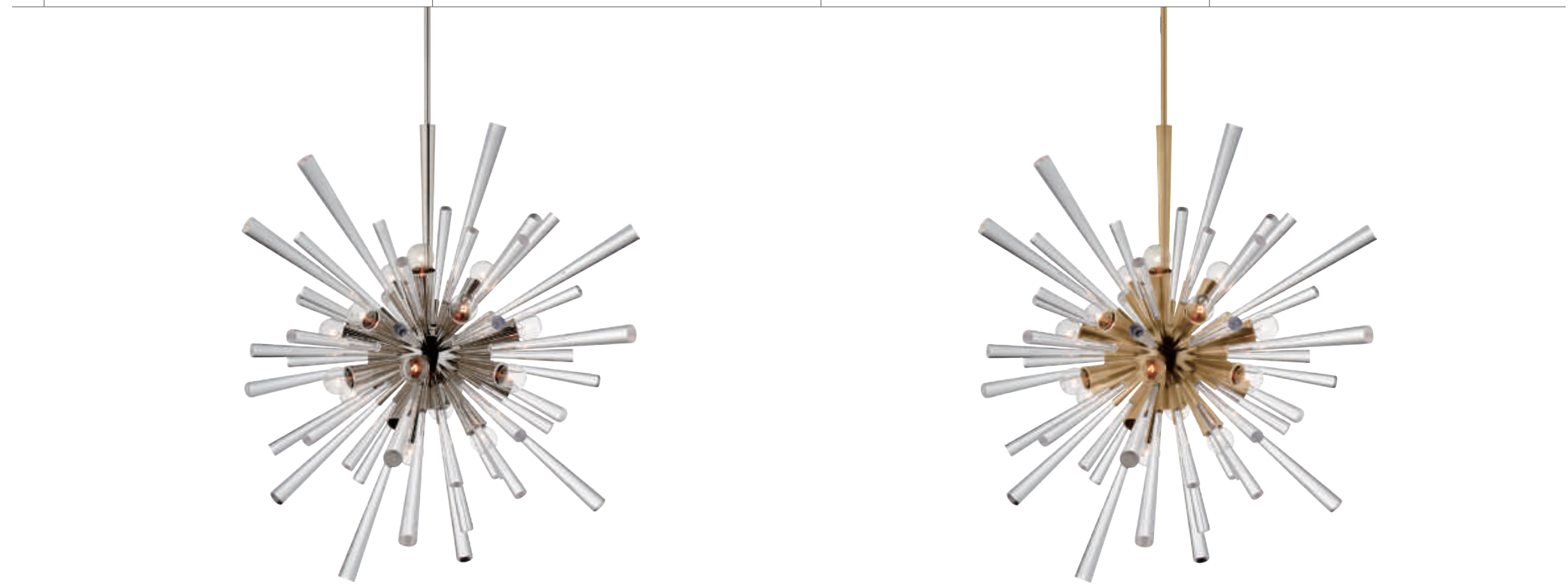

**C** | **JN5119PN/CA**  
Polished Nickel | Clear Acrylic

**C** | **JN5119AB/CA**  
Antique-Burnished Brass | Clear Acrylic



**A** **KS5003PN-CG**  
Polished Nickel | Clear Glass | Pearls

**A** **KS5003SB-CG**  
Soft Brass | Clear Glass | Pearls



**C** **KS5006SB-CG**  
Soft Brass | Clear Glass | Pearls



**B** **KS5004PN-CG**  
Polished Nickel | Clear Glass | Pearls



**B** **KS5004SB-CG**  
Soft Brass | Clear Glass | Pearls

opposite page

**A** **DICKINSON MINI CHANDELIER**  
kate spade new york

**KS5003**  
O/A H: 42.5" | Fixture: 9" H | W: 10.25"  
Canopy: 5.5" Round  
Socket: 7 - E12 Candelabra | Bulb: 7 - 40 G  
\* Custom Height Available (14" Minimum)

**B** **DICKINSON SMALL CHANDELIER**  
kate spade new york

**KS5004**  
H: 49.5" | Fixture: 17" H | W: 17"  
Canopy: 5.25" Round  
Socket: 13 - E12 Candelabra | Bulb: 13 - 60 G  
\* Custom Height Available (24" Minimum)

**C** **DICKINSON LARGE CHANDELIER**  
kate spade new york

**KS5006**  
H: 64.75" | Fixture: 31.5" H | W: 32"  
Canopy: 8" Round  
Socket: 21 - E12 Candelabra | Bulb: 21 - 40 G  
**Additional Options:**  
Polished Nickel | Clear Glass | Pearls (PN-CG)  
\* Custom Height Available (45" Minimum)

**D** **DICKINSON MEDIUM CHANDELIER**  
kate spade new york

**KS5005**  
H: 55.5" | Fixture: 22" H | W: 22.25"  
Canopy: 5.5" Round  
Socket: 17 - E12 Candelabra | Bulb: 17 - 40 G  
**Additional Options:**  
Polished Nickel | Clear Glass | Pearls (PN-CG)  
\* Custom Height Available (31" Minimum)



**D** **KS5005SB-CG**  
Soft Brass | Clear Glass | Pearls



**A** | **ARN5100BSL-CG**  
Burnished Silver Leaf | Crystal

**A** | **RENWICK SMALL SPHERE CHANDELIER**  
AERIN

**ARN5100**  
H: 21.5" | W: 19" | Canopy: 6.75" Round  
Socket: 4 - E12 Candelabra | Bulb: 4 - 60 C

**B** | **RENWICK LARGE SPHERE CHANDELIER**  
AERIN

**ARN5101**  
Fixture: 27.5" H | W: 23.25" | Canopy: 6.75" Round  
Socket: 4 - E12 Candelabra | Bulb: 4 - 60 C



**A** | **ARN5100BSL-CG**  
Burnished Silver Leaf | Crystal

**B** | **ARN5101BSL-CG**  
Burnished Silver Leaf | Crystal

**A** | **ARN5100G-CG**  
Gild | Crystal

**B** | **ARN5101G-CG**  
Gild | Crystal



A TOB5290BZ/HAB-L  
Bronze | Hand-Rubbed Antique Brass | Linen

A OSIRIS LARGE REFLECTOR CHANDELIER  
THOMAS O'BRIEN

TOB5290  
H: 49.5" | Fixture: 21.5" H | W: 54"  
Canopy: 5" Round  
Socket: 8 - E26 Keyless | Bulb: 8 - 40 A  
\* UL Only



A TOB5290PN-L  
Polished Nickel | Linen



A TOB5290HAB-L  
Hand-Rubbed Antique Brass | Linen

B OSIRIS MEDIUM REFLECTOR CHANDELIER  
THOMAS O'BRIEN

TOB5288  
H: 52" | Fixture: 32" H | W: 33"  
Canopy: 5.75" Round  
Socket: 8 - E26 Keyless | Bulb: 8 - 40 A  
\* Custom Height Available (29" Minimum)



B TOB5288PN-L  
Polished Nickel | Linen



B TOB5288HAB-L  
Hand-Rubbed Antique Brass | Linen



B TOB5288BZ/HAB-L  
Bronze | Hand-Rubbed Antique Brass | Linen

**A ALPINE SMALL CHANDELIER**  
 AERIN  
**ARN5308**  
 H: 47.75" | Fixture: 16.25" H | W: 20.25"  
 Canopy: 4.25" Round  
 Socket: 8 - E12 Candelabra | Bulb: 8 - 60 C  
 \* UL Only



**B ALPINE MEDIUM CHANDELIER**  
 AERIN  
**ARN5310**  
 O/A H: 51.5" | Fixture: 16" H | W: 30.25"  
 Canopy: 4.25" Round  
 Socket: 16 - E12 Candelabra | Bulb: 16 - 40 C  
 \* Custom Height Available (26" Minimum)

**A** **ARN5310HAB-CG**  
 Hand-Rubbed Antique Brass | Clear Glass



**A** **ARN5308PN-CG**  
 Polished Nickel | Clear Glass

**A** **ARN5308PN-WG**  
 Polished Nickel | White Glass

**A** **ARN5308HAB-CG**  
 Hand-Rubbed Antique Brass | Clear Glass

**A** **ARN5308HAB-WG**  
 Hand-Rubbed Antique Brass | White Glass



**B** **ARN5310PN-CG**  
 Polished Nickel | Clear Glass

**B** **ARN5310PN-WG**  
 Polished Nickel | White Glass

**B** **ARN5310HAB-WG**  
 Hand-Rubbed Antique Brass | White Glass



A | **ARN5272PN-CG**  
Polished Nickel | Clear Glass



A | **ARN5272HAB-CG**  
Hand-Rubbed Antique Brass | Clear Glass

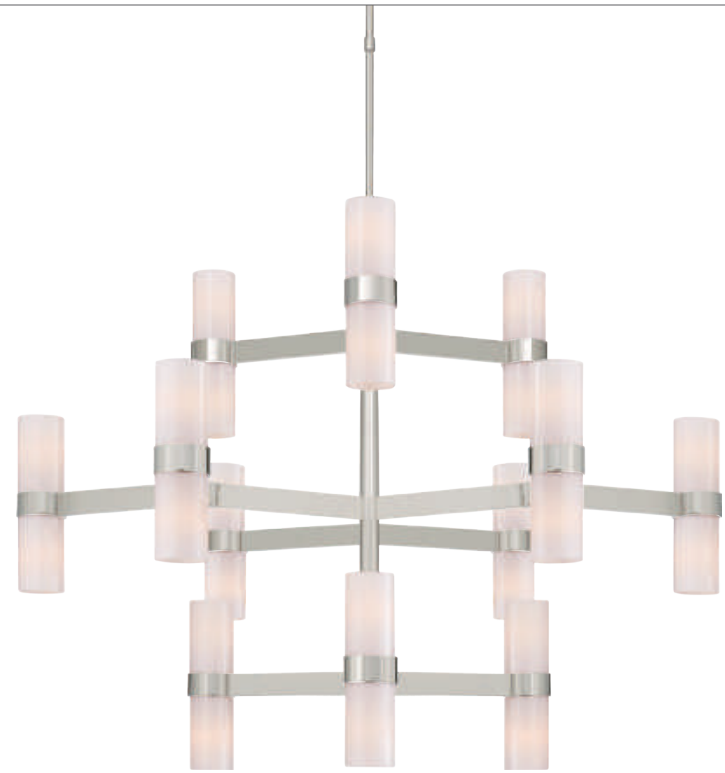

A | **ARN5272PN-WG**  
Polished Nickel | White Glass



A | **ARN5272HAB-WG**  
Hand-Rubbed Antique Brass | White Glass

A | **MARGITA MEDIUM CHANDELIER**  
AERIN

**ARN5272**  
H: 69.25" | Fixture: 33.25" H | W: 44.5"  
Canopy: 7" Hexagon  
Socket: 24 - E12 Candelabra | Bulb: 24 - 25 B  
\* Requires Special Assembly and Installation  
\* Custom Height Available (37.75" Minimum)

A | **ARN5272HAB-WG**  
Hand-Rubbed Antique Brass | White Glass





**A** **KW5200PN-CRG**  
Polished Nickel | Crackle Glass



**A** **KW5200AB-CRG**  
Antique-Burnished Brass | Crackle Glass



**A** **KW5200BZ-CRG**  
Bronze | Crackle Glass



**B** **KW5201PN-CRG**  
Polished Nickel | Crackle Glass



**B** **KW5201AB-CRG**  
Antique-Burnished Brass | Crackle Glass



**B** **KW5201BZ-CRG**  
Bronze | Crackle Glass



**C** **KW5202AB-CRG**  
Antique-Burnished Brass | Crackle Glass

**A** **LIAISON ONE-TIER CHANDELIER**  
KELLY WEARSTLER

**KW5200**  
Fixture: 16.5" H | W: 20.5" | Canopy: 6" Round  
Socket: 8 - E12 Candelabra | Bulb: 8 - 60 C

**B** **LIAISON TWO-TIER CHANDELIER**  
KELLY WEARSTLER

**KW5201**  
Fixture: 28.5" H | W: 34" | Canopy: 6" Round  
Socket: 20 - E12 Candelabra | Bulb: 20 - 40 C

**C** **LIAISON THREE-TIER CHANDELIER**  
KELLY WEARSTLER

**KW5202**  
Fixture: 39.5" H | W: 47.5" | Canopy: 6" Round  
Socket: 32 - E12 Candelabra | Bulb: 32 - 40 C  
**Additional Options:**  
Bronze | Crackle Glass (BZ-CRG)  
Polished Nickel | Crackle Glass (PN-CRG)



**A** **TOB5303PN-CG**  
Polished Nickel | Clear Glass

**A** **TOB5303HAB-CG**  
Hand-Rubbed Antique Brass | Clear Glass

**A** **TOB5303BZ/HAB-CG**  
Bronze | Hand-Rubbed Antique Brass | Clear Glass

**A** **MARAIS LARGE CHANDELIER**  
THOMAS O'BRIEN  
  
**TOB5303**  
H: 54.5" | Fixture: 26.75" H | W: 45"  
Canopy: 6" Round  
Socket: 12 - E12 Candelabra | Bulb: 12 - 60 C



**B** **KW5602AB-ALB**  
Antique-Burnished Brass | Alabaster



**A** **TOB5303PN-WG**  
Polished Nickel | White Glass

**A** **TOB5303HAB-WG**  
Hand-Rubbed Antique Brass | White Glass

**A** **TOB5303BZ/HAB-WG**  
Bronze | Hand-Rubbed Antique Brass | White Glass

**B** **MELANGE LARGE FLOATING DISC CHANDELIER**  
KELLY WEARSTLER  
  
**KW5602**  
H: 47.75" | Fixture: 14" H | W: 45"  
Canopy: 5" Round | LED: 12w  
**Additional Options:**  
Polished Nickel | Alabaster (PN-ALB)



**B** **KW5602BZ-ALB**  
Bronze | Alabaster



B KW5587AB-EC  
Antique-Burnished Brass | Etched Crystal



A ROUSSEAU 8-LIGHT ARTICULATING CHANDELIER  
KELLY WEARSTLER

KW5589  
H: 51.75" | Fixture: 14.5" H | W: 65"  
Canopy: 4.5" Round | LED: 34w

B ROUSSEAU GRANDE ARTICULATING CHANDELIER  
KELLY WEARSTLER

KW5587  
H: 53.75" | Fixture: 16" H | W: 50"  
Canopy: 4.5" Round | LED: 47w  
\* Requires Special Assembly and Installation  
\* Custom Height Available (23.5" Minimum)

**Available Options for Rousseau:**  
Antique-Burnished Brass | Etched Crystal (AB-EC)  
Bronze | Etched Crystal (BZ-EC)  
Polished Nickel | Etched Crystal (PN-EC)  
Antique-Burnished Brass | Seeded Glass (AB-SG)  
Bronze | Etched Crystal (BZ-EC)  
Bronze | Seeded Glass (BZ-SG)  
Polished Nickel | Seeded Glass (PN-SG)



A KW5589PN-EC  
Polished Nickel | Etched Crystal

A KW5589AB-SG  
Antique-Burnished Brass | Seeded Glass



B KW5587AB-EC  
Antique-Burnished Brass | Etched Crystal

B KW5587BZ-SG  
Bronze | Seeded Glass



**A** | **KW5112PN-ALB**  
Polished Nickel | Alabaster

**A** | **KW5112AB-ALB**  
Antique-Burnished Brass | Alabaster

**A** | **KW5112BZ-ALB**  
Bronze | Alabaster



**B** | **KW5115AB-ALB**  
Antique-Burnished Brass | Alabaster

**B** | **KW5115BZ-ALB**  
Bronze | Alabaster

opposite page

**A** | **COVET SMALL CHANDELIER**  
KELLY WEARSTLER

**KW5112**  
H: 71" | Fixture: 18.75" H | W: 20" x 17.75"  
Canopy: 4.5" x 7" Rec.  
Socket: 6 - E26 Keyless | Bulb: 6 - 9w LED T  
\* Bulb Included

**B** | **COVET LARGE CHANDELIER**  
KELLY WEARSTLER

**KW5115**  
H: 73.5" | Fixture: 21.5" H | W: 44" x 31.25"  
Canopy: 6" x 18" Rec.  
Socket: 12 - E26 Keyless | Bulb: 12 - 9w LED T  
\* Bulb Included  
**Additional Options:**  
Polished Nickel | Alabaster (PN-ALB)

**C** | **HALCYON THREE-TIER CHANDELIER**  
KELLY WEARSTLER

**KW5012**  
O/A H: 77.5" | Fixture: 48" H | W: 36"  
Canopy: 4.5" Round  
Socket: 6 - E12 Candelabra | Bulb: 6 - 60 C  
\* Custom Height Available (56" Minimum)



**C** | **KW5012AB-Q**  
Antique-Burnished Brass | Quartz



**A** | **S5143PN-CA**  
Polished Nickel | Clear Acrylic



**A** | **S5143HAB-CA**  
Hand-Rubbed Antique Brass | Clear Acrylic

**A** | **PALOMAR SMALL ROTATING CHANDELIER**  
IAN K. FOWLER

**S5143**  
H: 44.25" | Fixture: 24" H | W: 34"  
Canopy: 5.5" Round  
Socket: 40 - G9 Keyless | Bulb: 40 - 2w LED  
\* UL Only  
\* Bulbs Included

**B** | **PRESIDIO MEDIUM CHANDELIER**  
IAN K. FOWLER

**S5680**  
H: 56.75" | Fixture: 22" H | W: 36.5"  
Canopy: 6.5" Round  
Socket: 12 - E12 Candelabra | Bulb: 12 - 40 T  
\* Requires Special Assembly and Installation  
\* Custom Height Available (25.5" Minimum)



**B** | **S5680PN-CG**  
Polished Nickel | Clear Glass



**B** | **S5680HAB-CG**  
Hand-Rubbed Antique Brass | Clear Glass

**A** | **S5143HAB-CA**  
Hand-Rubbed Antique Brass | Clear Acrylic



**C** | **HALCYON LARGE CHANDELIER**  
KELLY WEARSTLER

**KW5091**  
H: 57.75" | Fixture: 30.5" H | W: 32.75"  
Canopy: 4" Round  
Socket: 7 - E12 Candelabra | Bulb: 7 - 60 C  
\* Custom Height Available (38.5" Minimum)



**C** | **KW5091AB/Q-FRG**  
Antique-Burnished Brass | Quartz



**A** | **KW5580PN-SG**  
Polished Nickel | Seeded Glass



**A** | **KW5580AB-SG**  
Antique-Burnished Brass | Seeded Glass

**A ROUSSEAU SMALL CHANDELIER**  
KELLY WEARSTLER

**KW5580**  
H: 63.5" | Fixture: 25" H | W: 21.25"  
Canopy: 4.5" Round | LED: 15w  
\* Custom Height Available (34.5" Minimum)

**B ROUSSEAU MEDIUM CHANDELIER**  
KELLY WEARSTLER

**KW5581**  
H: 69.75" | Fixture: 32" H | W: 39.25"  
Canopy: 5" Round | LED: 36w  
\* Custom Height Available (41.5" Minimum)

**C ROUSSEAU LARGE OVAL CHANDELIER**  
KELLY WEARSTLER

**KW5585**  
H: 59.75" | Fixture: 22" H | W: 50"  
Canopy: 5" Round | LED: 72w  
\* Requires Special Assembly and Installation  
\* Custom Height Available (38" Minimum)

**Available Options for Rousseau:**  
Antique-Burnished Brass | Etched Crystal (AB-EC)  
Bronze | Etched Crystal (BZ-EC)  
Polished Nickel | Etched Crystal (PN-EC)  
Antique-Burnished Brass | Seeded Glass (AB-SG)  
Bronze | Etched Crystal (BZ-EC)  
Bronze | Seeded Glass (BZ-SG)  
Polished Nickel | Seeded Glass (PN-SG)



**B** | **KW5581PN-EC**  
Polished Nickel | Etched Crystal



**B** | **KW5581AB-EC**  
Antique-Burnished Brass | Etched Crystal



**C** | **KW5585PN-SG**  
Polished Nickel | Seeded Glass



**C** | **KW5585AB-SG**  
Antique-Burnished Brass | Seeded Glass



**C** | **KW5585BZ-EC**  
Bronze | Etched Crystal



**C** | **KW5585AB-EC**  
Antique-Burnished Brass | Etched Crystal



**A** **KW5511AB-WHT**  
Antique-Burnished Brass | White | White Marble



**A** **KW5511AB-BLK**  
Antique-Burnished Brass | Black | Black Marble



**B** **S5040AI**  
Aged Iron | Brass

opposite page

**A** **CLEO ONE-TIER CHANDELIER**  
KELLY WEARSTLER

**KW5511**  
Fixture: 19.25" H | W: 36.75"  
Canopy: 7" Round  
Socket: 12 - E12 Candelabra | Bulb: 12 - 40 B  
\* Cannot Be Modified in the Field  
\* Custom Height Available (33" Minimum)



**B** **S5040AI**  
Aged Iron | Brass



**B** **S5040PN**  
Polished Nickel

**B** **CHOROS ONE-TIER CHANDELIER**  
BARRY GORALNICK

**S5040**  
H: 30" | W: 28" | Canopy: 5.75" Round  
Socket: 6 - E12 Candelabra | Bulb: 6 - 60 C

**C** **CHOROS TWO-TIER CHANDELIER**  
BARRY GORALNICK

**S5041**  
H: 43" | W: 37.25" | Canopy: 5.5" Round  
Socket: 12 - E12 Candelabra | Bulb: 12 - 60 C



**C** **S5041AI**  
Aged Iron



**C** **S5041PN**  
Polished Nickel



A | **CHC1561AB**  
Antique-Burnished Brass

**A MYKONOS SMALL CHANDELIER**  
E. F. CHAPMAN

**CHC1561**  
H: 29" | W: 27.5" | Canopy: 6.5" Oct.  
Socket: 8 - E12 Candelabra | Bulb: 8 - 60 C  
\* CHS104NP Sold Separately  
\* Use 40 Bulb Frosted Type "B" with Clip On Shade  
©EFC DESIGNS



A | **CHC1561AB**  
Antique-Burnished Brass



A | **CHC1561AI**  
Aged Iron

**B MYKONOS LARGE CHANDELIER**  
E. F. CHAPMAN

**CHC1562**  
H: 38.75" | W: 37" | Canopy: 6.5" Oct.  
Socket: 8 - E12 Candelabra | Bulb: 8 - 60 C  
\* CHS104NP Sold Separately  
\* Use 40 Bulb Frosted Type "B" with Clip On Shade  
©EFC DESIGNS



B | **CHC1562AB**  
Antique-Burnished Brass



B | **CHC1562AI**  
Aged Iron



A SC5015PN  
Polished Nickel

A SC5015AS  
Antique Silver

A SC5015HAB  
Hand-Rubbed Antique Brass

A SC5015BZ  
Bronze



B SC5005PN  
Polished Nickel

B SC5005AS  
Antique Silver

B SC5005BZ  
Bronze



B SC5005HAB  
Hand-Rubbed Antique Brass

A DOUBLE TWIST SMALL CHANDELIER  
ERIC COHLER

SC5015  
H: 30" | W: 26" | Canopy: 5.75" Round  
Socket: 5 - E12 Candelabra | Bulb: 5 - 60 C

B DOUBLE TWIST LARGE CHANDELIER  
ERIC COHLER

SC5005  
H: 29.75" | W: 36" | Canopy: 5.75" Round  
Socket: 5 - E12 Candelabra | Bulb: 5 - 60 C



A SC5001PN  
Polished Nickel

A SC5001AS  
Antique Silver

A SC5001HAB  
Hand-Rubbed Antique Brass

A SC5001BZ  
Bronze



B SC5002HAB  
Hand-Rubbed Antique Brass



B SC5002BZ  
Bronze

A VENETIAN MEDIUM CHANDELIER  
ERIC COHLER

**SC5001**  
H: 23" | W: 27" | Canopy: 14.5" Star  
Socket: 6 - E12 Candelabra | Bulb: 6 - 60 C

B VENETIAN MEDIUM TWO-TIER CHANDELIER  
ERIC COHLER

**SC5002**  
H: 23.5" | W: 26.25" | Canopy: 15.25" Star  
Socket: 9 - E12 Candelabra | Bulb: 9 - 60 C  
**Additional Options:**  
Antique Silver (AS)  
Polished Nickel (PN)



C SK5021AI  
Aged Iron

C REIMS LARGE CHANDELIER  
SUZANNE KASLER

**SK5022**  
O/A H: 62" | Fixture: 24.75" H | W: 48.75"  
Canopy: 6" Round  
Socket: 9 - E12 Candelabra | Bulb: 9 - 60 C  
\* Custom Height Available (42" Minimum)

D REIMS MEDIUM CHANDELIER  
SUZANNE KASLER

**SK5021**  
O/A H: 59.25" | Fixture: 21" H | W: 36.25"  
Canopy: 6" Round  
Socket: 9 - E12 Candelabra | Bulb: 9 - 60 C  
\* Custom Height Available (42" Minimum)



D SK5022AI  
Aged Iron





A | **CHC1494AI**  
Aged Iron

A | **FLEMISH MEDIUM ROUND CHANDELIER**  
E. F. CHAPMAN

**CHC1494**  
H: 36.5" | W: 35.5" | Canopy: 5.5" Round  
Socket: 8 - E12 Candelabra | Bulb: 8 - 60 C  
\* Use 40 Bulb Frosted Type "B" with Clip On Shade  
©EFC DESIGNS

opposite page

B | **ERIKA THREE-TIER CHANDELIER**  
THOMAS O'BRIEN

**TOB5206**  
H: 38.75" | W: 39.5" | Canopy: 5" Round  
Socket: 36 - E12 Candelabra | Bulb: 36 - 25 C

C | **ERIKA TWO-TIER CHANDELIER**  
THOMAS O'BRIEN

**TOB5205**  
H: 31" | W: 28.75" | Canopy: 5" Round  
Socket: 24 - E12 Candelabra | Bulb: 24 - 25 C



A | **CHC1494GI**  
Gilded Iron

B | **TOB5206AI**  
Aged Iron



C | **TOB5205BW**  
Belgian White



C | **TOB5205AI**  
Aged Iron



**A** **CHC5370GI**  
Gilded Iron | Antique Mirror

**B** **CHC5373GI**  
Gilded Iron | Antique Mirror

**C** **CHC1474GI-NP**  
Gilded Iron | Antique Mirror | Natural Paper



**D** **CHC5377GI**  
Gilded Iron | Antique Mirror

**A** **GRAMERCY MINI CHANDELIER**  
E. F. CHAPMAN

**CHC5370**  
H: 15.75" | W: 17" | Canopy: 5.75" Round  
Socket: 4 - E12 Candelabra | Bulb: 4 - 60 C  
©EFC DESIGNS

**B** **GRAMERCY MEDIUM CHANDELIER**  
E. F. CHAPMAN

**CHC5373**  
H: 33.75" | W: 32.5" | Canopy: 5.75" Round  
Socket: 6 - E12 Candelabra | Bulb: 6 - 60 C  
©EFC DESIGNS

**C** **GRAMERCY LARGE CHANDELIER**  
E. F. CHAPMAN

**CHC1474**  
H: 34" | W: 41.5" | Canopy: 5.75" Round  
Socket: 8 - E12 Candelabra | Bulb: 8 - 40 B  
©EFC DESIGNS

**D** **GRAMERCY MEDIUM RING CHANDELIER**  
E. F. CHAPMAN

**CHC5377**  
H: 28" | W: 36" | Canopy: 5.75" Round  
Socket: 8 - E12 Candelabra | Bulb: 8 - 40 C  
©EFC DESIGNS



**E** **CHC1543BW-SG**  
Belgian White | Seeded Glass Trim



**F** **CHC1548BW-SG**  
Belgian White | Seeded Glass Trim



**G** **CHC1560BW-SG**  
Belgian White | Seeded Glass Trim



**H** **CHC5445BW**  
Belgian White

**E** **FLANDERS SMALL CHANDELIER**  
E. F. CHAPMAN

**CHC1543**  
H: 24" | W: 26" | Canopy: 5.5" Round  
Socket: 8 - E12 Candelabra | Bulb: 8 - 60 C  
©EFC DESIGNS

**F** **FLANDERS CHANDELIER**  
E. F. CHAPMAN

**CHC1548**  
H: 34" | W: 36.25" | Canopy: 5.5" Round  
Socket: 8 - E12 Candelabra | Bulb: 8 - 60 C  
©EFC DESIGNS

**G** **FLANDERS MEDIUM TWO-TIER CHANDELIER**  
E. F. CHAPMAN

**CHC1560**  
Fixture: 42.5" H | W: 39.5" | Canopy: 7.5" Round  
Socket: 12 - E12 Candelabra | Bulb: 12 - 60 C  
©EFC DESIGNS

**H** **UMBRIA CHANDELIER**  
E. F. CHAPMAN

**CHC5445**  
H: 36.25" | W: 42" | Canopy: 5.75" Round  
Socket: 6 - E12 Candelabra | Bulb: 6 - 40 B  
©EFC DESIGNS



**A** SK5004BW  
Belgian White

**B** SK5003FG  
French Gild

**C** JN5014VW  
Vintage White | Gild

opposite page

**A** MICHELE MEDIUM CHANDELIER  
SUZANNE KASLER

**SK5004**  
H: 38.25" | W: 43" | Canopy: 5.25" Round  
Socket: 6 - E12 Candelabra | Bulb: 6 - 60 C  
**Additional Options:**  
French Gild (FG)

**B** MICHELE CHANDELIER  
SUZANNE KASLER

**SK5003**  
H: 47.5" | W: 46.25" | Canopy: 5" Round  
Socket: 9 - E12 Candelabra | Bulb: 9 - 60 C  
**Additional Options:**  
Belgian White (BW)

**C** FORTUNA LARGE CHANDELIER  
JULIE NEILL

**JN5014**  
H: 43.75" | W: 58.5" | Canopy: 5.5" Round  
Socket: 12 - E12 Candelabra | Bulb: 12 - 40 C

**D** COUNTRY SMALL CHANDELIER  
STUDIO VC

**S5211**  
H: 26.75" | W: 36.5" | Canopy: 5.5" Round  
Socket: 6 - E12 Candelabra | Bulb: 6 - 60 C

**E** COUNTRY LARGE CHANDELIER  
STUDIO VC

**S5212**  
H: 31" | W: 41" | Canopy: 5.5" Round  
Socket: 6 - E12 Candelabra | Bulb: 6 - 60 C

**F** BORDEAUX GRANDE CHANDELIER  
SUZANNE KASLER

**SK5350**  
Fixture: 49.75" H | W: 59.75" | Canopy: 5" Round  
Socket: 12 - E12 Candelabra | Bulb: 12 - 40 C



**D** S5211BW  
Belgian White

**E** S5212BW  
Belgian White



**F** SK5350SWH/NR  
Swedish White | Natural Rust



**A LEAF AND ARROW SMALL CHANDELIER**  
E. F. CHAPMAN

**CHC1448**  
H: 14" | W: 15.5" | Canopy: 5.5" Round  
Socket: 4 - E12 Candelabra | Bulb: 4 - 60 C  
**Additional Options:**  
Bronze and Antique-Burnished Brass (BZ/AB)  
\* CHS104NP Shade Sold Separately  
\* Use 40 Bulb Frosted Type "B" with Clip On Shade  
©EFC DESIGNS

**A CHC1448AB**  
Antique-Burnished Brass

**A CHC1448BZ**  
Bronze

**B LEAF AND ARROW LARGE CHANDELIER**  
E. F. CHAPMAN

**CHC1447**  
H: 21" | W: 34.75" | Canopy: 5.75" Round  
Socket: 8 - E12 Candelabra | Bulb: 8 - 60 C  
**Additional Options:**  
Antique-Burnished Brass (AB)  
Bronze (BZ)  
\* CHS104NP Shade Sold Separately  
\* Use 40 Bulb Frosted Type "B" with Clip On Shade  
©EFC DESIGNS

**C HARLOW MEDIUM CHANDELIER**  
CHRISTOPHER SPITZMILLER

**CS5100**  
H: 31" | W: 22" | Ext: 22"  
Canopy: 6" Round  
Socket: 6 - E12 Candelabra | Bulb: 6 - 40 B  
**Additional Options:** Plaster White (PW)



**C CS5100AI**  
Aged Iron

opposite page

**D MARGARITE IRON CHANDELIER**  
SUZANNE KASLER

**SK5102**  
H: 20.5" | W: 26" | Canopy: 5" Round  
Socket: 7 - E12 Candelabra | Bulb: 7 - 60 C  
\* CHS104NP Shade Sold Separately  
\* Use 40 Bulb Frosted Type "B" with Clip On Shade

**E MARIGOT MEDIUM CHANDELIER**  
E. F. CHAPMAN

**CHC1415**  
H: 30" | W: 33" | Canopy: 5.5" Round  
Socket: 6 - E12 Candelabra | Bulb: 6 - 60 C  
**Additional Options:**  
Rust | Old Brass | Tudor Brown Trim (R)  
©EFC DESIGNS

**F MARIGOT LARGE CHANDELIER**  
E. F. CHAPMAN

**CHC1413**  
H: 36" | W: 44" | Canopy: 5.5" Round  
Socket: 8 - E12 Candelabra | Bulb: 8 - 60 C  
\* CHS104NP Shade Sold Separately  
\* Use 40 Bulb Frosted Type "B" with Clip On Shade  
©EFC DESIGNS



**B CHC1447BZ/AB**  
Bronze | Brass

**G DRESSAGE ROUND CHANDELIER**  
SUZANNE KASLER

**SK5019**  
H: 38" | W: 37.25" | Canopy: 7.5" Round  
Socket: 8 - E12 Candelabra | Bulb: 8 - 60 C

**H DORSET LARGE TORCH CHANDELIER**  
E. F. CHAPMAN

**CHC1462**  
H: 45.5" | W: 57" | Canopy: 5.25" Round  
Socket: 9 - E26 Keyless | Bulb: 9 - 60 A  
\* CHS114NP Shade Sold Separately  
©EFC DESIGNS



**D SK5102GI**  
Gilded Iron



**D SK5102AI**  
Aged Iron



**G SK5019AI**  
Aged Iron | Leather



**E CHC1415AB-SG**  
Antique-Burnished Brass | Seeded Glass Trim



**F CHC1413R**  
Rust | Old Brass | Tudor Brown Trim



**H CHC1462WI**  
Weathered Iron | Antique Gold



**A** **CHC1600PN**  
Polished Nickel



**A** **CHC1600AB**  
Antique-Burnished Brass



**A** **CHC1600BZ**  
Bronze

opposite page

**A** **LAUNCETON SMALL RING CHANDELIER**  
E. F. CHAPMAN

**CHC1600**  
H: 22" | W: 27" | Canopy: 5.25" Round  
Socket: 6 - E12 Candelabra | Bulb: 6 - 60 C  
©EFC DESIGNS  
**Additional Options:**  
Antique Nickel (AN)

**B** **LAUNCETON RING CHANDELIER**  
E. F. CHAPMAN

**CHC1601**  
Fixture: 28.25" H | W: 36" | Canopy: 5" Round  
Socket: 6 - E12 Candelabra | Bulb: 6 - 60 C  
©EFC DESIGNS



**C** **CHC1603PN**  
Polished Nickel



**C** **CHC1603AB**  
Antique-Burnished Brass



**B** **CHC1601AN**  
Antique Nickel



**B** **CHC1601AB**  
Antique-Burnished Brass



**B** **CHC1601BZ**  
Bronze

**C** **LAUNCETON LARGE OVAL CHANDELIER**  
E. F. CHAPMAN

**CHC1603**  
H: 28.25" | W: 39" | Ext: 23.25"  
Canopy: 5.25" Round  
Socket: 6 - E12 Candelabra | Bulb: 6 - 60 C  
©EFC DESIGNS



**C** **CHC1603AN**  
Antique Nickel



**C** **CHC1603BZ**  
Bronze (BZ)



**A** | **CHC5178PN**  
Polished Nickel



**A** | **CHC5178GI**  
Gilded Iron

**A** | **DARLANA MEDIUM TWO-TIER CHANDELIER**  
E. F. CHAPMAN

**CHC5178**  
Fixture: 33" H | W: 30" | Canopy: 6" Round  
Socket: 20 - E12 Candelabra | Bulb: 20 - 40 C  
\* Custom Height Available (41" Minimum)  
©EFC DESIGNS

**B** | **DARLANA EXTRA LARGE TWO-TIER CHANDELIER**  
E. F. CHAPMAN

**CHC5199**  
Fixture: 53.25" H | W: 50" | Canopy: 6" Round  
Socket: 20 - E12 Candelabra | Bulb: 20 - 25 C  
\* Custom Height Available (71" Minimum)  
©EFC DESIGNS



**B** | **CHC5199PN**  
Polished Nickel



**B** | **CHC5199GI**  
Gilded Iron

**C** | **DARLANA LARGE TWO-TIER RING CHANDELIER**  
E. F. CHAPMAN

**CHC5179**  
H: 33" | W: 40" | Canopy: 6" Round  
Socket: 20 - E12 Candelabra | Bulb: 20 - 40 C  
**Additional Options:**  
Gilded Iron (GI)  
Polished Nickel (PN)  
©EFC DESIGNS

**D** | **BRITTANY CHANDELIER**  
NIERMANN WEEKS

**NW5011**  
H: 37.25" | W: 37.25" | Canopy: 6" Round  
Socket: 16 - E12 Candelabra | Bulb: 16 - 40 C

opposite page



**C** | **CHC5179AI**  
Aged Iron



**D** | **NW5011VS**  
Venetian Silver



**D** | **NW5011VG**  
Venetian Gold



**A** | **S5315GI-NP**  
Gilded Iron | Natural Paper



**A** | **S5315BR-NP**  
Black Rust | Natural Paper

**A** | **ETOILE ROUND CHANDELIER**  
IAN K. FOWLER

**S5315**  
H: 64.5" | Fixture: 25.5" | W: 35.5"  
Canopy: 5.5" Round  
Socket: 4 - E12 Candelabra | Bulb: 4 - 60 B  
Shade: 4.5" x 5.5" x 6.5"

**B** | **CLASSIC RING CHANDELIER**  
E. F. CHAPMAN

**SL5812**  
Fixture: 28" H | W: 33.25"  
Canopy: 5.5" Round  
Socket: 6 - E12 Candelabra | Bulb: 6 - 40 B  
Shade: 3" x 6.5" x 5"  
©EFC DESIGNS

opposite page

**C** | **CLASSIC TWO-TIER RING CHANDELIER**  
E. F. CHAPMAN

**SL5813**  
Fixture: 47" H | W: 45" | Canopy: 5.5" Round  
Socket: 9 - E12 Candelabra | Bulb: 9 - 40 B  
Shade: 3" x 6" x 5"  
©EFC DESIGNS

**D** | **CLASSIC MINI RING CHANDELIER**  
E. F. CHAPMAN

**SL5814**  
H: 38" | Fixture: 32" H | W: 25.5"  
Canopy: 5.5" Round  
Socket: 6 - E12 Candelabra | Bulb: 6 - 40 B  
Shade: 3" x 6.5" x 5"  
©EFC DESIGNS

**Additional Options for Classic Ring:**  
Antique Nickel | Natural Paper (AN-NP)  
Bronze | Natural Paper (BZ-NP)  
Hand-Rubbed Antique Brass | Natural Paper (HAB-NP)  
Polished Nickel | Natural Paper (PN-NP)



**B** | **SL5812PN-NP**  
Polished Nickel | Natural Paper



**B** | **SL5812HAB-NP**  
Hand-Rubbed Antique Brass | Natural Paper



**C** | **SL5813BZ-NP**  
Bronze | Natural Paper



**D** | **SL5814PN-NP**  
Polished Nickel | Natural Paper



**D** | **SL5814HAB-NP**  
Hand-Rubbed Antique Brass | Natural Paper



**D** | **SL5814AN-NP**  
Antique Nickel | Natural Paper



**D** | **SL5814BZ-NP**  
Bronze | Natural Paper



**A** | **SP5014PN-NP**  
Polished Nickel | Natural Paper

**A** | **SP5014HAB-NP**  
Hand-Rubbed Antique Brass | Natural Paper

**A** | **SP5014BZ-NP**  
Bronze | Natural Paper

opposite page

**A** | **HACKNEY LARGE CHANDELIER**  
J. RANDALL POWERS

**SP5014**  
H: 63" | Fixture: 37.75" H | W: 43.25"  
Canopy: 4" Round  
Socket: 9 - E12 Candelabra | Bulb: 9 - 25 B  
Shade: 2.5" x 9" x 5"  
\* Custom Height Available (50" Minimum)



**B** | **TOB5024PN-NP**  
Polished Nickel | Natural Paper

**B** | **TOB5024HAB-NP**  
Hand-Rubbed Antique Brass | Natural Paper



**B** | **TOB5024AN-NP**  
Antique Nickel | Natural Paper

**B** | **TOB5024BZ-NP**  
Bronze | Natural Paper

**B** | **BRYANT LARGE RING CHANDELIER**  
THOMAS O'BRIEN

**TOB5024**  
O/A H: 34" | Fixture: 19.25" H | W: 42"  
Canopy: 7" Round  
Socket: 8 - E26 Keyless | Bulb: 8 - 40 A  
\* Cannot Be Modified in the Field  
\* Custom Height Available (31" Minimum)





**A** **CHC1554OW-NP**  
Old White | Glass | Natural Paper

**A** **MONTMARTE IRON CHANDELIER**  
E. F. CHAPMAN

**CHC1554**  
H: 44" | W: 33.75" | Canopy: 5.75" Round  
Socket: 8 - E12 Candelabra | Bulb: 8 - 40 B  
Shade: 4" x 5.5" x 5"  
©EFC DESIGNS



**B** **TOB5119BSL-NP**  
Burnished Silver Leaf | Natural Paper

**B** **TOB5119HAB-NP**  
Hand-Rubbed Antique Brass | Natural Paper

**B** **TOB5119BR/HAB-NP**  
Blackened Rust | Brass | Natural Paper

opposite page

**B** **CHANNING SMALL CHANDELIER**  
THOMAS O'BRIEN

**TOB5119**  
H: 18.5" | W: 28" | Canopy: 6" Round  
Socket: 6 - E12 Candelabra | Bulb: 6 - 60 B  
Shade: 4.5" x 6" x 5.5"

**C** **BELVEDERE MEDIUM CHANDELIER**  
E. F. CHAPMAN

**CHC1403**  
H: 53.75" | W: 32.5" | Canopy: 5.75" Round  
Socket: 9 - E12 Candelabra | Bulb: 9 - 40 B  
Shade: 4" x 6" x 5"  
©EFC DESIGNS

**D** **LANCASTER CHANDELIER**  
E. F. CHAPMAN

**CHC1577**  
H: 58" | W: 41.5" | Canopy: 5.75" Round  
Socket: 8 - E12 Candelabra | Bulb: 8 - 40 B  
Shade: 4" x 5.5" x 5"  
**Additional Options:**  
Old White | Natural Paper (OW-NP)  
©EFC DESIGNS



**C** **CHC1403GI-NP**  
Gilded Iron | Natural Paper

**C** **CHC1403AI-NP**  
Aged Iron | Natural Paper

**D** **CHC1577GI-NP**  
Gilded Iron | Natural Paper

**D** **CHC1577AI-NP**  
Aged Iron | Natural Paper



**A** | **CHC2461PN-NP**  
Polished Nickel | Natural Paper

**A** | **CHC2461AN-NP**  
Antique Nickel | Natural Paper

**A** | **CHC2461AB-NP**  
Antique-Burnished Brass | Natural Paper

**A** | **CHC2461BZ-NP**  
Bronze | Natural Paper



**B** | **CHC2462AN-NP**  
Antique Nickel | Natural Paper

**B** | **CHC2462AB-NP**  
Antique-Burnished Brass | Natural Paper

**B** | **CHC2462BZ-NP**  
Bronze | Natural Paper



**B** | **CHC2462PN-NP**  
Polished Nickel | Natural Paper

**A** | **RUHLMANN SMALL CHANDELIER**  
E. F. CHAPMAN  
  
**CHC2461**  
H: 17.5" | W: 17.5" | Canopy: 5.5" Round  
Socket: 3 - E12 Candelabra | Bulb: 3 - 40 B  
Shade: 3" x 4" x 4"  
©EFC DESIGNS

**B** | **RUHLMANN LARGE CHANDELIER**  
E. F. CHAPMAN  
  
**CHC2462**  
H: 24.25" | W: 35.25" | Canopy: 5.5" Round  
Socket: 6 - E26 Keyless | Bulb: 6 - 60 B  
Shade: 4" x 5" x 6.5"  
©EFC DESIGNS

**C** | **RUHLMANN TWO-TIER CHANDELIER**  
E. F. CHAPMAN  
  
**CHC2465**  
H: 31.75" | W: 35" | Canopy: 5.5" Round  
Socket: 9 - E12 Candelabra | Bulb: 9 - 60 B  
Shade: 4" x 5" x 6.5"  
**Additional Options:**  
Antique Nickel | Natural Paper (AN-NP)  
Bronze | Natural Paper (BZ-NP)  
Polished Nickel | Natural Paper (PN-NP)  
©EFC DESIGNS



**C** | **CHC2465AB-NP**  
Antique-Burnished Brass | Natural Paper

**A** **TUILERIES CHANDELIER**  
**AERIN**  
**ARN5112**  
 Fixture: 21.5" H | W: 36" | Canopy: 5.5" Round  
 Socket: 8 - E12 Candelabra | Bulb: 8 - 60 B  
 Shade: 5" x 6.5" x 6.5"

**B** **MYRNA CHANDELIER**  
**ALEXA HAMPTON**  
**AH5010**  
 H: 21" | W: 33" | Canopy: 4.5" Round  
 Socket: 6 - E12 Candelabra | Bulb: 6 - 40 B  
 Shade: 3" x 6.5" x 5"



**B** **AH5010NB-NP**  
 Natural Brass | Natural Paper



**A** **ARN5112PN-L**  
 Polished Nickel | Linen



**A** **ARN5112HAB-L**  
 Hand-Rubbed Antique Brass | Linen



**B** **AH5010PN-NP**  
 Polished Nickel | Natural Paper



**B** **AH5010GM-NP**  
 Gun Metal | Natural Paper



**A** **TOB5018PS-NP**  
Polished Silver | Natural Paper



**A** **TOB5018AN-NP**  
Antique Nickel | Natural Paper



**A** **TOB5018HAB-NP**  
Hand-Rubbed Antique Brass | Natural Paper



**A** **TOB5018BZ/HAB-NP**  
Bronze | Brass | Natural Paper

**A FARLANE SMALL CHANDELIER**  
THOMAS O'BRIEN

**TOB5018**  
O/A H: 61.25" | Fixture: 24.25" H | W: 34"  
Canopy: 5.75" Round  
Socket: 6 - E12 Candelabra | Bulb: 6 - 40 B  
Shade: 3" x 5" x 7"  
\* Slope Mount Included  
\* Custom Height Available (30" Minimum)

**B FARLANE LARGE CHANDELIER**  
THOMAS O'BRIEN

**TOB5017**  
O/A H: 61.25" | W: 48" | Canopy: 5.75" Round  
Socket: 12 - E12 Candelabra | Bulb: 12 - 40 B  
Shade: 3" x 5" x 7"  
\* Slope Mount Included  
\* Custom Height Available (34" Minimum)

**Additional Options for Farlane:**  
Antique Nickel | Natural Paper | Red Tape (AN-NP/RT)  
Bronze | Brass | Natural Paper (BZ/HAB-NP)  
Hand-Rubbed Antique Brass | Natural Paper (HAB-NP)  
Polished Silver | Natural Paper (PS-NP)



**B** **TOB5017BZ/HAB-NP**  
Bronze | Brass | Natural Paper



**A** **TOB5009PN-NP** Polished Nickel | Natural Paper  
**A** **TOB5009AN-NP** Antique Nickel | Natural Paper  
**A** **TOB5009HAB-NP** Hand-Rubbed Antique Brass | Natural Paper  
**A** **TOB5009BZ-NP** Bronze | Natural Paper



**B** **TOB5010PN-NP** Polished Nickel | Natural Paper  
**B** **TOB5010HAB-NP** Hand-Rubbed Antique Brass | Natural Paper  
**B** **TOB5010BZ-NP** Bronze | Natural Paper

opposite page

**A REED SMALL CHANDELIER**  
THOMAS O'BRIEN

**TOB5009**  
H: 30" | W: 20" | Canopy: 5.25" Round  
Socket: 3 - E12 Candelabra | Bulb: 3 - 60 B  
Shade: 4" x 5" x 5.75"  
\* Height Cannot Be Modified in the Field  
\* Custom Height Available (20" Minimum)

**B REED LARGE CHANDELIER**  
THOMAS O'BRIEN

**TOB5010**  
H: 37.5" | W: 26.5" | Canopy: 5.25" Round  
Socket: 8 - E12 Candelabra | Bulb: 8 - 60 B  
Shade: 4" x 5" x 5.75"  
\* Height Cannot Be Modified in the Field  
\* Custom Height Available (30" Minimum)

**Available Options for Reed:**  
Antique Nickel | Natural Paper (AN-NP)  
Bronze | Natural Paper (BZ-NP)  
Hand-Rubbed Antique Brass | Natural Paper (HAB-NP)  
Polished Nickel | Natural Paper (PN-NP)



**C REED EXTRA LARGE CHANDELIER**  
THOMAS O'BRIEN

**TOB5019**  
H: 35" | W: 33" | Canopy: 5.25" Round  
Socket: 16 - E12 Candelabra | Bulb: 16 - 25 B  
Shade: 4" x 5" x 5.75"

**C** **TOB5019PN-NP** Polished Nickel | Natural Paper  
**C** **TOB5019BZ-NP** Bronze | Natural Paper



**A** | **TOB5007BZ-NP**  
Bronze | Natural Paper

**A** | **TOB5007HAB-NP**  
Hand-Rubbed Antique Brass | Natural Paper

**A** | **TOB5007AS-NP**  
Antique Silver | Natural Paper

**A** | **TOB5007PN-NP**  
Polished Nickel | Natural Paper



**B** | **TOB5008HAB-NP**  
Hand-Rubbed Antique Brass | Natural Paper



**B** | **TOB5008AS-NP**  
Antique Silver | Natural Paper



**B** | **TOB5008BZ-NP**  
Bronze | Natural Paper

**A** | **VENDOME SMALL CHANDELIER**  
THOMAS O'BRIEN

**TOB5007**  
O/A H: 42.75" | W: 26" | Canopy: 5.25" Round  
Socket: 4 - E12 Candelabra | Bulb: 4 - 60 B  
Shade: 4" x 5.5" x 6" Candle Clip  
**Additional Options:**  
Brass | Natural Paper | Black Tape (HAB-NP/BT)  
\* Slope Mount Included  
\* Custom Height Available (26" Minimum)

**B** | **VENDOME LARGE CHANDELIER**  
THOMAS O'BRIEN

**TOB5008**  
O/A H: 43" | W: 34" | Canopy: 5.25" Round  
Socket: 8 - E12 Candelabra | Bulb: 8 - 60 B  
Shade: 4" x 5.5" x 6"  
\* Slope Mount Included  
\* Custom Height Available (27" Minimum)



**B** | **BBL5081G-S**  
Gilded | Silk

**A** | **GO LIGHTLY SMALL CHANDELIER**  
BARBARA BARRY  
  
**BBL5080**  
H: 14" | W: 19.75" | Canopy: 4.5" Round  
Socket: 4 - E12 Candelabra | Bulb: 4 - 40 B  
Shade: 5.5" x 6" x 7"



**A** | **BBL5080CW-S**  
China White | Silk

**A** | **BBL5080G-S**  
Gilded | Silk

**A** | **BBL5080C-S**  
Charcoal | Silk

**B** | **GO LIGHTLY MEDIUM CHANDELIER**  
BARBARA BARRY  
  
**BBL5081**  
H: 24.75" | W: 31" | Canopy: 4.5" Round  
Socket: 8 - E12 Candelabra | Bulb: 8 - 40 B  
Shade: 5.5" x 6" x 7"



**B** | **BBL5081CW-S**  
China White | Silk

**B** | **BBL5081G-S**  
China White | Silk

**B** | **BBL5081C-S**  
Charcoal | Silk



**A** TOB5002PN-NP  
Polished Nickel | Natural Paper

**A** TOB5002AN-NP  
Antique Nickel | Natural Paper

**A** TOB5002HAB-NP  
Hand-Rubbed Antique Brass | Natural Paper

**A** TOB5002BZ-NP  
Bronze | Natural Paper



**B** TOB5003PN-NP  
Polished Nickel | Natural Paper

**B** TOB5003HAB-NP  
Hand-Rubbed Antique Brass | Natural Paper

**B** TOB5003BZ-NP  
Bronze | Natural Paper

**A** BRYANT SMALL CHANDELIER  
THOMAS O'BRIEN

**TOB5002**  
H: 48" | W: 26" | Canopy: 7" Round  
Socket: 4 - E26 Keyless | Bulb: 4 - 60 A  
Shade: 4" x 5.5" x 6"  
\* Slope Mount Included  
\* Custom Height Available (28" Minimum)

**B** BRYANT LARGE CHANDELIER  
THOMAS O'BRIEN

**TOB5003**  
H: 48" | W: 36" | Canopy: 7" Round  
Socket: 4 - E26 Keyless | Bulb: 4 - 60 A  
Shade: 4" x 5.5" x 6"  
**Additional Options:**  
Antique Nickel | Natural Paper (AN-NP)  
\* Slope Mount Included  
\* Custom Height Available (28" Minimum)

**B** TOB5003PN-NP  
Polished Nickel | Natural Paper







**A** SK5050PN-NP  
Polished Nickel | Natural Paper



**A** SK5050HAB-NP  
Hand-Rubbed Antique Brass | Natural Paper

**A** **CAMILLE SMALL CHANDELIER**  
SUZANNE KASLER

**SK5050**  
H: 25.5" | W: 27.25" | Canopy: 4.25" Round  
Socket: 4 - E12 Candelabra | Bulb: 4 - 40 B  
Shade: 4" x 5.5" x 6"  
**Additional Options:**  
Bronze | Natural Paper (BZ-NP)

**B** **GRENOL MEDIUM MODERN BAMBOO CHANDELIER**  
STUDIO VC

**S5161**  
H: 31.75" | W: 33.25" | Canopy: 5" Round  
Socket: 6 - E12 Candelabra | Bulb: 6 - 40 B  
Shade: 4" x 5" x 6.75"  
**Additional Options:**  
Bronze | Percalé (BZ-PL)



**C** TOB5046PN-NP  
Polished Nickel | Natural Paper



**C** TOB5046HAB-NP  
Hand-Rubbed Antique Brass | Natural Paper



**C** TOB5046BZ/HAB-NP  
Bronze | Brass | Natural Paper



**B** S5161PN-PL  
Polished Nickel | Percalé



**B** S5161HAB-PL  
Hand-Rubbed Antique Brass | Percalé

opposite page

**C** **CARON LARGE CHANDELIER**  
THOMAS O'BRIEN

**TOB5046**  
H: 40" | Fixture: 16" H | W: 30"  
Canopy: 4.75" Round  
Socket: 8 - E12 Candelabra | Bulb: 8 - 60 C  
Shade: 4" x 5" x 6.5"  
\* Custom Height Available (21" Minimum)

**D** **ZIYI LARGE CHANDELIER**  
THOMAS O'BRIEN

**TOB5016**  
H: 44.5" | W: 33.5" | Canopy: 4.25" Round  
Socket: 8 - E12 Candelabra | Bulb: 8 - 25 B  
Shade: 4" x 4" x 9.5"  
\* Custom Height Available (32" Minimum)



**D** TOB5016PN-NP  
Polished Nickel | Natural Paper



**D** TOB5016HAB-NP  
Hand-Rubbed Antique Brass | Natural Paper



**D** TOB5016BZ-NP  
Bronze | Natural Paper



**A** **TOB5451SG-L**  
Swedish Gray | Linen



**A** **TOB5451AI/EBO-L**  
Aged Iron | Ebonized Oak | Linen



**B** **TOB5452SG-L**  
Swedish Gray | Linen



**B** **TOB5452AI/EBO-L**  
Aged Iron | Ebonized Oak | Linen

opposite page

**A** **PIAF LARGE CHANDELIER**  
THOMAS O'BRIEN

**TOB5451**  
H: 56.75" | Fixture: 18.25" H | W: 39.25"  
Canopy: 4.75" Round  
Socket: 4 - E12 Candelabra | Bulb: 4 - 40 B  
Shade: 2.5" x 6.5" x 5.5"

**B** **PIAF GRANDE CHANDELIER**  
THOMAS O'BRIEN

**TOB5452**  
H: 56.75" | Fixture: 18.25" H | W: 58"  
Canopy: 4.75" Round  
Socket: 6 - E12 Candelabra | Bulb: 6 - 40 B  
Shade: 2.5" x 6.5" x 5.5"



**C** **CHC5315AI-L**  
Aged Iron | Linen

**C** **GABRIEL MEDIUM CHANDELIER**  
E. F. CHAPMAN

**CHC5315**  
H: 22.5" | W: 35" | Canopy: 5.5" Round  
Socket: 6 - E12 Candelabra | Bulb: 6 - 40 B  
Shade: 3.5" x 5" x 8"  
**Additional Options:**  
Plaster White | Linen (PW-L)  
©EFC DESIGNS

**D** **PIETRO SMALL CHANDELIER**  
THOMAS O'BRIEN

**TOB5750**  
H: 34" | W: 33" | Canopy: 5.75" Round  
Socket: 4 - E12 Candelabra | Bulb: 4 - 40 B  
Shade: 4.5" x 5" x 6.5"

**E** **PIETRO GRANDE TWO TIER CHANDELIER**  
THOMAS O'BRIEN

**TOB5760**  
H: 42" | W: 45" | Canopy: 5.75" Round  
Socket: 12 - E12 Candelabra | Bulb: 12 - 40 B  
Shade: 4.5" x 5" x 6.5"



**D** **TOB5750AI-L**  
Aged Iron | Linen



**E** **TOB5760AI-L**  
Aged Iron | Linen



A | ARN5036HAB-L  
Hand-Rubbed Antique Brass | Linen



A | ARN5036PN-L  
Polished Nickel | Linen



A | ARN5036HAB-L  
Hand-Rubbed Antique Brass | Linen

**A CLARKSON CHANDELIER**  
AERIN

**ARN5036**  
H: 58" | Fixture: 31.5" H | W: 35.75"  
Canopy: 4.5" Round  
Socket: 10 - E12 Candelabra | Bulb: 10 - 60 C  
Shade: 3.75" x 6.75" x 7.5"  
\* Custom Height Available (41" Minimum)

**B DRUNMORE LARGE CHANDELIER**  
AERIN

**ARN5018**  
Fixture: 26" H | W: 32.5" | Canopy: 5" Round  
Socket: 8 - E12 Candelabra | Bulb: 8 - 25 B  
Shade: 4.5" x 4.5" x 8.5"



B | ARN5018PN/CG-L  
Polished Nickel | Crystal | Linen



B | ARN5018HAB/CG-L  
Hand-Rubbed Antique Brass | Crystal | Linen



B | ARN5018BZ/CG-L  
Bronze | Crystal | Linen



**A** | **KS5070BSL-L**  
Burnished Silver Leaf | Cream Linen



**A** | **KS5070G-L/BL**  
Gild | Cream Linen | Black Linen



**B** | **NW5070BSL-L**  
Burnished Silver Leaf | Linen



**B** | **NW5070GI-L**  
Gilded Iron | Linen

**A** | **WALKER MEDIUM TWO TIER CHANDELIER**  
KATE SPADE NEW YORK

**KS5070**  
H: 54.75" | Fixture: 20.25" H | W: 41"  
Canopy: 4.5" Round  
Socket: 6 - E12 Candelabra | Bulb: 6 - 60 G  
Shade: 10" x 10" x 5.5"

**B** | **KELLEY LARGE CHANDELIER**  
NIERMANN WEEKS

**NW5070**  
H: 56" | Fixture: 20.25" H | W: 43.75"  
Canopy: 4.75" Round  
Socket: 9 - E12 Candelabra | Bulb: 9 - 40 B  
Shade: 4" x 12" x 6.75"



**C** | **ARN5052G-L**  
Gild | Linen

**C** | **MONTREUIL CHANDELIER**  
AERIN

**ARN5052**  
Fixture: 33.25" H | W: 34.5" | Canopy: 7" Round  
Socket: 10 - E12 Candelabra | Bulb: 10 - 60 B  
Shade: 2.5" x 5" x 8"



**C** | **ARN5052BSL-L**  
Burnished Silver Leaf | Linen

**A FONTAINE MEDIUM TIERED CHANDELIER**  
AERIN

**ARN5204**

H: 45.25" | W: 34.25" | Canopy: 5" Round  
Socket: 8 - E12 Candelabra | Bulb: 8 - 40 B  
Shade: 3" x 5.5" x 9.5"

**B FONTAINE LARGE OFFSET CHANDELIER**  
AERIN

**ARN5205**

Fixture: 33.5" H | W: 39" | Canopy: 5" Round  
Socket: 8 - E12 Candelabra | Bulb: 8 - 40 B  
Shade: 3" x 5.5" x 9.5"

**Additional Options:**

Aged Iron | Linen (AI-L)



**A** | **ARN5204AI-L**  
Aged Iron | Linen



**A** | **ARN5204PL-L**  
Plaster | Linen

**A** | **ARN5204GP-L**  
Gilded Plaster | Linen

**B** | **ARN5205PL-L**  
Plaster White | Linen

**B** | **ARN5205GP-L**  
Gilded Plaster | Linen



**A** | **JN5003PW**  
Plaster White



**A** | **JN5003BSL**  
Burnished Silver Leaf



**B** | **JN5004PW**  
Plaster White



**B** | **JN5004AGL**  
Antique Gold Leaf



**C** | **JN5006AGL**  
Antique Gold Leaf

**C** | **JN5005PW**  
Plaster White



**A** | **ALBERTO SMALL SINGLE TIER CHANDELIER**  
JULIE NEILL

**JN5003**  
H: 34.5" | W: 30" | Canopy: 5.5" Round  
Socket: 6 - E12 Candelabra | Bulb: 6 - 60 G  
**Additional Options:**  
Antique Gold Leaf (AGL)

**B** | **ALBERTO LARGE SINGLE TIER CHANDELIER**  
JULIE NEILL

**JN5004**  
H: 46" | W: 40" | Canopy: 5.5" Round  
Socket: 6 - E12 Candelabra | Bulb: 6 - 60 G  
**Additional Options:**  
Burnished Silver Leaf (BSL)

**C** | **ALBERTO LARGE TWO TIER CHANDELIER**  
JULIE NEILL

**JN5006**  
H: 58.5" | W: 49" | Canopy: 5.5" Round  
Socket: 8 - E12 Candelabra | Bulb: 8 - 60 G  
**Additional Options:**  
Burnished Silver Leaf (BSL)



**A** | **ARN5401PN-WG**  
Polished Nickel | Strie Glass



**A** | **ARN5401HAB-WG**  
Hand-Rubbed Antique Brass | Strie Glass



**A** | **ARN5401HAB-WG**  
Hand-Rubbed Antique Brass | Strie Glass

opposite page

**A** | **CRISTOL MEDIUM CHANDELIER**  
AERIN

**ARN5401**  
O/A H: 46.25" | Fixture: 23.25" H | W: 28"  
Canopy: 6" Round  
Socket: 10 - E12 Candelabra | Bulb: 10 - 40 B  
\* Custom Height Available (26" Minimum)



**B** | **ARN5402PN-WG**  
Polished Nickel | Strie Glass



**B** | **ARN5402HAB-WG**  
Hand-Rubbed Antique Brass | Strie Glass

**B** | **CRISTOL LARGE CHANDELIER**  
AERIN

**ARN5402**  
O/A H: 62" | Fixture: 33" H | W: 33.25"  
Canopy: 6" Round  
Socket: 17 - E12 Candelabra | Bulb: 17 - 25 B  
\* Custom Height Available (41" Minimum)



**C** | **ARN5450PN-WSG**  
Polished Nickel | White Strie Glass



**C** | **ARN5450G-WSG**  
Gild | White Strie Glass

**C** | **LOIRE LARGE CHANDELIER**  
AERIN

**ARN5450**  
H: 55" | Fixture: 20" H | W: 37.25"  
Canopy: 4.25" Round  
Socket: 9 - E12 Candelabra | Bulb: 9 - 40 C



**A** | **S5022HAB-WG**  
Hand-Rubbed Antique Brass | White Glass

**A** | **BISTRO TIERED CHANDELIER**  
IAN K. FOWLER

**S5022**  
H: 60" | Fixture: 29" H | W: 47"  
Canopy: 4.5" Round  
Socket: 12 - E12 Candelabra | Bulb: 12 - 40 B  
**Additional Options:**  
Polished Nickel | Clear Glass (PN-CG)  
\* Custom Height Available (38" Minimum)



**B** | **S5270PN-CG**  
Polished Nickel | Clear Glass

**B** | **S5270HAB/BLK-WG**  
Black | Brass | White Glass

**D** | **S5024PN/BLK-CG**  
Black | Nickel | Clear Glass

opposite page

**B** | **BISTRO SMALL CHANDELIER**  
IAN K. FOWLER

**S5270**  
O/A H: 53" | Fixture: 20.5" H | W: 22.5"  
Canopy: 4.5" Round  
Socket: 12 - E12 Candelabra | Bulb: 12 - 40 G  
\* Custom Height Available (33" Minimum)

**C** | **BISTRO MEDIUM CHANDELIER**  
IAN K. FOWLER

**S5271**  
H: 59.5" | Fixture: 32" H | W: 32"  
Canopy: 4.5" Round  
Socket: 18 - E12 Candelabra | Bulb: 18 - 40 G  
\* Custom Height Available (44" Minimum)

**D** | **BISTRO OBLONG CHANDELIER**  
IAN K. FOWLER

**S5024**  
O/A H: 66" | Fixture: 27" H | W: 53"  
Canopy: 4.5" Round  
Socket: 14 - E12 Candelabra | Bulb: 14 - 40 G  
**Additional Options:**  
Polished Nickel | Clear Glass (PN-CG)  
\* Custom Height Available (34" Minimum)



**C** | **S5271PN-CG**  
Polished Nickel | Clear Glass

**C** | **S5271HAB/BLK-WG**  
Black | Brass | White Glass

**D** | **S5024HAB/BLK-WG**  
Black | Brass | White Glass



**A** PRESCOTT MEDIUM MOBILE CHANDELIER  
kate spade new york

**KS5403**  
H: 35.75" | Fixture: 22.5" H | W: 40"  
Canopy: 7.5" Round  
Socket: 5 - E12 Candelabra | Bulb: 5 - 40 G  
**Additional Options:**  
Polished Nickel | White Glass (PN-WG)  
Soft Brass | Clear Glass (SB-CG)  
\* Custom Height Available (25" Minimum)

**B** PRESCOTT LARGE MOBILE CHANDELIER  
KATE SPADE NEW YORK

**KS5404**  
O/A H: 58.25" | Fixture: 42.75" H | W: 55"  
Canopy: 10" Round  
Socket: 7 - E12 Candelabra | Bulb: 7 - 40 G  
**Additional Options:**  
Polished Nickel | Clear Glass (PN-CG)  
Soft Brass | Clear Glass (SB-CG)  
\* Custom Height Available (48" Minimum)



**A** | **KS5403PN-CG**  
Polished Nickel | Clear Glass

**A** | **KS5403SB-WG**  
Soft Brass | White Glass



**B** | **KS5404PN-CG**  
Polished Nickel | Clear Glass

**B** | **KS5404SB-WG**  
Soft Brass | White Glass



**A** | **KS5403SB-CG**  
Soft Brass | Clear Glass



**C** | **ARN5262PN-CG**  
Polished Nickel | Clear Glass



**C** | **ARN5262HAB-CG**  
Hand-Rubbed Antique Brass | Clear Glass

opposite page

**C** TURENNE LARGE DYNAMIC CHANDELIER  
AERIN

**ARN5262**  
H: 45" | Fixture: 19.5" H | W: 33.5"  
Canopy: 4.25" Round  
Socket: 6 - E12 Candelabra | Bulb: 6 - 40 B  
\* UL Only  
\* Cannot Be Modified in the Field  
\* Custom Height Available (31" Minimum)



**A** | **ARN5009HAB-BLK**  
Hand-Rubbed Antique Brass | Black

**A** | **SOMMERARD LARGE TRIPLE ARM CHANDELIER**  
AERIN

**ARN5009**  
H: 57" | Fixture: 17.5" H | W: 62"  
Canopy: 5.5" Round  
Socket: 3 - E26 Keyless | Bulb: 3 - 60 A  
**Additional Options:**  
Hand-Rubbed Antique Brass | White (HAB-WHT)  
\* Custom Height Available (28" Minimum)

**B** | **SOMMERARD MEDIUM TRIPLE ARM CHANDELIER**  
AERIN

**ARN5008**  
O/A H: 53.5" | Fixture: 10" H | W: 50"  
Canopy: 5.5" Round  
Socket: 3 - E26 Keyless | Bulb: 3 - 40 A  
\* Cannot Be Modified in the Field  
\* Custom Height Available (23" Minimum)

**C** | **SOMMERARD MEDIUM FIVE-LIGHT CHANDELIER**  
AERIN

**ARN5010**  
H: 70.25" | Fixture: 35.5" H | W: 46"  
Canopy: 5.5" Round  
Socket: 5 - E26 Keyless | Bulb: 5 - 60 A

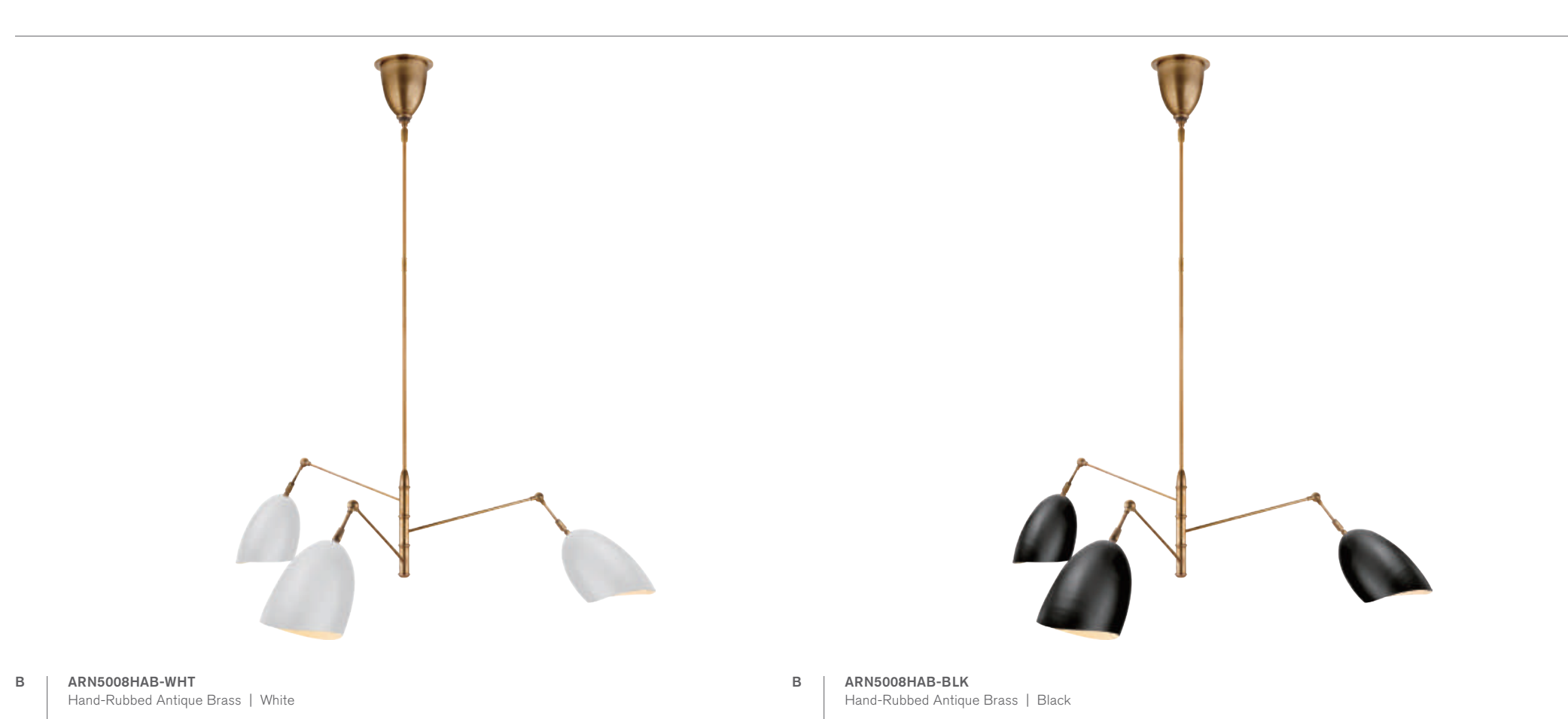

**B** | **ARN5008HAB-WHT**  
Hand-Rubbed Antique Brass | White

**B** | **ARN5008HAB-BLK**  
Hand-Rubbed Antique Brass | Black



**C** | **ARN5010HAB-WHT**  
Hand-Rubbed Antique Brass | White

**C** | **ARN5010HAB-BLK**  
Hand-Rubbed Antique Brass | Black



**A** | **ARN5006WHT**  
White

**A** | **ARN5006HAB**  
Hand-Rubbed Antique Brass

opposite page

**A** | **CHARLTON LARGE TRIPLE ARM CHANDELIER**  
AERIN

**ARN5006**  
H: 47" | Fixture: 11.25" H | W: 55.25"  
Canopy: 5.25" Round  
Socket: 3 - E26 Keyless | Bulb: 3 - 40 A  
**Additional Options:**  
Black (BLK)

**B** | **CHARLTON GRANDE TRIPLE ARM CHANDELIER**  
AERIN

**ARN5007**  
H: 46" | Fixture: 10.5" H | W: 96"  
Canopy: 5.25" Round  
Socket: 3 - E26 Keyless | Bulb: 3 - 40 A  
**Additional Options:**  
Hand-Rubbed Antique Brass (HAB)  
White (WHT)



**C** | **ARN5501HAB-WHT**  
Hand-Rubbed Antique Brass | White

**C** | **ARN5501HAB-BLK**  
Hand-Rubbed Antique Brass | Black

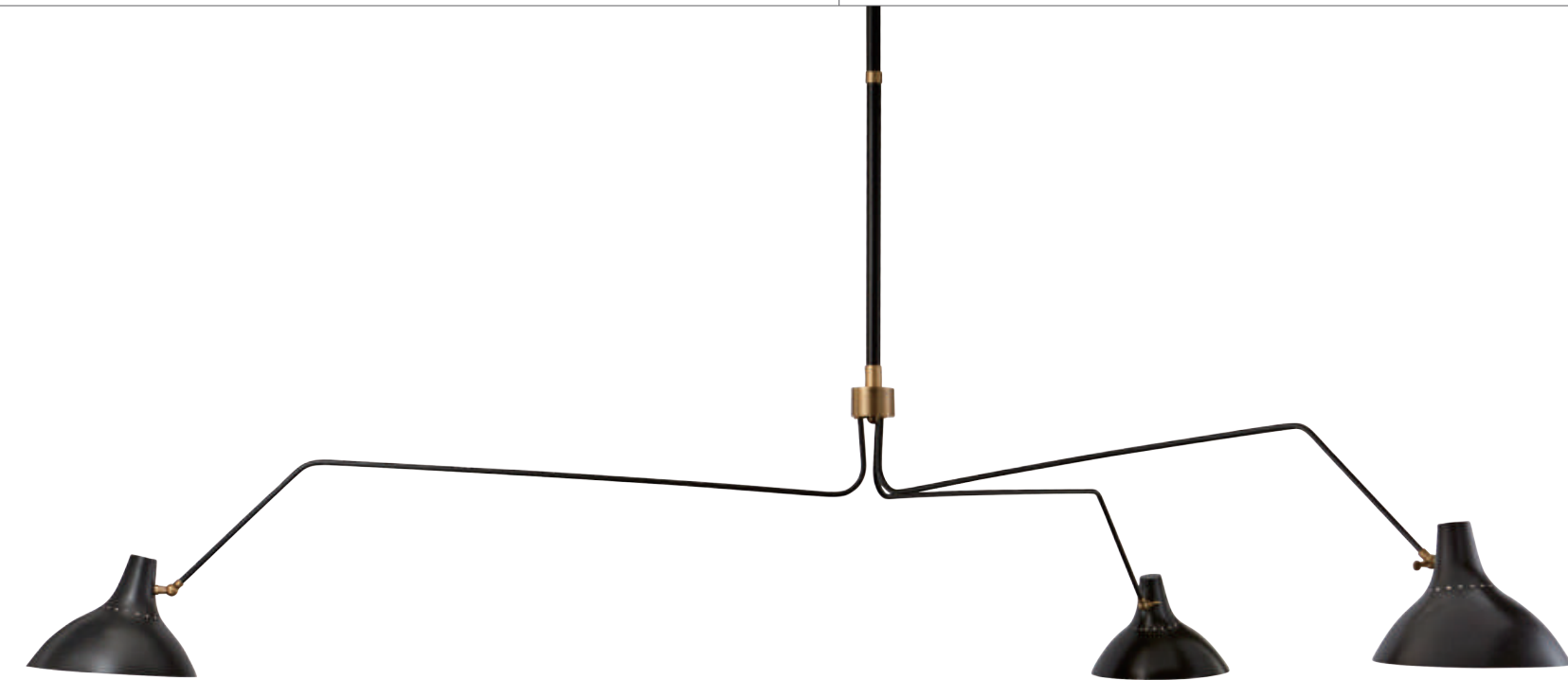

**B** | **ARN5007BLK**  
Black

**C** | **GRAPHIC LARGE TWO-TIER CHANDELIER**  
AERIN

**ARN5501**  
H: 51.5" | Fixture: 12.25" H | W: 38"  
Canopy: 5.5" Round  
Socket: 8 - E12 Candelabra | Bulb: 8 - 40 B  
\* Custom Height Available (24" Minimum)

**D** | **GRAPHIC GRANDE FOUR-TIER CHANDELIER**  
AERIN

**ARN5503**  
H: 69.75" | Fixture: 28.25" H | W: 73"  
Canopy: 7.75" Round  
Socket: 16 - E12 Keyless | Bulb: 16 - 40 B  
**Additional Options:**  
Hand-Rubbed Antique Brass | White (HAB-WHT)



**D** | **ARN5503HAB-BLK**  
Hand-Rubbed Antique Brass | Black

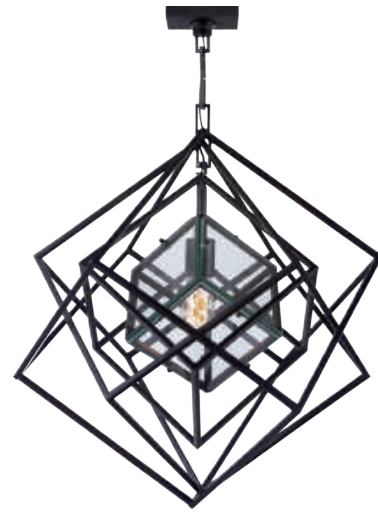

**A** | **KW5020G-CG**  
Gild | Clear Glass

**A** | **KW5020AI-CG**  
Aged Iron | Clear Glass

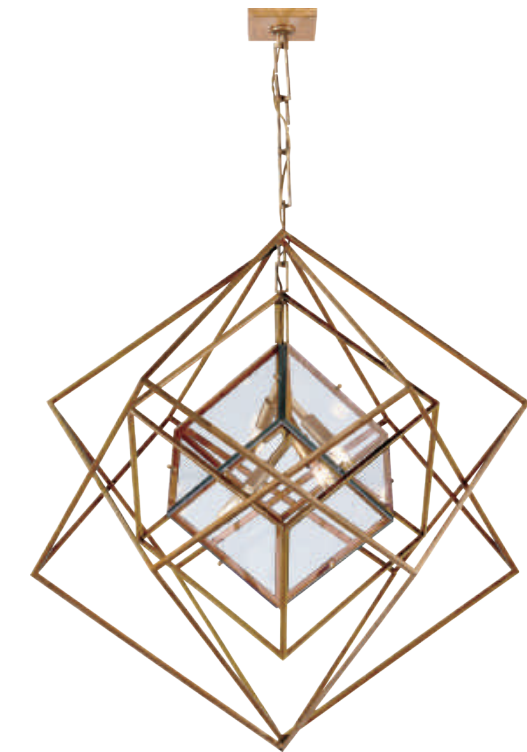
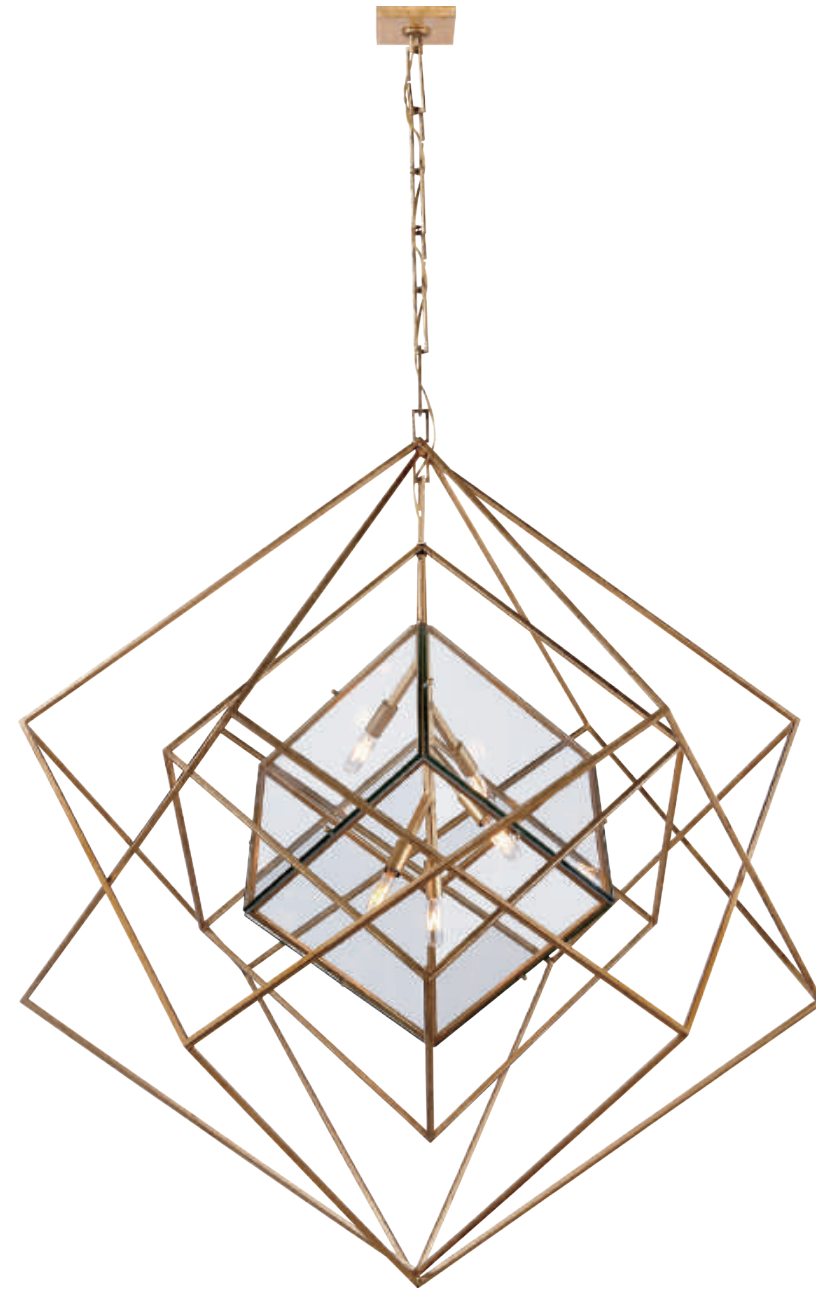

**B** | **KW5021G-CG**  
Gild | Clear Glass

**B** | **KW5021AI-CG**  
Aged Iron | Clear Glass

**C** | **KW5022G-CG**  
Gild | Clear Glass



**B** | **KW5021AI-CG**  
Aged Iron | Clear Glass

**A** | **CUBIST SMALL CHANDELIER**  
KELLY WEARSTLER

**KW5020**  
Fixture: 25.5" H | W: 22" | Canopy: 4.5" Square  
Socket: E26 Keyless | Bulb: 60 A

**B** | **CUBIST MEDIUM CHANDELIER**  
KELLY WEARSTLER

**KW5021**  
Fixture: 36" H | W: 31.25" | Canopy: 4.5" Square  
Socket: 4 - E12 Candelabra | Bulb: 4 - 60 B

**C** | **CUBIST LARGE CHANDELIER**  
KELLY WEARSTLER

**KW5022**  
Fixture: 51.25" H | W: 45.25" | Canopy: 6" Square  
Socket: 5 - E12 Candelabra | Bulb: 5 - 60 B  
**Additional Options:**  
Aged Iron | Clear Glass (AI-CG)



B CHC3112AI  
Aged Iron



A LAWRENCE SMALL SPUTNIK CHANDELIER  
E. F. CHAPMAN

CHC3111  
H: 20" | W: 20" | Canopy: 5.5" Round  
Socket: 20 - E12 Candelabra | Bulb: 20 - 40 B  
©EFC DESIGNS



A CHC3111PN  
Polished Nickel



A CHC3111G  
Gild



A CHC3111AI  
Aged Iron

B LAWRENCE MEDIUM SPUTNIK CHANDELIER  
E. F. CHAPMAN

CHC3112  
H: 30" | W: 30" | Canopy: 5.5" Round  
Socket: 20 - E12 Candelabra | Bulb: 20 - 40 B  
©EFC DESIGNS



B CHC3112PN  
Polished Nickel



B CHC3112G  
Gild



B CHC3112AI  
Aged Iron



**A STRADA MEDIUM ROUND CHANDELIER**  
KELLY WEARSTLER

**KW5071**  
Fixture: 28.25" H | W: 28" | Canopy: 4.75" Round  
Socket: 20 - E12 Candelabra | Bulb: 20 - 40 C

**B STRADA LARGE ROUND CHANDELIER**  
KELLY WEARSTLER

**KW5072**  
H: 40.75" | W: 40.25" | Canopy: 4.75" Round  
Socket: 20 - E12 Candelabra | Bulb: 20 - 40 C  
**Additional Options:**  
Burnished Silver Leaf (BSL)

A KW5071G  
Gild



A KW5071PN  
Polished Nickel

A KW5071G  
Gild

A KW5071BSL  
Burnished Silver Leaf

A KW5071AI  
Aged Iron



B KW5072PN  
Polished Nickel

B KW5072G  
Gild

B KW5072AI  
Aged Iron



**A** | **KW5074PN**  
Polished Nickel



**A** | **KW5074G**  
Gild



**B** | **KW5075BSL**  
Burnished Silver Leaf



**B** | **KW5075AI**  
Aged Iron

**A** | **STRADA MEDIUM OVAL CHANDELIER**  
KELLY WEARSTLER

**KW5074**  
Fixture: 26.5" H | W: 38" | Canopy: 4.75" Round  
Socket: 20 - E12 Candelabra | Bulb: 20 - 40 C  
**Additional Options:**  
Aged Iron (AI)  
Burnished Silver Leaf (BSL)

**B** | **STRADA LARGE OVAL CHANDELIER**  
KELLY WEARSTLER

**KW5075**  
H: 36" | W: 50" | Canopy: 4.75" Round  
Socket: 20 - E12 Candelabra | Bulb: 20 - 40 C  
**Additional Options:**  
Gild (G)  
Polished Nickel (PN)

opposite page

**C** | **STRADA RING CHANDELIER**  
KELLY WEARSTLER

**KW5181**  
H: 25.75" | W: 40" | Canopy: 5.5" Round  
Socket: 16 - E12 Candelabra | Bulb: 16 - 40 C  
**Additional Options:**  
Burnished Silver Leaf (BSL)  
Gild (G)  
Polished Nickel (PN)

**D** | **STRADA SMALL CHANDELIER**  
KELLY WEARSTLER

**KW5077**  
Fixture: 23.75" H | W: 9.25" | Canopy: 4.75" Round  
Socket: E26 Keyless | Bulb: 60 A  
**Additional Options:**  
Burnished Silver Leaf (BSL)  
Aged Iron (AI)



**C** | **KW5181AI**  
Aged Iron



**D** | **KW5077PN**  
Polished Nickel



**D** | **KW5077G**  
Gild





**A** | **JN5063WHT**  
Matte White



**A** | **JN5063GI**  
Gilded Iron

**A** | **LUNA MEDIUM CHANDELIER**  
JULIE NEILL

**JN5063**  
H: 55.75" | Fixture: 22" H | W: 20"  
Canopy: 5" Round  
Socket: 16 - E12 Candelabra | Bulb: 16 - 25 B  
\* Custom Height Available (26" Minimum)

**B** | **LUNA LARGE CHANDELIER**  
JULIE NEILL

**JN5064**  
H: 65" | Fixture: 31.5" H | W: 30"  
Canopy: 5" Round  
Socket: 16 - E12 Candelabra | Bulb: 16 - 40 B



**B** | **JN5064WHT**  
Matte White



**B** | **JN5064GI**  
Gilded Iron

opposite page

**C** | **DUMAINE MEDIUM PIERCED LEAF CHANDELIER**  
JULIE NEILL

**JN5517**  
H: 33.5" | W: 41.75" | Canopy: 6" Round  
Socket: 6 - E12 Candelabra | Bulb: 6 - 60 C

**D** | **MANDEVILLE LINEAR CHANDELIER**  
JULIE NEILL

**JN5070**  
H: 29" | W: 42" | Ext: 24"  
Canopy: 4.75" Round  
Socket: 6 - E12 Candelabra | Bulb: 6 - 40 G



**C** | **JN5517PN**  
Polished Nickel



**C** | **JN5517AB**  
Antique-Burnished Brass



**D** | **JN5070PW**  
Plaster White



**D** | **JN5070AGL**  
Antique Gold Leaf





**A** | **CHC5163WHT/G**  
White | Gild

**A** | **CHC5163BSL**  
Burnished Silver Leaf

**B** | **CHC5165G**  
Gild

**B** | **CHC5165MBK/G**  
Matte Black | Gild



**C** | **CHC5157WHT/G**  
White | Gild

**C** | **CHC5157BSL**  
Burnished Silver Leaf

**D** | **CHC5158G**  
Gild

**D** | **CHC5158MBK/G**  
Matte Black | Gild

**A** | **CYNARA SMALL CHANDELIER**  
E. F. CHAPMAN  
  
**CHC5163**  
H: 15.25" | W: 16.75" | Canopy: 5.5" Round  
Socket: E26 Keyless | Bulb: 100 A  
©EFC DESIGNS

**B** | **CYNARA MEDIUM CHANDELIER**  
E. F. CHAPMAN  
  
**CHC5165**  
Fixture: 21" H | W: 22.5" | Canopy: 6.75" Round  
Socket: E26 Keyless | Bulb: 100 A  
©EFC DESIGNS

**C** | **CYNARA LARGE CHANDELIER**  
E. F. CHAPMAN  
  
**CHC5157**  
Fixture: 27" H | W: 29" | Canopy: 8.75" Round  
Socket: E26 Keyless | Bulb: 100 A  
©EFC DESIGNS

**D** | **CYNARA GRANDE CHANDELIER**  
E. F. CHAPMAN  
  
**CHC5158**  
H: 33.25" | W: 36" | Canopy: 8.75" Round  
Socket: 6 - E12 Candelabra | Bulb: 6 - 40 C  
©EFC DESIGNS

**Available Options for Cynara:**  
Burnished Silver Leaf (BSL)  
Gild (G)  
Matte Black | Gild (MBK/G)  
White | Gild (WHT/G)



**C** | **CHC5157WHT/G**  
White | Gild



**B** | **CHC5165WHT/G**  
White | Gild





**A HATTON SMALL CHANDELIER**  
BARRY GORALNICK

**S5047**  
H: 16" | W: 14.75" | Canopy: 6" Round  
Socket: 4 - E12 Candelabra | Bulb: 4 - 60 C

**B HATTON LARGE CHANDELIER**  
BARRY GORALNICK

**S5048**  
H: 37" | W: 31.25" | Canopy: 6" Round  
Socket: 4 - E12 Candelabra | Bulb: 4 - 60 C

**B S5048BSL**  
Burnished Silver Leaf



**A S5047AI**  
Aged Iron

**A S5047G**  
Gild

**A S5047BSL**  
Burnished Silver Leaf



**B S5048AI**  
Aged Iron

**B S5048G**  
Gild

**B S5048BSL**  
Burnished Silver Leaf



**A** | **ARN5001PW**  
Plaster White



**A** | **ARN5001BSL**  
Burnished Silver Leaf



**A** | **ARN5001G**  
Gild



**B** | **ARN5011PW**  
Plaster White



**B** | **ARN5011BSL**  
Burnished Silver Leaf



**B** | **ARN5011G**  
Gild

**A** | **HAMPTON MEDIUM CHANDELIER**  
AERIN  
**ARN5001**  
H: 9.25" | W: 21.5" | Canopy: 6" Round  
Socket: 3 - E12 Candelabra | Bulb: 3 - 60 C

**B** | **HAMPTON LARGE CHANDELIER**  
AERIN  
**ARN5011**  
Fixture: 10.5" H | W: 25.5" | Canopy: 6" Round  
Socket: 6 - E12 Candelabra | Bulb: 6 - 60 C

opposite page

**C** | **BENIT MEDIUM CHANDELIER**  
AERIN  
**ARN5426**  
H: 29.75" | W: 32" | Canopy: 6.25" Round  
Socket: 4 - E12 Candelabra | Bulb: 4 - 40 B  
**Additional Options:**  
Burnished Silver Leaf (BSL)  
Gild | Gilded Plaster (GP)



**C** | **ARN5426PW**  
Plaster White



**A ROSEHILL LARGE CHANDELIER**  
AERIN  
**ARN5111**  
H: 30.25" | W: 21" | Canopy: 5.75" Round  
Socket: 4 - E12 Candelabra  
Bulb: 4 - 60 C

**B MEZAN MEDIUM CHANDELIER**  
AERIN  
**ARN5330**  
H: 31.5" | W: 22.25" | Canopy: 6" Round  
Socket: 4 - E12 Candelabra  
Bulb: 4 - 40 C



**C KW5618PN-ALB**  
Polished Nickel | Alabaster

**D CHARLES SMALL CHANDELIER**  
ALEXA HAMPTON  
**AH5000**  
H: 21.5" | W: 14" | Canopy: 5" Round  
Socket: 3 - E12 Candelabra | Bulb: 3 - 40 C

**E CHARLES LARGE CHANDELIER**  
ALEXA HAMPTON  
**AH5002**  
H: 23" | W: 28" | Canopy: 5.25" Round  
Socket: 3 - E26 Keyless | Bulb: 3 - 60 B  
\* Custom Height Available



**D AH5000ALB**  
Alabaster | Bronze



**E AH5002ALB**  
Alabaster | Bronze



**C MELANGE SMALL PENDANT**  
KELLY WEARSTLER  
**KW5618**  
H: 63.75" | Fixture: 30" H | W: 15"  
Canopy: 4.75" Round  
Socket: 3 - E12 Candelabra  
Bulb: 3 - 4.5 LED B  
**Additional Options:**  
Bronze | Alabaster (BZ-ALB)



**C KW5618AB-ALB**  
Antique-Burnished Brass | Alabaster

**F O'CONNOR CHANDELIER**  
AERIN  
**ARN5202**  
H: 30.75" | W: 16" | Canopy: 5.5" Round  
Socket: 3 - E12 Candelabra | Bulb: 3 - 60 C

**G FLUTED BAND MEDIUM CHANDELIER**  
E. F. CHAPMAN  
**CHC2149**  
H: 30.5" | W: 18.25" | Canopy: 6.25" Round  
Socket: 2 - E26 Keyless | Bulb: 2 - 60 A  
\* Custom Height Available (20" Minimum)  
©EFC DESIGNS



**F ARN5202HAB/ALB**  
Hand-Rubbed Antique Brass | Alabaster



**G CHC2149ALB**  
Alabaster | Brass



CEILING | LINEAR



A | KW5550G-FA  
Gild | Frosted Acrylic

A | **UTOPIA LARGE LINEAR PENDANT**  
KELLY WEARSTLER

**KW5550**  
H: 30.5" | Fixture: 7.5" H | W: 60.25"  
Canopy: 4" x 36" Rec.  
Socket: 6 - E26 Keyless | Bulb: 6 - 14.5 LED A  
\* Custom Height Available (18" Minimum)



A | KW5550G-FA  
Gild | Frosted Acrylic

A | KW5550AI-FA  
Aged Iron | Frosted Acrylic

B | **STRADA LARGE LINEAR CHANDELIER**  
KELLY WEARSTLER

**KW5182**  
H: 22" | W: 60" x 12" | Canopy: 4.5" Round  
Socket: 16 - E12 Candelabra | Bulb: 16 - 25 B  
**Additional Options:**  
Burnished Silver Leaf (BSL)  
Polished Nickel (PN)  
\* Requires Special Assembly and Installation



B | KW5182G  
Gild

B | KW5182AI  
Aged Iron



**A** | **PB5200PN**  
Polished Nickel

**A** | **PB5200MBK**  
Matte Black



**B** | **KW5523PN-FG**  
Polished Nickel | Frosted Glass

**B** | **KW5523BZ-FG**  
Bronze | Frosted Glass



**B** | **KW5523AB-FG**  
Antique-Burnished Brass | Frosted Glass

**A** | **DOT LARGE TRIPLE PENDANT**  
PETER BRISTOL

**PB5200**  
H: 42.5" | Fixture: 8" H | W: 60"  
Ext: 30.5" | Canopy: 6" Round  
LED: 45w  
**Additional Options:**  
Natural Brass (NB)  
\* Custom Height Available (14" Minimum)

**B** | **AVANT LARGE LINEAR PENDANT**  
KELLY WEARSTLER

**KW5523**  
H: 37.75" | Fixture: 4" H | W: 60"  
Canopy: 6" x 36" Rec.  
Socket: 5 - E17 Keyless | Bulb: 5 - 40 T  
\* Custom Height Available (7" Minimum)



**A** | **KW5591PN-SG**  
Polished Nickel | Seeded Glass

**A** | **KW5591AB-SG**  
Antique-Burnished Brass | Seeded Glass

**A** | **KW5591BZ-EC**  
Bronze | Etched Crystal



**B** | **KW5317PN-L**  
Polished Nickel | Linen

**B** | **KW5317AB-L**  
Antique-Burnished Brass | Linen

**B** | **KW5317BZ-L**  
Bronze | Linen

opposite page

**A** | **ROUSSEAU MEDIUM LINEAR CHANDELIER**  
KELLY WEARSTLER

**KW5591**  
H: 63.75" | Fixture: 26.5" H | W: 29.25"  
Canopy: 4.5" Round | LED: 8w  
**Additional Options:**  
Antique-Burnished Brass | Etched Crystal (BZ-EC)  
Polished Nickel | Etched Crystal (PN-EC)  
Bronze | Seeded Glass (BZ-SG)

**B** | **FORZA MEDIUM GATHERED LINEAR LANTERN**  
KELLY WEARSTLER

**KW5317**  
H: 48.5" | Fixture: 33.75" H | W: 40"  
Canopy: 6" x 28" Oval  
Socket: 6 - E26 Keyless | Bulb: 6 - 40 T  
Shade: 40" x 15" x 16" Rec.

**C** | **LR5910HAB-CG**  
Hand-Rubbed Antique Brass | Crystal



**C** | **FASCIO MEDIUM LINEAR CHANDELIER**  
LAUREN ROTTET

**LR5910**  
H: 41.75" | Fixture: 4" H | W: 38"  
Canopy: 4.5" x 10" Decorative | LED: 25w  
**Additional Options:**  
Bronze | Crystal (BZ-CG)  
Polished Nickel | Crystal (PN-CG)





**A** | **ARN5312PN-CG**  
Polished Nickel | Clear Glass

**A** | **ARN5312HAB-CG**  
Hand-Rubbed Antique Brass | Clear Glass

**A** | **ALPINE MEDIUM LINEAR CHANDELIER**  
AERIN  
  
**ARN5312**  
H: 44.25" | Fixture: 16.25" H | W: 45.25"  
Canopy: 4.5" x 16" Rec.  
Socket: 16 - E12 Candelabra | Bulb: 16 - 60 C  
**Additional Options:**  
Hand-Rubbed Antique Brass | White Glass (HAB-WG)  
Polished Nickel | White Glass (PN-WG)

**B** | **BONNINGTON LARGE LINEAR CHANDELIER**  
AERIN  
  
**ARN5127**  
H: 15.25" | W: 55" x 24.5" | Canopy: 6" x 38" Oval  
Socket: 24 - E12 Candelabra | Bulb: 24 - 25 B  
\* Requires Special Assembly and Installation



**C** | **SK5055PN-NP**  
Polished Nickel | Natural Paper



**C** | **SK5055HAB-NP**  
Hand-Rubbed Antique Brass | Natural Paper



**B** | **ARN5127PN-CG**  
Polished Nickel | Crystal

**B** | **ARN5127HAB-CG**  
Hand-Rubbed Antique Brass | Crystal

opposite page

**C** | **CAMILLE MEDIUM LINEAR CHANDELIER**  
SUZANNE KASLER  
  
**SK5055**  
H: 26" | W: 53.25" | Canopy: 5" x 16" Rec.  
Socket: 5 - E12 Candelabra | Bulb: 5 - 40 B  
Shade: 4" x 5.5" x 6"  
**Additional Options:**  
Bronze | Natural Paper (BZ-NP)

**D** | **LIAISON LARGE LINEAR CHANDELIER**  
KELLY WEARSTLER

**KW5203**  
H: 22.5" | W: 62" | Canopy: 4.5" x 29.75" Rec.  
Socket: 6 - E12 Candelabra | Bulb: 6 - 60 C  
**Additional Options:**  
Bronze | Crackle Glass (BZ-CRG)



**D** | **KW5203PN-CRG**  
Polished Nickel | Crackle Glass



**D** | **KW5203AB-CRG**  
Antique-Burnished Brass | Crackle Glass



**A** | **S5177PN-CG**  
Polished Nickel | Clear Glass



**A** | **S5177HAB-CG**  
Hand-Rubbed Antique Brass | Clear Glass

opposite page

**A** | **PRESIDIO LARGE LINEAR LANTERN**  
IAN K. FOWLER

**S5177**  
O/A H: 61" | Fixture: 15.5" H | W: 54"  
Canopy: 4.75" x 50" Rec.  
Socket: 5 - E26 Keyless | Bulb: 5 - 60 T  
\* Custom Height Available (24" Minimum)

**B** | **PALOMAR LARGE ROTATING LINEAR CHANDELIER**  
IAN K. FOWLER

**S5140**  
H: 44.25" | Fixture: 24" H | W: 60"  
Canopy: 4.75" x 38.5" Rec.  
Socket: 24 - G9 Keyless | Bulb: 24 - 2w LED  
\* Bulbs Included



**C** | **TOB5705PN-CG**  
Polished Nickel | Clear Glass

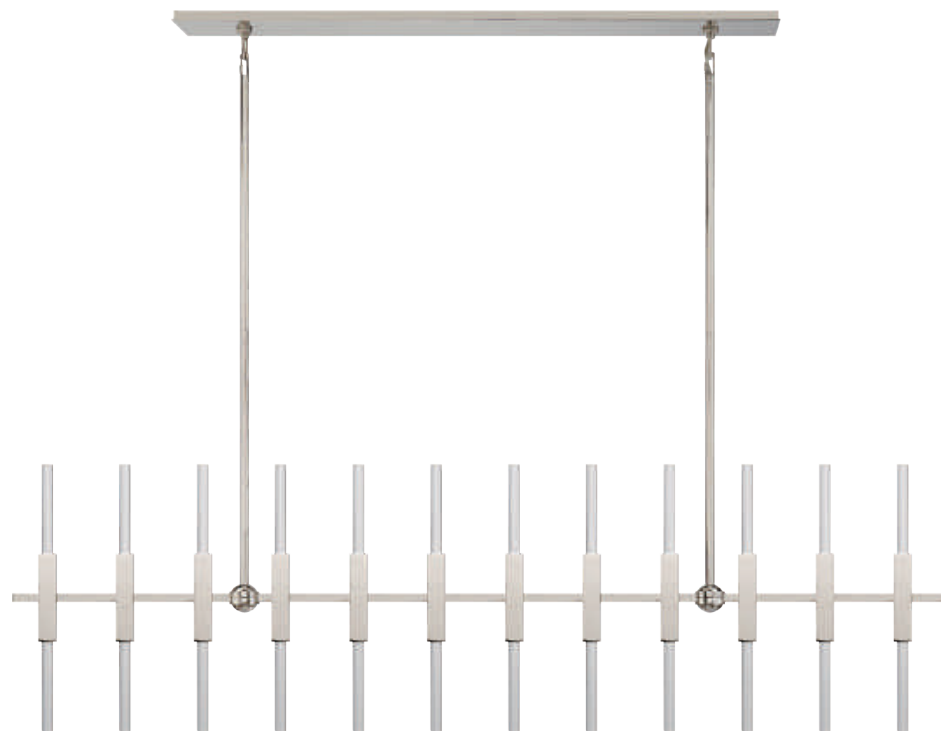

**B** | **S5140PN-CA**  
Polished Nickel | Clear Acrylic

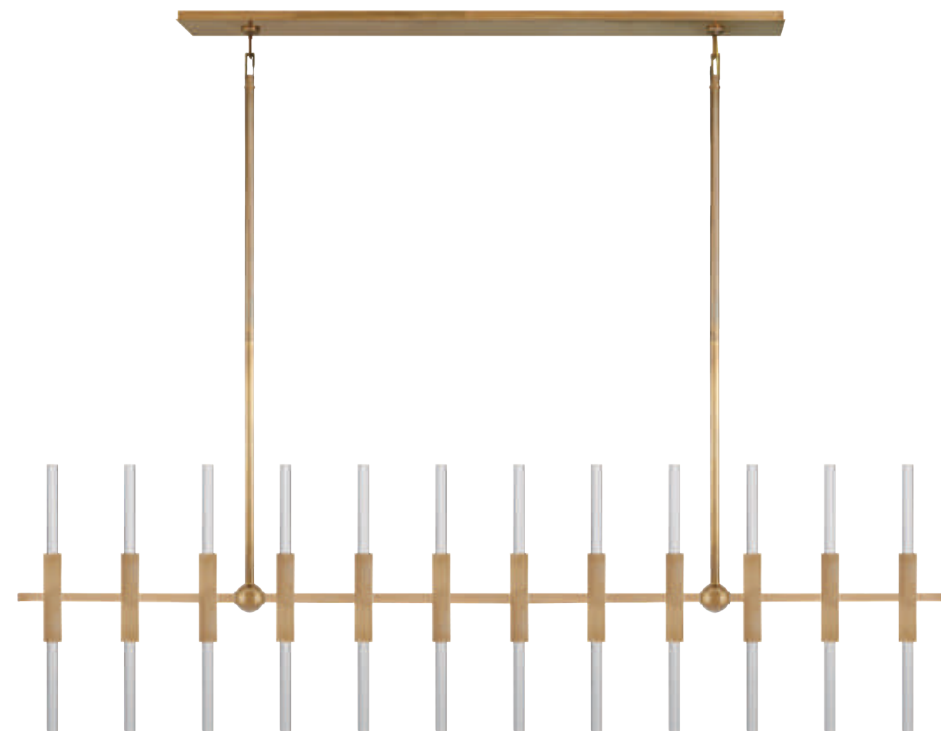

**B** | **S5140HAB-CA**  
Hand-Rubbed Antique Brass | Clear Acrylic

**C** | **IRIS QUATRO LINEAR PENDANT**  
THOMAS O'BRIEN

**TOB5705**  
Fixture: 9.5" H | W: 36.75" | Canopy: 6" x 34.5" Rec.  
Socket: 4 - E26 Keyless | Bulb: 4 - 60 G  
**Additional Options:**  
Hand-Rubbed Antique Brass | Clear Glass (HAB-CG)  
\* Custom Height Available (15" Minimum)



**C** | **TOB5705BZ/HAB-CG**  
Bronze | Brass | Clear Glass



A | **S5015PN**  
Polished Nickel | Clear Glass

**A BELDEN LINEAR LANTERN**  
IAN K. FOWLER

**S5015**  
H: 53" | Fixture: 14" H | W: 56"  
Canopy: 4.5" x 44" Rec.  
Socket: 6 - E26 Keyless | Bulb: 6 - 60 T  
**Additional Options:**  
Aged Iron | Clear Glass (AI)  
\* Custom Height Available (26" Minimum)



B | **S5195PN-CG**  
Polished Nickel | Clear Glass

B | **S5195AI-CG**  
Aged Iron | Clear Glass



C | **S5327PN-L**  
Polished Nickel | Linen

C | **S5327AI-L**  
Aged Iron | Linen

opposite page

**B HALLE LARGE LINEAR PENDANT**  
IAN K. FOWLER

**S5195**  
H: 55.5" | Fixture: 19.5" H | W: 56"  
Ext: 9.5" | Canopy: 4" x 44" Rec.  
Socket: 6 - E26 Keyless | Bulb: 6 - 40 T  
\* Custom Height Available (30" Minimum)

**C MILO LARGE LINEAR PENDANT**  
IAN K. FOWLER

**S5327**  
H: 47.5" | Fixture: 10.5" H | W: 43" x 9.5"  
Canopy: 4.25" x 37.75" Rec.  
Socket: 7 - E12 Candelabra | Bulb: 7 - 40 B  
\* Requires Special Assembly and Installation  
\* Custom Height Available (17" Minimum)



**A** | **CHC2168AI**  
Aged Iron



**A** | **CHC2168GI**  
Gilded Iron



**A** | **CHC2168PN**  
Polished Nickel



**B** | **CHC2156GI**  
Gilded Iron



**B** | **CHC2156PN**  
Polished Nickel

**C** | **CHC2166AI**  
Aged Iron



**A** | **DARLANA SMALL LINEAR LANTERN**  
E. F. CHAPMAN

**CHC2168**  
H: 19" | W: 30" | Ext: 13"  
Canopy: 4.5" x 16" Rec.  
Socket: 4 - E12 Candelabra | Bulb: 4 - 60 C  
©EFC DESIGNS

**B** | **DARLANA MEDIUM LINEAR LANTERN**  
E. F. CHAPMAN

**CHC2156**  
Fixture: 20.25" H | W: 41" | Canopy: 4.5" x 20" Rec.  
Socket: 5 - E12 Candelabra | Bulb: 5 - 60 C  
**Additional Options:**  
Aged Iron (AI)  
©EFC DESIGNS

**C** | **DARLANA LARGE LINEAR LANTERN**  
E. F. CHAPMAN

**CHC2166**  
H: 25.75" | W: 54" | Ext: 17"  
Canopy: 6" x 26.5" Rec.  
Socket: 6 - E12 Candelabra | Bulb: 6 - 60 C  
**Additional Options:**  
Antique-Burnished Brass (AB)  
©EFC DESIGNS



A PLANTATION LARGE LINEAR PENDANT  
E. F. CHAPMAN

**CHC5438**  
 Fixture: 29" H | W: 54"  
 Canopy: 6" x 28.5" Rec.  
 Socket: 7 - E12 Candelabra | Bulb: 7 - 60 C  
 ©EFC DESIGNS

A CHC5438AB-CG  
 Antique-Burnished Brass | Clear Glass



A CHC5438PN-CG  
 Polished Nickel | Clear Glass

A CHC5438AB-CG  
 Antique-Burnished Brass | Clear Glass

A CHC5438AN-CG  
 Antique Nickel | Clear Glass

A CHC5438BZ-CG  
 Bronze | Clear Glass



**A** CHC2183GI  
Gilded Iron

**A** DARLANA LARGE FANCY LINEAR LANTERN  
E. F. CHAPMAN  
  
CHC2183  
Fixture: 28" H | W: 51.75" | Canopy: 6" x 28.5" Rec.  
Socket: 8 - E12 Candelabra | Bulb: 8 - 40 C  
©EFC DESIGNS



**A** CHC2183AI  
Aged Iron

opposite page  
**B** CADDO MEDIUM LINEAR LANTERN  
JULIE NEILL  
  
JN5023  
H: 28.25" | W: 44.75" x 19" | Canopy: 5.5" x 24" Rec.  
Socket: 10 - E12 Candelabra | Bulb: 10 - 60 C

**C** CADDO LARGE LINEAR LANTERN  
JULIE NEILL  
  
JN5025  
H: 31" | W: 56" x 17" | Ext: 17"  
Canopy: 5.5" x 34.5" Rec.  
Socket: 7 - E12 Candelabra | Bulb: 7 - 60 C  
**Additional Options:**  
Celadon | Gild | Clear Glass (CEL/G-CG)  
\* Requires Special Assembly and Installation



**B** JN5023SW/G-CG  
Soft White | Gild | Clear Glass

**B** JN5023CEL/G-CG  
Celadon | Gild | Clear Glass

**B** JN5023MBK/G-CG  
Matte Black | Gild | Clear Glass

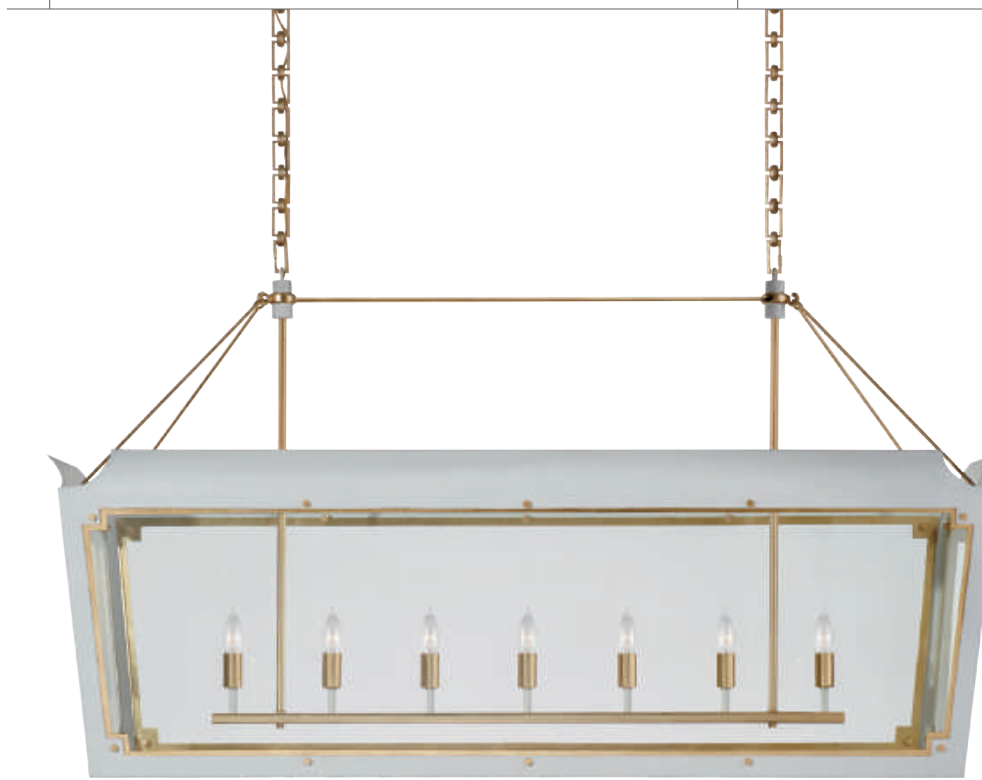

**C** JN5025SW/G-CG  
Soft White | Gild | Clear Glass

**C** JN5025MBK/G-CG  
Matte Black | Gild | Clear Glass



**A** **CHC5495GI**  
Gilded Iron



**A** **CHC5495AI**  
Aged Iron



**B** **CHC5495GI-L**  
Gilded Iron | Linen



**B** **CHC5495AI-L**  
Aged Iron | Linen

opposite page

**A** **FLEMISH LARGE LINEAR PENDANT**  
E. F. CHAPMAN

**CHC5495**  
Fixture: 28" H | W: 50" | Canopy: 6" x 19" Rec.  
Socket: 11 - E12 Candelabra | Bulb: 40 C  
©EFC DESIGNS

**B** **FLEMISH LARGE LINEAR PENDANT**  
E. F. CHAPMAN

**CHC5495**  
Fixture: 28" H | W: 50" | Canopy: 6" x 19" Rec.  
Socket: 11 - E12 Candelabra | Bulb: 40 C  
Shade: 11 - 4" x 5.5" x 4.5"  
©EFC DESIGNS



**C** **SL5863PN**  
Polished Nickel



**C** **SL5863HAB**  
Hand-Rubbed Antique Brass

**C** **LINEAR BRANCHED CHANDELIER**  
E. F. CHAPMAN

**SL5863**  
H: 52" | W: 35" | Canopy: 5.25" Round  
Socket: 10 - E12 Candelabra | Bulb: 10 - 60 C  
**Additional Options:**  
Antique Nickel (AN)  
Bronze (BZ)  
\* CHS104NP Shades Sold Separately  
\* Use 40 Bulb Frosted Type "B" with Clip On Shade  
\* Custom Height Available (24" Minimum)  
©EFC DESIGNS

**D** **LINEAR BRANCHED CHANDELIER**  
E. F. CHAPMAN

**SL5863**  
H: 52" | W: 36" | Canopy: 5.25" Round  
Socket: 10 - E12 Candelabra | Bulb: 10 - 60 C |  
Shade: 2 - 36.5" x 37" x 6.5" Rec.  
**Additional Options:**  
Hand-Rubbed Antique Brass | Natural Paper (HAB-NP2)  
Polished Nickel | Natural Paper Rectangle (PN-NP2)  
\* Custom Height Available (32" Minimum)  
©EFC DESIGNS



**D** **SL5863AN-NP2**  
Antique Nickel | Natural Paper Rectangle



**D** **SL5863BZ-NP2**  
Bronze | Natural Paper Rectangle



A **CHC1605PN**  
Polished Nickel



A **CHC1605AB**  
Antique-Burnished Brass



A **CHC1605AN**  
Antique Nickel



A **CHC1605BZ**  
Bronze

opposite page

A **LAUNCETON LARGE LINEAR PENDANT**  
E. F. CHAPMAN

**CHC1605**  
Fixture: 30" H | W: 52" | Ext: 4.25"  
Canopy: 5.25" Round  
Socket: 5 - E12 Candelabra | Bulb: 5 - 60 C  
©EFC DESIGNS



B **SL5811PN-NP**  
Polished Nickel | Natural Paper



B **SL5811HAB-NP**  
Hand-Rubbed Antique Brass | Natural Paper



B **SL5811AN-NP**  
Antique Nickel | Natural Paper



B **SL5811BZ-NP**  
Bronze | Natural Paper

B **CLASSIC LINEAR CHANDELIER**  
E. F. CHAPMAN

**SL5811**  
H: 37.5" | W: 45.25" | Canopy: 5.5" Round  
Socket: 5 - E12 Candelabra | Bulb: 5 - 40 B  
Shade: 3" x 6.5" x 5"  
©EFC DESIGNS



**A FONTAINE LINEAR CHANDELIER**  
AERIN

**ARN5201**  
H: 39" | W: 45.25" | Canopy: 6" Round  
Socket: 6 - E12 Candelabra | Bulb: 6 - 40 B  
Shade: 3" x 5.5" x 9.5"

**B ETOILE LINEAR CHANDELIER**  
IAN K. FOWLER

**S5316**  
H: 64" | Fixture: 23.5" H | W: 48"  
Canopy: 5.5" Round  
Socket: 4 - E12 Candelabra | Bulb: 4 - 60 B  
Shade: 4.5" x 5.5" x 6.5"



**A ARN5201PL-L**  
Plaster | Linen



**A ARN5201GP-L**  
Gilded Plaster | Linen



**A ARN5201AI-L**  
Aged Iron | Linen



**B S5316GI-NP**  
Gilded Iron | Natural Paper



**B S5316BR-NP**  
Blackened Rust | Natural Paper



**A** | **CHC1481PN-L**  
Polished Nickel | Linen



**A** | **CHC1481BZ-L**  
Bronze | Linen



**B** | **CHC1482AB-L**  
Antique-Burnished Brass | Linen



**C** | **CHC5102AB-AB**  
Antique-Burnished Brass | Brass

opposite page

**A** | **GROSVENOR LINEAR DOUBLE PENDANT**  
E. F. CHAPMAN

**CHC1481**  
H: 42.5" | W: 51" | Canopy: 6" Round  
Socket: 4 - E26 Keyless | Bulb: 4 - 75 A  
Shade: 12" x 15" x 10.5"  
**Additional Options:**  
Antique-Burnished Brass | Linen (AB-L)  
Antique Nickel | Linen (AN-L)  
\* Custom Height Available (28" Minimum)  
©EFC DESIGNS

**B** | **GROSVENOR LINEAR TRIPLE PENDANT**  
E. F. CHAPMAN

**CHC1482**  
H: 42.5" | W: 74.5" | Canopy: 6" Round  
Socket: 6 - E26 Keyless | Bulb: 6 - 75 A  
Shade: 12" x 15" x 10.5"  
**Additional Options:**  
Antique Nickel | Linen (AN-L)  
Bronze | Linen (BZ-L)  
Polished Nickel | Linen (PN-L)  
\* Custom Height Available (28" Minimum)  
©EFC DESIGNS

**C** | **SLOANE DOUBLE SHOP PENDANT**  
E. F. CHAPMAN

**CHC5102**  
H: 57" | W: 54" | Canopy: 5.75" Round  
Socket: 4 - E26 Keyless | Bulb: 4 - 60 A  
Shade: 11.5" x 15.5" x 10"  
**Additional Options:**  
Antique-Burnished Brass | Linen (AB-L)  
Antique Nickel | Antique Nickel (AN-AN)  
Antique Nickel | Linen (AN-L)  
Bronze | Bronze (BZ-BZ)  
Bronze | Linen (BZ-L)  
\* Custom Height Available (39" Minimum)  
©EFC DESIGNS



**A CLASSIC BILLIARD LIGHT**  
E. F. CHAPMAN

**SL5816**  
H: 32" | W: 42" | Canopy: 5.5" Round  
Socket: 6 - E12 Candelabra | Bulb: 6 - 60 C  
Shade: 12.5" x 14" x 8"  
©EFC DESIGNS

**A SL5816PN-NP**  
Polished Nickel | Natural Paper



**A SL5816PN-NP**  
Polished Nickel | Natural Paper

**A SL5816AN-NP**  
Antique Nickel | Natural Paper

**A SL5816HAB-NP**  
Hand-Rubbed Antique Brass | Natural Paper

**A SL5816BZ-NP**  
Bronze | Natural Paper



**A** | **TOB5004BZ-NP**  
Bronze | Natural Paper

**A** | **BRYANT SMALL BILLIARD**  
THOMAS O'BRIEN

**TOB5004**  
H: 32" | W: 36" | Canopy: 3" x 36" Rec.  
Socket: 3 - E26 Keyless | Bulb: 3 - 75 A  
Shade: 6.5" x 8" x 7.5"  
\* Custom Height Available (20" Minimum)

**B** | **BRYANT LARGE BILLIARD**  
THOMAS O'BRIEN

**TOB5005**  
H: 32" | W: 60" | Canopy: 3" x 60" Rec.  
Socket: 3 - E26 Keyless | Bulb: 3 - 75 A  
Shade: 10.5" x 12" x 7.5"  
**Additional Options:**  
Antique Nickel | Natural Paper (AN-NP)  
Bronze | Natural Paper (BZ-NP)  
\* Custom Height Available (20" Minimum)



**A** | **TOB5004HAB-NP**  
Hand-Rubbed Antique Brass | Natural Paper

**A** | **TOB5004AN-NP**  
Antique Nickel | Natural Paper

**A** | **TOB5004PN-NP**  
Polished Nickel | Natural Paper



**B** | **TOB5005HAB-NP**  
Hand-Rubbed Antique Brass | Natural Paper

**B** | **TOB5005PN-NP**  
Polished Nickel | Natural Paper



CEILING | HANGING SHADES



**A** | **BBL5088WHT**  
Matte White



**A** | **BBL5088BSL**  
Burnished Silver Leaf



**B** | **BBL5090G**  
Gild



opposite page

**A** | **HALO TALL HANGING SHADE**  
BARBARA BARRY

**BBL5088**  
H: 31.5" - 130" | Fixture: 17" H | W: 9.5"  
Canopy: 5" Round  
Socket: E26 Keyless | Bulb: 100 A  
**Additional Options:**  
Matte Black (BLK)  
Gild (G)



**B** | **BBL5090WHT**  
Matte White



**B** | **BBL5090BLK**  
Matte Black



**C** | **BBL5089BSL**  
Burnished Silver Leaf



**C** | **BBL5089G**  
Gild

**B** | **HALO MEDIUM HANGING SHADE**  
BARBARA BARRY

**BBL5090**  
H: 25" - 186" | Fixture: 10.5" H | W: 27.5"  
Canopy: 4.5" Round  
Socket: 3 - E26 Keyless | Bulb: 3 - 60 A  
**Additional Options:**  
Burnished Silver Leaf (BSL)

**C** | **HALO SMALL HANGING SHADE**  
BARBARA BARRY

**BBL5089**  
H: 25" - 119" | Fixture: 10.5" H | W: 19"  
Canopy: 5" Round  
Socket: 2 - E26 Keyless | Bulb: 2 - 60 A  
**Additional Options:**  
Matte Black (BLK)  
Matte White (WHT)



A | **ARN5305BSL**  
Burnished Silver Leaf



A | **ARN5305G**  
Gild



B | **ARN5306G**  
Gild

A | **ARABELLE TALL HANGING SHADE**  
AERIN  
**ARN5305**  
H: 26.75" | W: 17" | Canopy: 6" Flower  
Socket: 6 - E12 Candelabra | Bulb: 6 - 40 B

B | **ARABELLE HANGING SHADE**  
AERIN  
**ARN5306**  
Fixture: 18.25" H | W: 28" | Canopy: 5.75" Flower  
Socket: 5 - E26 Keyless | Bulb: 5 - 60 A

C | **ARABELLE LARGE OVAL HANGING SHADE**  
AERIN  
**ARN5307**  
H: 13" | W: 34.75" | Canopy: 5.75" x 19" Oval  
Socket: 6 - E26 Keyless | Bulb: 6 - 40 A



B | **ARN5306BSL**  
Burnished Silver Leaf



B | **ARN5306G**  
Gild



C | **ARN5307BSL**  
Burnished Silver Leaf



C | **ARN5307G**  
Gild

**A** **MARKOS LARGE HANGING SHADE**  
ALEXA HAMPTON

**AH5215**  
H: 16.25" | W: 26" | Canopy: 6.5" Round  
Socket: 4 - E26 Keyless | Bulb: 4 - 60 A  
\* Item Includes 3.5 ft. of Chain

**B** **BASIL SMALL HANGING SHADE**  
ALEXA HAMPTON

**AH5216**  
H: 14.5" | W: 19" | Canopy: 6.5" Round  
Socket: 2 - E26 Keyless | Bulb: 2 - 75 A  
**Additional Options:**  
Gun Metal | Frosted Acrylic (GM)



**A** | **AH5215BZ**  
Bronze | Frosted Acrylic

**A** | **AH5215NB**  
Natural Brass | Frosted Acrylic



**A** | **AH5215BSL/G-FA**  
Burnished Silver Leaf | Gild | Frosted Acrylic

**A** | **AH5215G-FA**  
Gild | Frosted Acrylic



**A** | **AH5215PN**  
Polished Nickel | Frosted Acrylic



**B** | **AH5216PN**  
Polished Nickel | Frosted Acrylic



**B** | **AH5216NB**  
Natural Brass | Frosted Acrylic







**A** | **SL5820PN-NP**  
Polished Nickel | Natural Paper

**A** | **SQUARE TUBE HANGING SHADE**  
E. F. CHAPMAN  
  
**SL5820**  
H: 21" | W: 24" | Canopy: 5.75" Square  
Socket: 6 - E12 Candelabra | Bulb: 6 - 60 B  
Shade: 20" x 24" x 11"  
©EFC DESIGNS

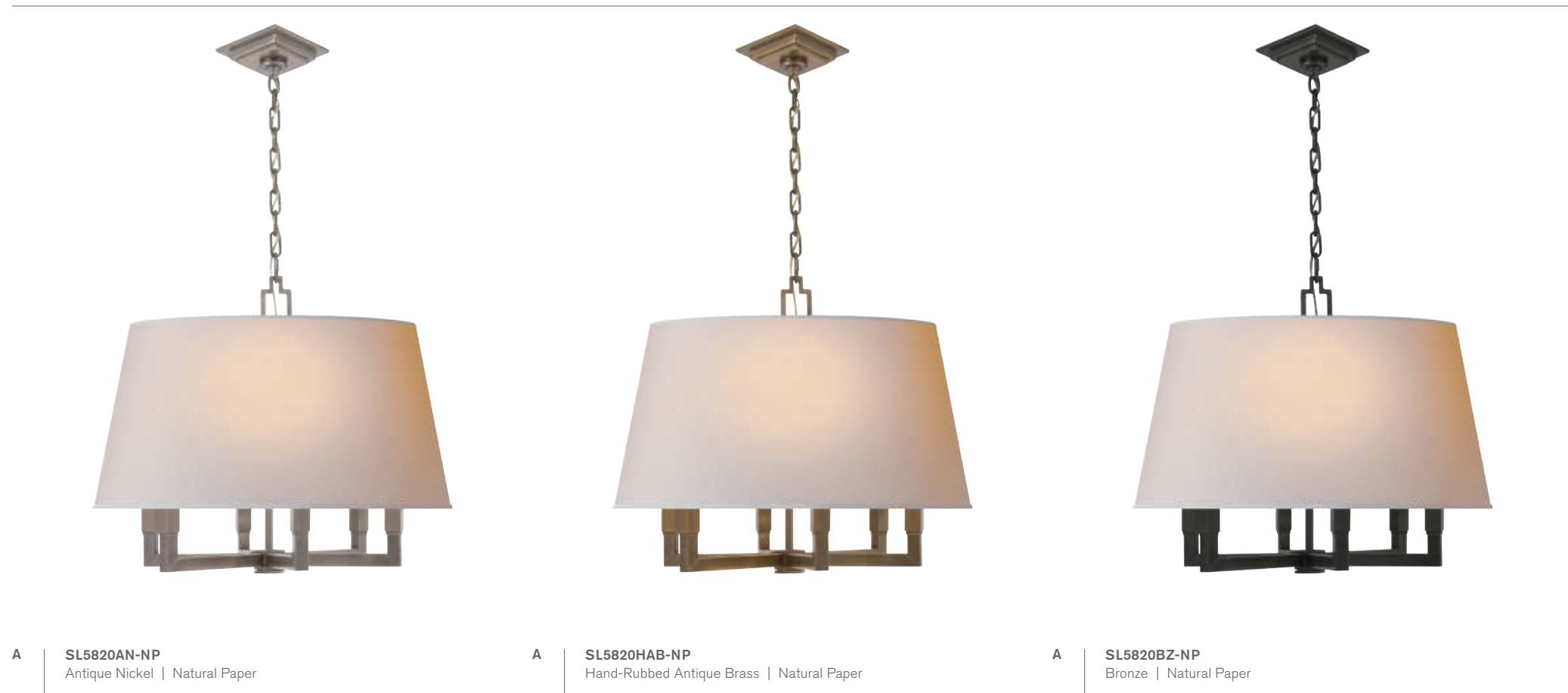

**A** | **SL5820AN-NP**  
Antique Nickel | Natural Paper

**A** | **SL5820HAB-NP**  
Hand-Rubbed Antique Brass | Natural Paper

**A** | **SL5820BZ-NP**  
Bronze | Natural Paper

**B** | **GRENOL MEDIUM HANGING SHADE**  
STUDIO VC  
  
**S5169**  
H: 31.75" | W: 25" | Canopy: 5" Round  
Socket: 6 - E12 Candelabra | Bulb: 6 - 40 B  
Shade: 22" x 25" x 16"

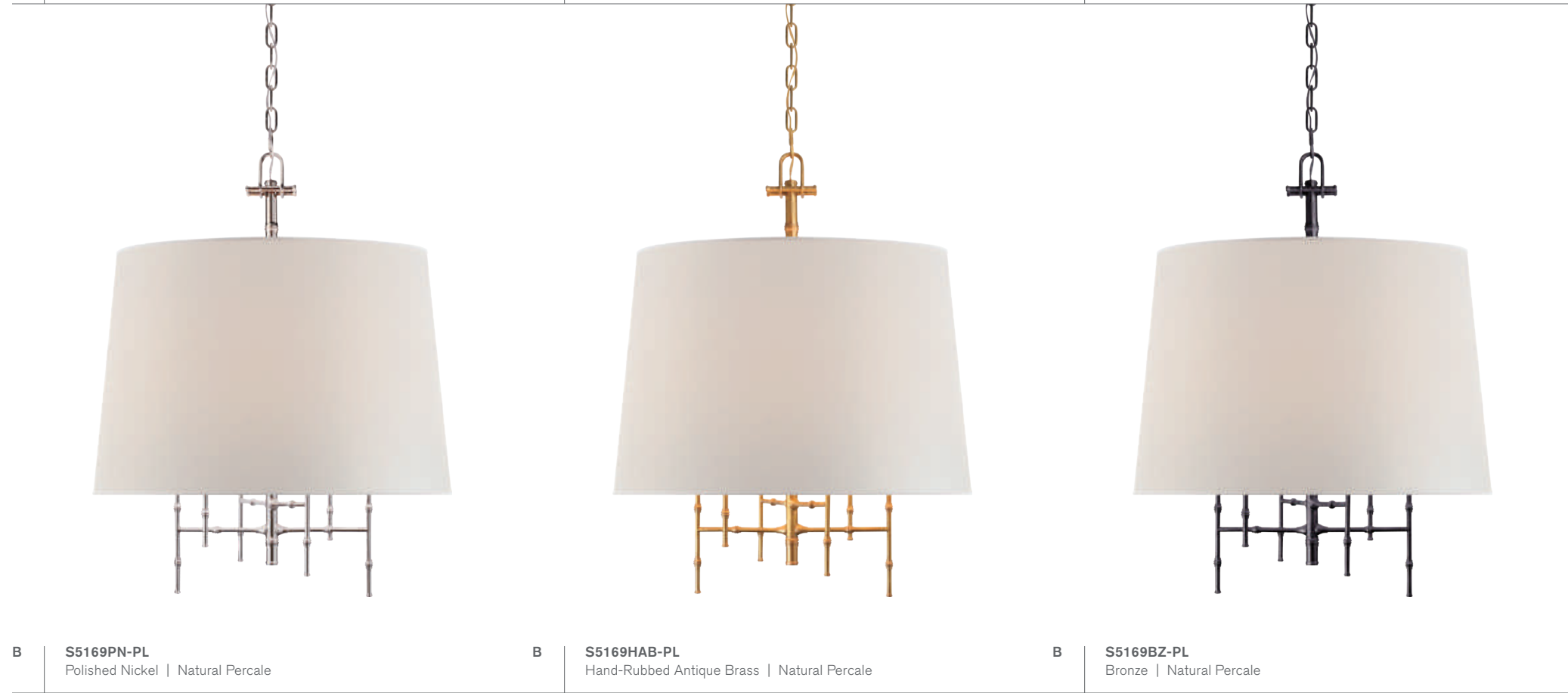

**B** | **S5169PN-PL**  
Polished Nickel | Natural Percalé

**B** | **S5169HAB-PL**  
Hand-Rubbed Antique Brass | Natural Percalé

**B** | **S5169BZ-PL**  
Bronze | Natural Percalé



**A** | **TOB5755AI-L**  
Aged Iron | Linen



**B** | **S5033BR-NP**  
Blackened Rust | Natural Paper



**C** | **S5030BR-NP**  
Blackened Rust | Natural Paper

opposite page

**A** | **PIETRO HANGING SHADE**  
THOMAS O'BRIEN

**TOB5755**  
H: 27" | W: 25" | Canopy: 5.75" Round  
Socket: 6 - E12 Candelabra | Bulb: 6 - 60 B  
Shade: 25" x 25" x 12"

**B** | **ASPEN LARGE CONICAL HANGING SHADE**  
IAN K. FOWLER

**S5033**  
H: 29" | W: 21" | Canopy: 6" Round  
Socket: E26 Keyless | Bulb: 75 A  
Shade: 12.25" x 20" x 11"

**C** | **ASPEN LARGE HANGING SHADE**  
IAN K. FOWLER

**S5030**  
H: 20.75" | W: 19.75" | Canopy: 6" Round  
Socket: 4 - E12 Candelabra | Bulb: 4 - 60 B  
Shade: 19" x 19.5" x 10"



**D** | **SP5020PN-NP**  
Polished Nickel | Natural Paper

**D** | **SP5020HAB-NP**  
Hand-Rubbed Antique Brass | Natural Paper

**D** | **SP5020BZ-NP**  
Bronze | Natural Paper



**E** | **BBL5023PWT-S**  
Pewter | Silk

**E** | **BBL5023SB-S**  
Soft Brass | Silk

**E** | **BBL5023BZ-S**  
Bronze | Silk

**D** | **DALSTON HANGING SHADE**  
J. RANDALL POWERS

**SP5020**  
H: 34.25" | W: 21.25" | Canopy: 5" Round  
Socket: 4 - E26 Keyless | Bulb: 4 - 60 A

**E** | **WESTPORT HANGING SHADE**  
BARBARA BARRY

**BBL5023**  
H: 39" | W: 18" | Canopy: 4.5" Round  
Socket: 3 - E26 Keyless | Bulb: 3 - 60 A  
Shade: 14" x 18" x 17.5"  
\* Cannot be Modified in Field  
\* Custom Height Available (25" Minimum)



**A** **TOB5011PN-NP**  
Polished Nickel | Natural Paper

**A** **TOB5011AN-NP**  
Antique Nickel | Natural Paper

**A** **TOB5011HAB-NP**  
Hand-Rubbed Antique Brass | Natural Paper

**A** **TOB5011HAB-NP/BT**  
Hand-Rubbed Antique Brass | Paper | Black Tape



**B** **BBL5030SS-L**  
Soft Silver | Linen

**B** **BBL5030PWT-L**  
Pewter | Linen

**B** **BBL5030SB-L**  
Soft Brass | Linen

**B** **BBL5030BZ-L**  
Bronze | Linen



**C** **CHC1526PN-NP**  
Polished Nickel | Crystal | Natural Paper



**C** **CHC1526AB-NP**  
Antique-Burnished Brass | Crystal | Natural Paper

**A** **REED HANGING SHADE**  
THOMAS O'BRIEN

**TOB5011**  
H: 29.5" | W: 22" | Canopy: 5.25" Round  
Socket: 2 - E26 Keyless | Bulb: 2 - 100 A  
Shade: 22" x 22" x 7.5"  
\* Cannot Be Modified In The Field  
\* Custom Height Available (14" Minimum)

**B** **WESTPORT LARGE HANGING SHADE**  
BARBARA BARRY

**BBL5030**  
H: 21" | W: 23" | Canopy: 7" Round  
Socket: 4 - E26 Keyless | Bulb: 4 - 60 A  
Shade: 21" x 23" x 16"

**C** **CRYSTAL STACKED BALL HANGING SHADE**  
E. F. CHAPMAN

**CHC1526**  
H: 28.5" | W: 30" | Canopy: 6.25" Round  
Socket: 6 - E12 Candelabra | Bulb: 6 - 60 C  
Shade: 24" x 30" x 14"  
**Additional Options:**  
Antique-Burnished Brass | Crystal | Natural Paper (AB-NP)  
©EFC DESIGNS



**A GROSVENOR SMALL HANGING SHADE**  
E. F. CHAPMAN

**CHC1480**  
H: 54.5" | W: 15" | Canopy: 6" Round  
Socket: 2 - E26 Keyless | Bulb: 2 - 75 A  
Shade: 12" x 15" x 10.5"  
\* Custom Height Available (19" Minimum)  
©EFC DESIGNS

**B GROSVENOR LARGE HANGING SHADE**  
E. F. CHAPMAN

**CHC1483**  
H: 20.5" | W: 24" | Canopy: 6" Round  
Socket: 3 - E26 Keyless | Bulb: 3 - 60 A  
Shade: 20" x 24" x 15"  
©EFC DESIGNS

**A CHC1480PN-L**  
Polished Nickel | Linen

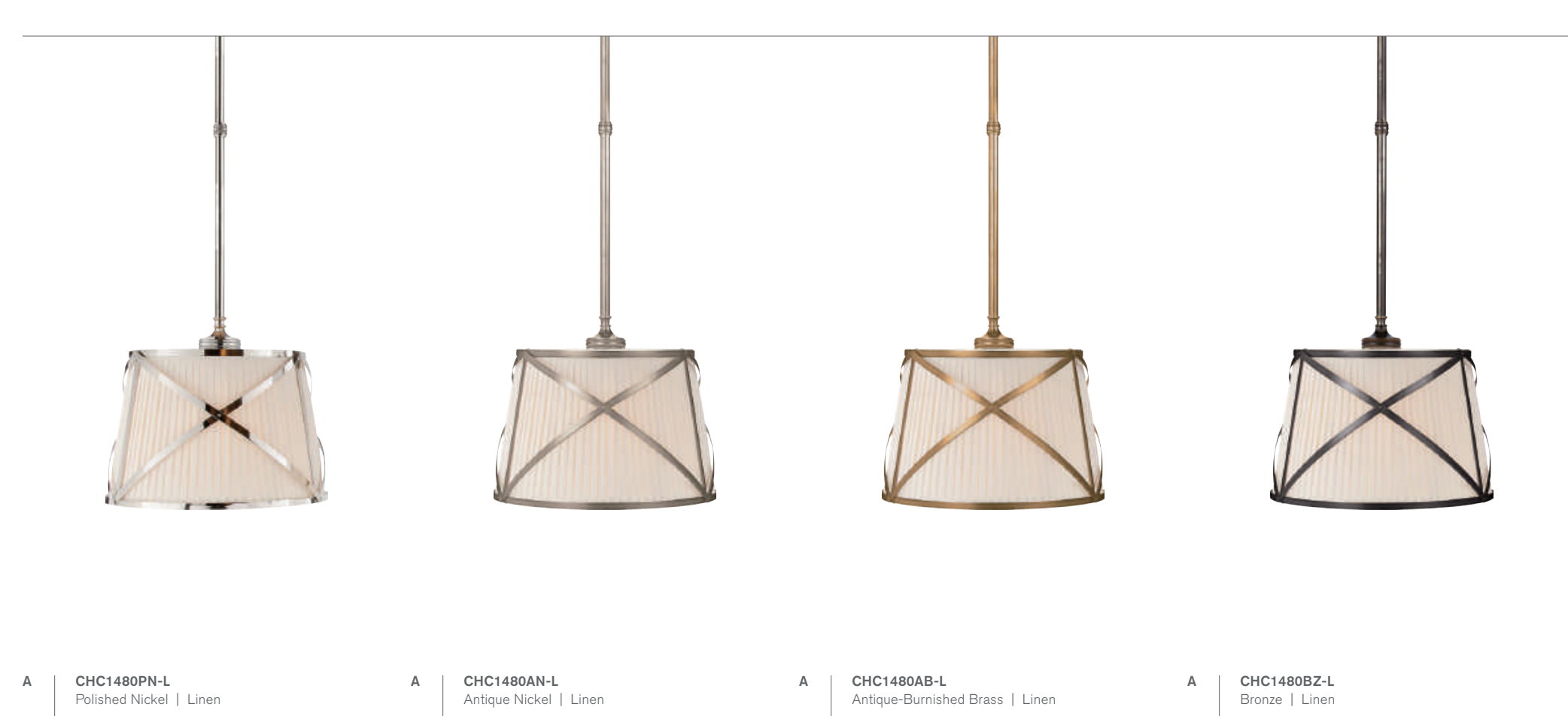

**A CHC1480PN-L**  
Polished Nickel | Linen

**A CHC1480AN-L**  
Antique Nickel | Linen

**A CHC1480AB-L**  
Antique-Burnished Brass | Linen

**A CHC1480BZ-L**  
Bronze | Linen

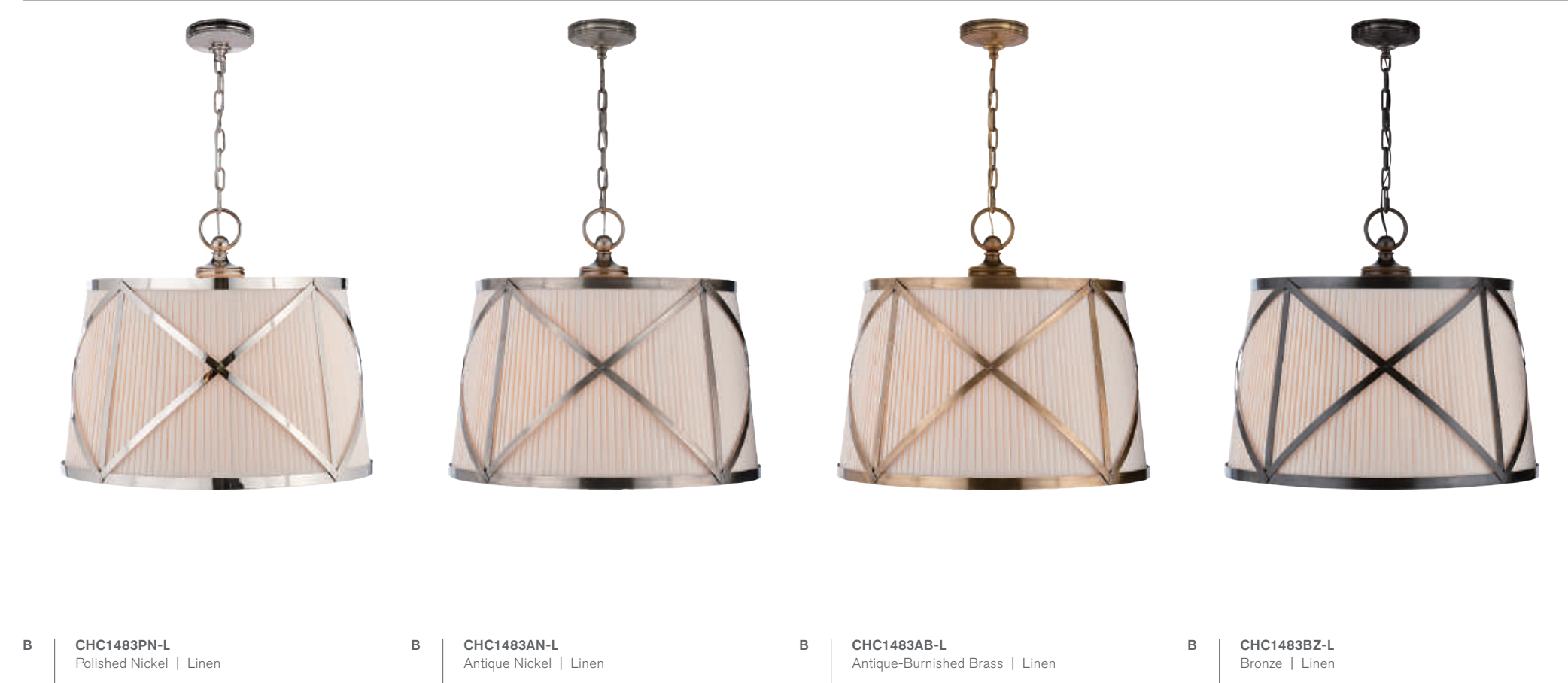

**B CHC1483PN-L**  
Polished Nickel | Linen

**B CHC1483AN-L**  
Antique Nickel | Linen

**B CHC1483AB-L**  
Antique-Burnished Brass | Linen

**B CHC1483BZ-L**  
Bronze | Linen



A SK5536AI-L  
Aged Iron | Linen



A SK5536GI-L  
Gilded Iron | Linen



A SK5536BSL-L  
Burnished Silver Leaf | Linen



B SK5537AI-L  
Aged Iron | Linen



B SK5537GI-L  
Gilded Iron | Linen



B SK5537BSL-L  
Burnished Silver Leaf | Linen



A SK5536BSL-L  
Burnished Silver Leaf | Linen

A ALEXANDRA MEDIUM HANGING SHADE  
SUZANNE KASLER

SK5536  
H: 15.25" | W: 24.75" | Canopy: 5" Round  
Socket: 4 - E26 Keyless | Bulb: 4 - 60 A  
Shade: 22.5" x 22.5" x 12.25" Round

B ALEXANDRA LARGE HANGING SHADE  
SUZANNE KASLER

SK5537  
H: 22.5" | W: 37" | Canopy: 5" Round  
Socket: 4 - E26 Keyless | Bulb: 4 - 60 A  
Shade: 33.5" x 33.5" x 19" Round



**A** **CAROUSEL SMALL TAPERED LANTERN**  
BARBARA BARRY

**BBL5012**  
H: 46.25" | Fixture: 12" H | W: 9.5"  
Canopy: 5" Round  
Socket: E26 Keyless | Bulb: 60 A  
**Additional Options:**  
Bronze | Linen (BZ-L)



**D** **CAROUSEL SMALL OBLONG LANTERN**  
BARBARA BARRY

**BBL5008**  
H: 51.5" | Fixture: 17.25" H | W: 11"  
Canopy: 5" Round  
Socket: E26 Keyless | Bulb: 60 A



**E** **CAROUSEL MEDIUM OBLONG LANTERN**  
BARBARA BARRY

**BBL5009**  
H: 59" | Fixture: 25" H | W: 16.25"  
Canopy: 5" Round  
Socket: E26 Keyless | Bulb: 60 A

**A** **BBL5012PN-L**  
Polished Nickel | Linen



**B** **CAROUSEL MEDIUM TAPERED LANTERN**  
BARBARA BARRY

**BBL5013**  
H: 62.5" | Fixture: 27.5" H | W: 23.75"  
Canopy: 5" Round  
Socket: 2 - E26 Keyless | Bulb: 2 - 60 A  
**Additional Options:**  
Soft Brass | Linen (SB-L)  
\* Custom Height Available (31.5" Minimum)

**B** **BBL5013PN-L**  
Polished Nickel | Linen



**B** **BBL5013BZ-L**  
Bronze | Linen



**C** **CAROUSEL LARGE DRUM LANTERN**  
BARBARA BARRY

**BBL5014**  
O/A H: 52.5" | Fixture: 18.5" H | W: 24"  
Canopy: 5" Round  
Socket: 2 - E26 Keyless | Bulb: 2 - 60 A  
**Additional Options:**  
Polished Nickel | Linen (PN-L)

**A** **BBL5012SB-L**  
Soft Brass | Linen

**C** **BBL5014SB-L**  
Soft Brass | Linen

**C** **BBL5014BZ-L**  
Bronze | Linen

**D** **BBL5008PN-L**  
Polished Nickel | Linen



**D** **BBL5008SB-L**  
Soft Brass | Linen



**D** **BBL5008BZ-L**  
Bronze | Linen



**E** **BBL5009PN-L**  
Polished Nickel | Linen

**E** **BBL5009SB-L**  
Soft Brass | Linen

**E** **BBL5009BZ-L**  
Bronze | Linen



**A PAPER MOON LARGE HANGING SHADE**  
BARBARA BARRY

**BBL5123**  
H: 30.5" - 113" | Fixture: 16" H | W: 36"  
Canopy: 5" Round  
Socket: E26 Keyless | Bulb: 75 A  
**Additional Options:**  
Bronze | Rice Paper (BZ-RP)  
Polished Nickel | Rice Paper (PN-RP)

**B PAPER MOON MEDIUM HANGING SHADE**  
BARBARA BARRY

**BBL5122**  
H: 26.5" - 113" | Fixture: 12" H | W: 26"  
Canopy: 5" Round  
Socket: E26 Keyless | Bulb: 75 A  
**Additional Options:**  
Soft Brass | Rice Paper (SB-RP)



**C ARN5033HAB-L**  
Hand-Rubbed Antique Brass | Linen

**D FORZA SMALL GATHERED LANTERN**  
KELLY WEARSTLER

**KW5315**  
H: 40.5" | Fixture: 25.75" H | W: 11"  
Canopy: 7" Round  
Socket: E26 Keyless | Bulb: 60 T  
Shade: 11" x 11" x 18"



**D KW5315PN-L**  
Polished Nickel | Linen

**D KW5315AB-L**  
Antique-Burnished Brass | Linen

**D KW5315BZ-L**  
Bronze | Linen



**B BBL5122PN-RP**  
Polished Nickel | Rice Paper

**B BBL5122BZ-RP**  
Bronze | Rice Paper

**C CLARKSON SMALL SINGLE PENDANT**  
AERIN

**ARN5033**  
H: 44.75" | Fixture: 16" H | W: 9.75"  
Canopy: 4.75" Round  
Socket: E26 Keyless | Bulb: 2 - 75 A  
Shade: 5.25" x 9.75" x 11"  
\* Custom Height Available (23" Minimum)



**C ARN5033PN-L**  
Polished Nickel | Linen

**E LABAN HANGING SHADE**  
AERIN

**ARN5213**  
H: 21" | W: 18.25" | Canopy: 4.5" Oct.  
Socket: 4 - E12 Candelabra | Bulb: 4 - 60 C  
Shade: 19.75" x 19.75" x 18" Oct.  
**Additional Options:**  
Polished Nickel | Linen (PN-L)



**E ARN5213PN-L**  
Polished Nickel | Linen

**E ARN5213HAB-L**  
Hand-Rubbed Antique Brass | Linen

**E ARN5213BZ-L**  
Bronze | Linen



A BBL5033SS-S  
Soft Silver | Silk

A BBL5033PWT-S  
Pewter | Silk

A BBL5033SB-S  
Soft Brass | Silk

A BBL5033BZ-S  
Bronze | Silk

opposite page

A PERFECT PLEAT TALL HANGING SHADE  
BARBARA BARRY

BBL5033  
H: 25.5" | W: 13" | Canopy: 6.5" Round  
Socket: 2 - E26 Keyless | Bulb: 2 - 60 A  
Shade: 13" x 13" x 21" Hardback

B PERFECT PLEAT HANGING SHADE  
BARBARA BARRY

BBL5032  
H: 21.25" | W: 23" | Canopy: 6.5" Round  
Socket: 2 - E26 Keyless | Bulb: 2 - 75 A  
Shade: 22" x 23" x 18.5" Hardback



C BBL5031SS-S  
Soft Silver | Silk

C BBL5031SB-S  
Soft Brass | Silk



B BBL5032SS-S  
Soft Silver | Silk

B BBL5032PWT-S  
Pewter | Silk

B BBL5032SB-S  
Soft Brass | Silk

B BBL5032BZ-S  
Bronze | Silk

C PERFECT PLEAT OVAL HANGING SHADE  
BARBARA BARRY

BBL5031  
H: 19" | W: 36" | Canopy: 5" x 23.5" Rec.  
Socket: 4 - E26 Keyless | Bulb: 4 - 40 A  
Shade: 35" x 36" x 19.25" Oval



C BBL5031PWT-S  
Pewter | Silk

C BBL5031BZ-S  
Bronze | Silk





**A** **BBL5016SB-S**  
Soft Brass | Silk

**A** **SIMPLE SCALLOP SEMI-FLUSH MOUNT**  
BARBARA BARRY

**BBL5016**  
H: 21.5" | W: 15.75" | Canopy: 7" Round  
Socket: 3 - E12 Candelabra | Bulb: 3 - 60 B  
Shade: 14" x 15.75" x 11.5"  
\* Custom Height Available (16.5" Minimum)

**B** **SIMPLE SCALLOP LARGE HANGING SHADE**  
BARBARA BARRY

**BBL5015**  
H: 21" | W: 25" | Canopy: 8.5" Round  
Socket: 5 - E12 Candelabra | Bulb: 5 - 60 B  
Shade: 22" x 25" x 17.5"

**C** **SIMPLE BANDED HANGING SHADE**  
BARBARA BARRY

**BBL5110**  
H: 20" | W: 24" | Canopy: 6.5" Round  
Socket: 2 - E26 Keyless | Bulb: 2 - 60 A  
Shade: 22" x 24" x 20"

**A** **BBL5016SS-S**  
Soft Silver | Silk



**B** **BBL5015SS-S**  
Soft Silver | Silk



**B** **BBL5015SB-S**  
Soft Brass | Silk



**B** **BBL5015BZ-S**  
Bronze | Silk



**C** **BBL5110SS-S**  
Soft Silver | Silk



**C** **BBL5110SB-S**  
Soft Brass | Silk



**C** **BBL5110BZ-S**  
Bronze | Silk



**A REFLECTION SEMI-FLUSH MOUNT**  
BARBARA BARRY

**BBL5024**  
H: 12" - 14" | Fixture: 6.75" H | W: 15"  
Canopy: 10" Round  
Socket: 2 - E26 Keyless | Bulb: 2 - 75 A  
Shade: 15" x 15" x 6" Hardback  
\* Custom Height Available

**B REFLECTION LARGE HANGING SHADE**  
BARBARA BARRY

**BBL5025**  
H: 40" | W: 24" | Canopy: 10" Round  
Socket: 4 - E26 Keyless | Bulb: 4 - 75 A  
Shade: 24" x 24" x 13" Hardback  
\* Knob is for Decorative Purposes  
\* Custom Height Available (23" Minimum)

**A BBL5024SS-S**  
Soft Silver | Silk

**A BBL5024SB-S**  
Soft Brass | Silk

**A BBL5024BZ-S**  
Bronze | Silk



**B BBL5025SS-S**  
Soft Silver | Silk

**B BBL5025SB-S**  
Soft Brass | Silk

**B BBL5025BZ-S**  
Soft Bronze | Silk

opposite page

**C HOOP MEDIUM**  
BARBARA BARRY

**BBL5115**  
H: 28" - 155" | Fixture: 13.5" H | W: 26"  
Canopy: 6" Round  
Socket: 2 - E26 Keyless | Bulb: 2 - 60 A  
Shade: 26" x 20.5" x 13.5"  
**Additional Options:**  
Bronze | Linen (BZ-L)

**A BBL5024SS-S**  
Soft Silver | Silk



**C BBL5115SS-L**  
Soft Silver | Linen



**C BBL5115SB-L**  
Soft Brass | Linen



CEILING | PENDANTS



**B** | **ARN5351PW**  
Plaster White | Gild Interior

**C** | **ARN5352PW**  
Plaster White | Gild Interior

**A** | **ARN5350PW**  
Plaster White | Gild Interior

**A** | **AGNES SMALL PENDANT**  
AERIN

**ARN5350**  
H: 50.25" | Fixture: 13.5" H | W: 10"  
Canopy: 4.25" Round  
Socket: E26 Keyless | Bulb: 75 A  
**Additional Options:**  
Gild | White Interior (G)  
Matte Black | Gild Interior (MBK)  
\* Cannot be Modified in the Field  
\* Custom Height Available (19" Minimum)

**B** | **AGNES MEDIUM PENDANT**  
AERIN

**ARN5351**  
H: 59.5" | Fixture: 22.75" H | W: 18"  
Canopy: 4.25" Round  
Socket: E26 Keyless | Bulb: 75 A  
**Additional Options:**  
Burnished Silver Leaf | White Interior (BSL)  
\* Cannot be Modified in the Field  
\* Custom Height Available (30" Minimum)

**C** | **AGNES LARGE PENDANT**  
AERIN

**ARN5352**  
H: 50.5" | Fixture: 13.5" H | W: 21"  
Canopy: 4.25" Round  
Socket: E26 Keyless | Bulb: 75 A  
\* Cannot be Modified in the Field  
\* Custom Height Available (21" Minimum)



**A** | **ARN5350PW**  
Plaster White | Gild Interior

**A** | **ARN5350BSL**  
Burnished Silver Leaf | White Interior

**B** | **ARN5351G**  
Gild | White Interior

**B** | **ARN5351MBK**  
Matte Black | Gild Interior



**C** | **ARN5352PW**  
Plaster White | Gild Interior

**C** | **ARN5352BSL**  
Burnished Silver Leaf | White Interior

**C** | **ARN5352G**  
Gild | White Interior

**C** | **ARN5352MBK**  
Matte Black | Gild Interior



**A** | **ARN5045PW/G**  
Plaster White | Gild

**A** | **ARN5045BSL**  
Burnished Silver Leaf



**B** | **KW5509AB/AW-FA**  
White | Brass | White Marble | Gild Interior



**B** | **KW5509AB/BLK-FA**  
Black | Brass | Black Marble | Gild Interior

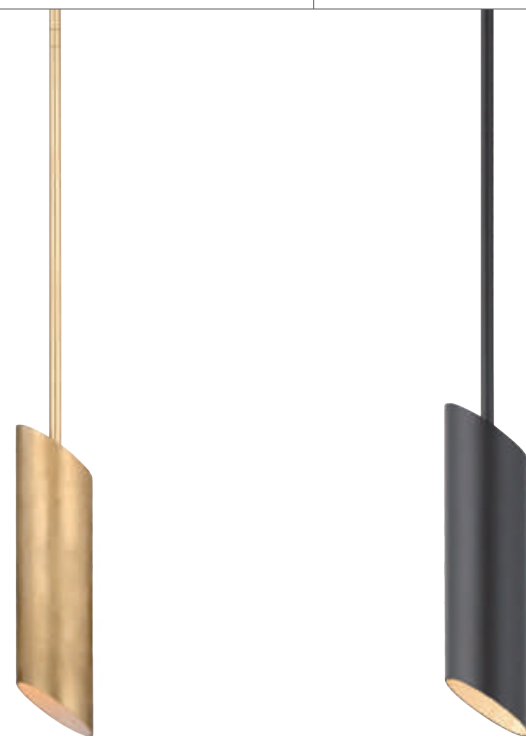

**A** | **ARN5045G**  
Gild

**A** | **ARN5045BLK/G**  
Black | Gild



**C** | **KW5515AB/WM-WHT**  
White | Brass | White Marble | Gild Interior



**C** | **KW5515AB/BM-BLK**  
Black | Brass | Black Marble | Gild Interior

**A** | **TOURAIN SMALL PENDANT**  
AERIN  
  
**ARN5045**  
H: 45.25" | Fixture: 13" H | W: 3.25"  
Canopy: 5" Round  
Socket: E26 Keyless | Bulb: 40 T  
\* Custom Height Available (17.75" Minimum)

**B** | **CLEO MEDIUM PENDANT**  
KELLY WEARSTLER  
  
**KW5509**  
H: 50.5" | Fixture: 16" H | W: 20"  
Canopy: 4.5" Round  
Socket: 3 - E26 Keyless | Bulb: 3 - 5.5 LED B  
\* Frosted Acrylic Diffuser  
\* Cannot Be Modified in the Field  
\* Custom Height Available (27" Minimum)

**C** | **CLEO LARGE PENDANT**  
KELLY WEARSTLER  
  
**KW5515**  
O/A H: 50" | Fixture: 24" H | W: 30"  
Canopy: 6.5" Round  
Socket: 3 - E26 Keyless | Bulb: 3 - 40 A  
\* Frosted Acrylic Diffuser  
\* Custom Height Available (39" Minimum)



**B** | **KW5509AB/AW-FA**  
White | Brass | White Marble | Gild Interior



**A** **TOB5089AN-NP**  
Antique Nickel | Natural Paper

**A** **TOB5089HAB-AW**  
Brass | Antique White | Brass Interior

**B** **TOB5090BZ/HAB-HAB**  
Bronze | Brass | Brass Interior

**B** **TOB5090HAB-BZ**  
Brass | Bronze | White Interior



**C** **TOB5091HAB-NP**  
Brass | Natural Paper

**C** **TOB5091BZ/HAB-AW**  
Bronze | Brass | Antique White | Brass Interior

**C** **TOB5091HAB-HAB**  
Brass | Brass | White Interior

**C** **TOB5091BZ-BZ**  
Bronze | Bronze | White Interior



**D** **TOB5014AN-AN**  
Antique Nickel | White Interior

**A** **GOODMAN PETITE PENDANT**  
THOMAS O'BRIEN  
  
**TOB5089**  
H: 38" | Fixture: 12" H | W: 10"  
Canopy: 5.25" Round  
Socket: E12 Candelabra | Bulb: 60 C  
Shade: 3" x 9.5" x 9.25"  
\* Custom Height Available (15" Minimum)

**B** **GOODMAN SMALL PENDANT**  
THOMAS O'BRIEN  
  
**TOB5090**  
H: 42" | W: 15" | Canopy: 5.25" Round  
Socket: E26 Keyless | Bulb: 100 A  
Shade: 4.75" x 15" x 12.75"  
\* Custom Height Available (17" Minimum)

**C** **GOODMAN MEDIUM PENDANT**  
THOMAS O'BRIEN  
  
**TOB5091**  
H: 43" | W: 18" | Canopy: 5.25" Round  
Socket: E26 Keyless | Bulb: 100 A  
Shade: 6.5" x 18" x 15.5"  
\* Custom Height Available (20" Minimum)

**D** **GOODMAN LARGE PENDANT**  
THOMAS O'BRIEN  
  
**TOB5014**  
H: 48.5" | W: 24.5" | Canopy: 5.25" Round  
Socket: 2 - E26 Keyless | Bulb: 2 - 100 A  
Shade: 7.5" x 24" x 22.5"  
\* Custom Height Available (26" Minimum)

**Available Options for Goodman:**  
Antique Nickel | Antique Nickel (AN-AN)  
Antique Nickel | Natural Paper (AN-NP)  
Bronze | Antique White (BZ-AW)  
Bronze | Brass (BZ-HAB)  
Bronze | Brass | Antique White (BZ/HAB-AW)  
Bronze | Brass | Bronze (BZ/HAB-BZ)  
Bronze | Brass (BZ/HAB-HAB)  
Bronze | Brass | Natural Paper | Blk Tape (BZ/HAB-NP/BT)  
Bronze | Natural Paper | Blk Tape (BZ-NP/BT)  
Bronze | Bronze (BZ-BZ)  
Hand-Rubbed Antique Brass | Antique White (HAB-AW)  
Hand-Rubbed Antique Brass | Brass (HAB-HAB)  
Hand-Rubbed Antique Brass | Bronze (HAB-BZ)  
Hand-Rubbed Antique Brass | Natural Paper (HAB-NP)  
Hand-Rubbed Antique Brass | Paper | Blk Tape (HAB-NP/BT)



- A LIMOGES SMALL PENDANT**  
SUZANNE KASLER  
  
**SK5360**  
Fixture: 19" H | W: 6.75" | Canopy: 5.5" Round  
Socket: E26 Keyless | Bulb: 60 T
- B LIMOGES MEDIUM PENDANT**  
SUZANNE KASLER  
  
**SK5362**  
Fixture: 20.5" H | W: 14.25" | Canopy: 5.5" Round  
Socket: E26 Keyless | Bulb: 60 A
- C LIMOGES LARGE PENDANT**  
SUZANNE KASLER  
  
**SK5363**  
Fixture: 16.5" H | W: 16.5" | Canopy: 5.5" Round  
Socket: E26 Keyless | Bulb: 75 A
- D LIMOGES GRANDE PENDANT**  
SUZANNE KASLER  
  
**SK5364**  
H: 19.75" | W: 24" | Canopy: 5.5" Round  
Socket: E26 Keyless | Bulb: 75 A



**A SK5360NR-PW**  
Natural Rust | Plaster White

**B SK5362NR-AI**  
Natural Rust | Aged Iron

**C SK5363NR-AI**  
Natural Rust | Aged Iron

**D SK5364NR-AI**  
Natural Rust | Aged Iron

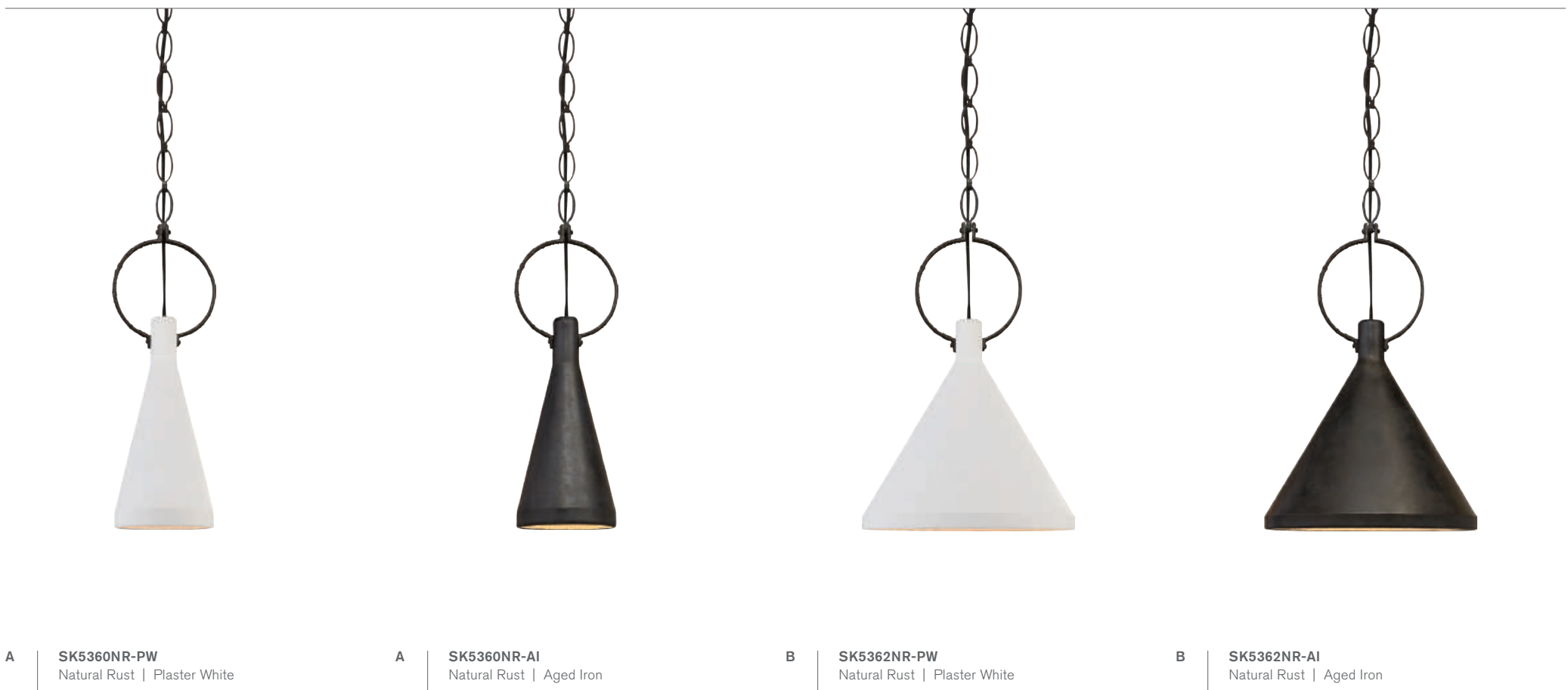

**A SK5360NR-PW**  
Natural Rust | Plaster White

**A SK5360NR-AI**  
Natural Rust | Aged Iron

**B SK5362NR-PW**  
Natural Rust | Plaster White

**B SK5362NR-AI**  
Natural Rust | Aged Iron

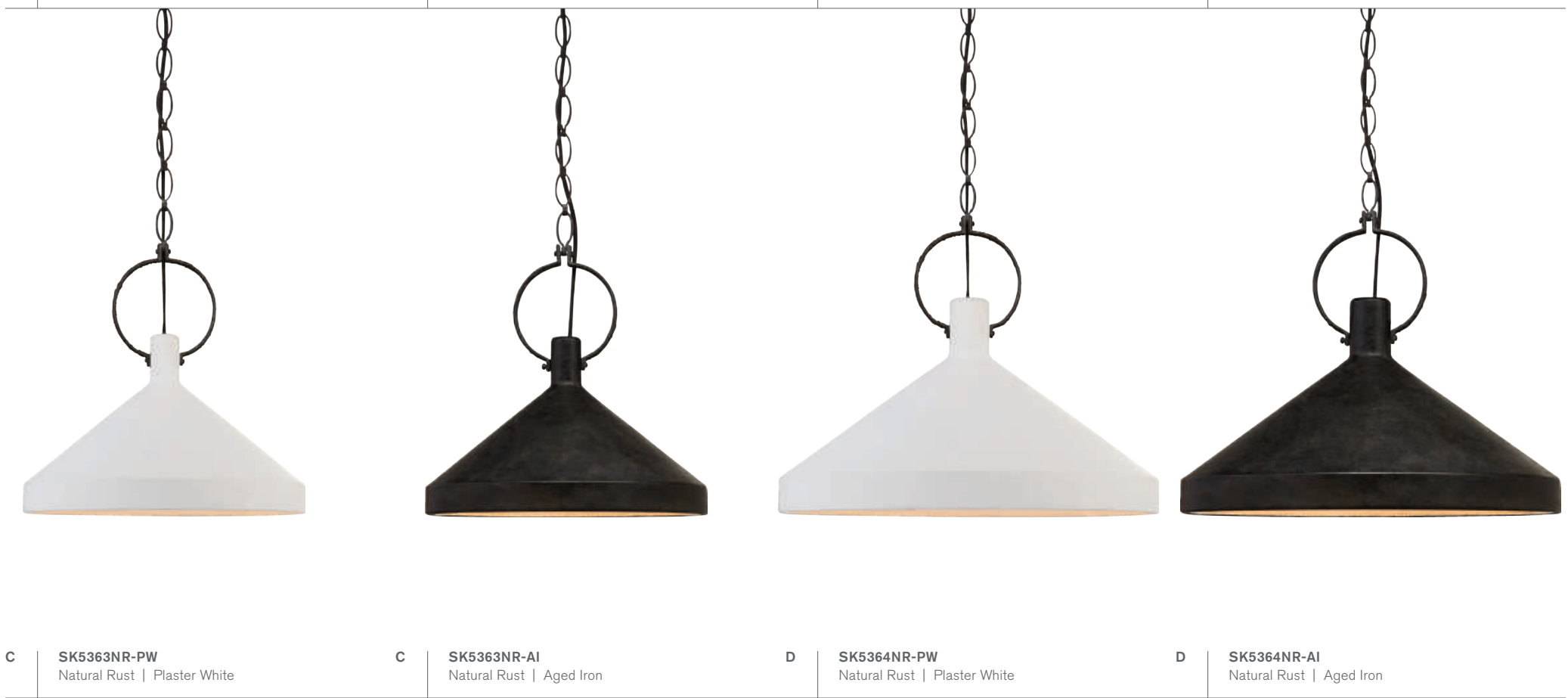

**C SK5363NR-PW**  
Natural Rust | Plaster White

**C SK5363NR-AI**  
Natural Rust | Aged Iron

**D SK5364NR-PW**  
Natural Rust | Plaster White

**D SK5364NR-AI**  
Natural Rust | Aged Iron



**A** | **CHC5240PN-PN**  
Polished Nickel | Polished Nickel

**A** | **CHC5240PN-WHT**  
Polished Nickel | Matte White

**A** | **CHC5240AN-AN**  
Antique Nickel | Antique Nickel

**A** | **CHC5240AN-BLK**  
Antique Nickel | Matte Black



**B** | **CHC5245AB-WHT**  
Antique-Burnished Brass | Matte White

**B** | **CHC5245AB-BLK**  
Antique-Burnished Brass | Matte Black

**B** | **CHC5245AN-BLK**  
Antique Nickel | Matte Black

**A** | **ALBORG SMALL STACKED PENDANT**  
E. F. CHAPMAN

**CHC5240**  
H: 15" | W: 10" | Canopy: 5.75" Round  
Socket: E26 Keyless | Bulb: 60 A  
**Additional Options:**  
Antique-Burnished Brass | Matte Black (AB-BLK)  
Antique-Burnished Brass | Matte White (AB-WHT)  
©EFC DESIGNS

**B** | **CHC5245AN-AN**  
Antique Nickel | Antique Nickel

**A** | **CHC5240AN-BLK**  
Antique Nickel | Matte Black



**B** | **ALBORG LARGE STACKED PENDANT**  
E. F. CHAPMAN

**CHC5245**  
H: 15.5" | W: 24" | Canopy: 5.75" Round  
Socket: E26 Keyless | Bulb: 75 A  
**Additional Options:**  
Polished Nickel | Polished Nickel (PN-PN)  
Polished Nickel | Matte White (PN-WHT)  
©EFC DESIGNS





**A** | **S5640PN-WHT**  
Polished Nickel | Matte White

**A** | **S5640HAB-WHT**  
Hand-Rubbed Antique Brass | Matte White

**C** | **ARN5032PN/WHT**  
Polished Nickel | White

**C** | **ARN5032PN/BLK**  
Polished Nickel | Black



**B** | **S5641PN-WHT**  
Polished Nickel | Matte White

**B** | **S5641HAB-WHT**  
Hand-Rubbed Antique Brass | Matte White

**C** | **ARN5032HAB/WHT**  
Hand-Rubbed Antique Brass | White

**C** | **ARN5032HAB/BLK**  
Hand-Rubbed Antique Brass | Black

opposite page

**A** | **LIAM SMALL CONICAL PENDANT**  
STUDIO VC

**S5640**  
H: 49.75" | Fixture: 14.5" H | W: 10.25"  
Canopy: 4.75" Round  
Socket: E26 Keyless | Bulb: 60 A  
**Additional Options:**  
Polished Nickel | Metallic Black (PN-MTB)  
\* Custom Height Available (23" Minimum)

**B** | **LIAM MEDIUM CONICAL PENDANT**  
STUDIO VC

**S5641**  
O/A H: 50" | Fixture: 18.5" H | W: 15"  
Canopy: 4.75" Round  
Socket: E26 Keyless | Bulb: 60 A  
**Additional Options:**  
Polished Nickel | Metallic Black (PN-MTB)  
\* Custom Height Available (27" Minimum)

**C** | **CLARKSON MEDIUM NARROW PENDANT**  
AERIN

**ARN5032**  
H: 54" | Fixture: 18" H | W: 4.75"  
Canopy: 4.75" Round  
Socket: 2 - E12 Candelabra | Bulb: 2 - 40 B  
**Additional Options:**  
Polished Nickel | Polished Nickel (PN/PN)  
\* Custom Height Available (23" Minimum)

**D** | **UTOPIA SMALL PENDANT**  
KELLY WEARSTLER

**KW5531**  
H: 49.5" | Fixture: 14.25" H | W: 4"  
Canopy: 4.5" Round  
Socket: E26 Keyless | Bulb: 40 T  
\* Custom Height Available (17.5" Minimum)

**E** | **UTOPIA MEDIUM PENDANT**  
KELLY WEARSTLER

**KW5533**  
H: 53.25" | Fixture: 18" H | W: 5"  
Canopy: 4.5" Round  
Socket: E26 Keyless | Bulb: 40 T  
\* Custom Height Available (21.25" Minimum)



**D** | **KW5531PN-WG**  
Polished Nickel | White Glass

**D** | **KW5531G-WG**  
Gild | White Glass

**D** | **KW5531AI-WG**  
Aged Iron | White Glass



**E** | **KW5533PN-WG**  
Polished Nickel | White Glass

**E** | **KW5533G-WG**  
Gild | White Glass

**E** | **KW5533AI-WG**  
Aged Iron | White Glass



A | **PB5005PN**  
Polished Nickel

A | **PB5005NB**  
Natural Brass

A | **PB5005MBK**  
Matte Black

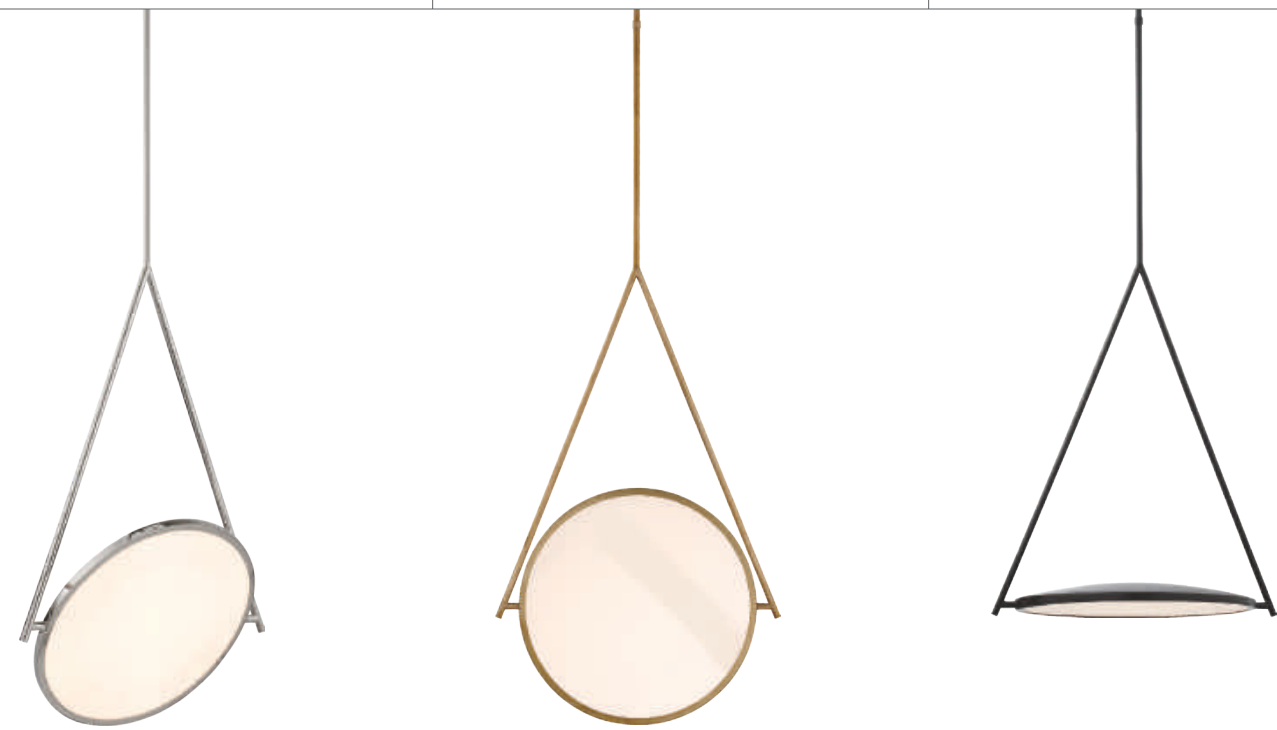

B | **PB5006PN**  
Polished Nickel

B | **PB5006NB**  
Natural Brass

B | **PB5006MBK**  
Matte Black

**A** | **DOT STANCE 13" ROTATING PENDANT**  
PETER BRISTOL

**PB5005**  
H: 62" | Fixture: 26" H | W: 16.25"  
Canopy: 5.25" Round  
LED: 18w  
\* Custom Height Available (30" Minimum)

**B** | **DOT STANCE 16" ROTATING PENDANT**  
PETER BRISTOL

**PB5006**  
H: 67" | Fixture: 33.5" H | W: 19"  
Canopy: 6" Round  
LED: 24w  
\* Custom Height Available (35" Minimum)

opposite page

**C** | **ORBIT 16" SWIVELING PENDANT**  
PETER BRISTOL

**PB5115**  
H: 55" | Fixture: 19.25" H | W: 19"  
Canopy: 5.25" Round  
LED: 41w  
**Available Options:**  
Antique Nickel (AN)  
Natural Brass (NB)  
\* Custom Height Available (30" Minimum)



A | **PB5005MBK**  
Matte Black



C | **PB5115PN**  
Polished Nickel



C | **PB5115BZ**  
Bronze



**A DOT 9" PENDANT**  
PETER BRISTOL

**PB5002**  
H: 39.5" | Fixture: 4.5" H | W: 9.5"  
Canopy: 6" Round | LED: 7.5w  
\* Custom Height Available (11" Minimum)

**C DOT 16" PENDANT**  
PETER BRISTOL

**PB5001**  
O/A H: 41" | Fixture: 6.5" H | W: 16.5"  
Canopy: 6" Round | LED: 24w  
\* Custom Height Available (11" Minimum)



**A PB5002PN**  
Polished Nickel

**A PB5002NB**  
Natural Brass

**A PB5002MBK**  
Matte Black



**B DOT 13" PENDANT**  
PETER BRISTOL

**PB5000**  
O/A H: 41" | Fixture: 6.5" H | W: 13.5"  
Canopy: 6" Round | LED: 18w  
\* Custom Height Available (11" Minimum)

**D DOT 22" PENDANT**  
PETER BRISTOL

**PB5003**  
H: 42.5" | Fixture: 7.5" H | W: 23"  
Canopy: 6" Round | LED: 41w  
**Additional Options:**  
Polished Nickel (PN)  
\* Custom Height Available (12" Minimum)

**C PB5001PN**  
Polished Nickel

**C PB5001NB**  
Natural Brass

**C PB5001MBK**  
Matte Black



**B PB5000PN**  
Polished Nickel

**B PB5000NB**  
Natural Brass

**B PB5000MBK**  
Matte Black

**D PB5003NB**  
Natural Brass

**D PB5003MBK**  
Matte Black



**A** | **PB5111MBK**  
Matte Black



**A** | **PB5111MBK**  
Matte Black



opposite page

**A** | **INTERLACE EXPANDABLE CHANDELIER**  
PETER BRISTOL

**PB5111**  
H: 43" - 74.5" | W: 8" - 30" | Canopy: 5.25" Round  
LED: 34w  
\* Cannot be Installed Less than 43" O/A Height  
without Custom Order



**B** | **PB5010STW**  
Stone White

**B** | **PB5010SC**  
Soft Copper

**B** | **PB5010STB**  
Stone Black

**C** | **PB5020STW**  
Stone White

**C** | **PB5020STG**  
Stone Gray

**C** | **PB5020STB**  
Stone Black

**B** | **FARMHOUSE DOT 13" PENDANT**  
PETER BRISTOL

**PB5010**  
Fixture: 7.25" H | W: 14" | Canopy: 6" Round  
LED: 18w  
**Additional Options:**  
Soft Copper (SC)

**C** | **60/40 DOT 16" PENDANT**  
PETER BRISTOL

**PB5020**  
Fixture: 4.25" H | W: 19.75" | Canopy: 6" Round  
LED: 37w

**D** | **60/40 DOT 22" PENDANT**  
PETER BRISTOL

**PB5022**  
Fixture: 8" H | W: 25.75" | Canopy: 6" Round  
LED: 72w

**D** | **PB5022STW**  
Stone White

**D** | **PB5022STG**  
Stone Gray

**D** | **PB5022STB**  
Stone Black



**A** | **KW5221PN-WG**  
Polished Nickel | White Glass

**A** | **KW5221AB-WG**  
Antique-Burnished Brass | White Glass

**A** | **KW5221BZ-WG**  
Bronze | White Glass

**A** | **PRECISION SMALL PENDANT**  
KELLY WEARSTLER

**KW5221**  
H: 51" | Fixture: 12" H | W: 10"  
Canopy: 4.5" Round  
Socket: E26 Keyless | Bulb: 60 A  
\* Custom Height Available (20" Minimum)

**B** | **PRECISION LARGE PENDANT**  
KELLY WEARSTLER

**KW5223**  
H: 58" | Fixture: 19" H | W: 17"  
Canopy: 4.5" Round  
Socket: E26 Keyless | Bulb: 60 A  
\* Custom Height Available (27" Minimum)



**B** | **KW5223PN-WG**  
Polished Nickel | White Glass

**B** | **KW5223AB-WG**  
Antique-Burnished Brass | White Glass

**B** | **KW5223BZ-WG**  
Bronze | White Glass

opposite page

**C** | **PRECISION SMALL CYLINDER PENDANT**  
KELLY WEARSTLER

**KW5224**  
O/A H: 51" | Fixture: 15.5" H | W: 4.5"  
Canopy: 4.5" Round  
Socket: E26 Keyless | Bulb: 40 T  
**Additional Options:**  
Bronze | White Glass (BZ-WG)  
\* Custom Height Available (20.75" Minimum)



**B** | **KW5223AB-WG**  
Antique-Burnished Brass | White Glass

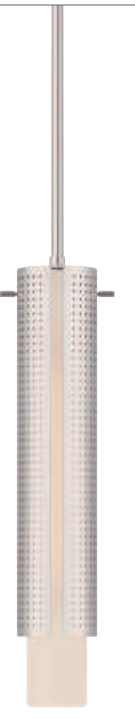

**C** | **KW5224PN-WG**  
Polished Nickel | White Glass

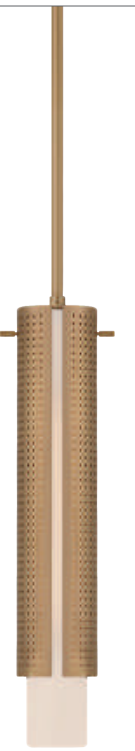

**C** | **KW5224AB-WG**  
Antique-Burnished Brass | White Glass



A TOB5062BZ/HAB-WG  
Bronze | Brass | White Glass

**A HICKS SMALL PENDANT**  
THOMAS O'BRIEN

**TOB5062**  
H: 11.75" | W: 8.5" | Canopy: 4.75" Round  
Socket: E26 Keyless | Bulb: 75 A  
**Additional Options:**  
Hand-Rubbed Antique Brass | White Glass (HAB-WG)

**B HICKS LARGE PENDANT**  
THOMAS O'BRIEN

**TOB5063**  
H: 18" | W: 13.25" | Canopy: 4.75" Round  
Socket: 2 - E26 Keyless | Bulb: 2 - 75 A  
**Additional Options:**  
Antique Nickel | White Glass (AN-WG)  
Polished Nickel | White Glass (PN-WG)

**C HICKS EXTRA LARGE PENDANT**  
THOMAS O'BRIEN

**TOB5064**  
H: 22" | W: 16" | Canopy: 4.75" Round  
Socket: 2 - E26 Keyless | Bulb: 2 - 75 A



A TOB5062PN-WG  
Polished Nickel | White Glass

A TOB5062AN-WG  
Antique Nickel | White Glass

B TOB5063HAB-WG  
Hand-Rubbed Antique Brass | White Glass

B TOB5063BZ/HAB-WG  
Bronze | Brass | White Glass



C TOB5064PN-WG  
Polished Nickel | White Glass

C TOB5064AN-WG  
Antique Nickel | White Glass

C TOB5064HAB-WG  
Hand-Rubbed Antique Brass | White Glass

C TOB5064BZ/HAB-WG  
Bronze | Brass | White Glass



**A HICKS SMALL PENDANT**  
THOMAS O'BRIEN  
**TOB5068**  
H: 9.25" | W: 8.75" | Canopy: 4.75" Round  
Socket: 2 - E26 Keyless | Bulb: 2 - 60 A

**B HICKS LARGE PENDANT**  
THOMAS O'BRIEN  
**TOB5069**  
H: 11.75" | W: 13" | Canopy: 4.5" Round  
Socket: 2 - E26 Keyless | Bulb: 2 - 60 A

**C HICKS EXTRA LARGE PENDANT**  
THOMAS O'BRIEN  
**TOB5071**  
H: 13.75" | W: 16" | Canopy: 4.5" Round  
Socket: 2 - E26 Keyless | Bulb: 2 - 60 A

**Additional Options for Hicks:**  
Antique Nickel | Acrylic (AN)  
Bronze | Brass | Acrylic (BZ/HAB/FA)  
Hand-Rubbed Antique Brass | Acrylic (HAB)  
Polished Nickel | Acrylic (PN)

**A TOB5068PN** Polished Nickel | Acrylic  
**A TOB5068AN** Antique Nickel | Acrylic  
**B TOB5069HAB** Hand-Rubbed Antique Brass | Acrylic  
**B TOB5069BZ/HAB** Bronze | Hand-Rubbed Antique Brass | Acrylic



**D ANDERS SMALL CYLINDRICAL PENDANT**  
THOMAS O'BRIEN  
**TOB5097**  
H: 50" | Fixture: 10.5" H | W: 3.75"  
Canopy: 5.25" Round  
Socket: E17 Keyless | Bulb: 40 R14  
\* Custom Height Available (18" Minimum)

**E ANDERS MEDIUM CYLINDRICAL PENDANT**  
THOMAS O'BRIEN  
**TOB5098**  
H: 56.75" | Fixture: 16" H | W: 4.5"  
Canopy: 5.25" Round  
Socket: E26 Keyless | Bulb: 40 R20  
\* Custom Height Available (26" Minimum)

**F ANDERS LARGE CYLINDRICAL PENDANT**  
THOMAS O'BRIEN  
**TOB5099**  
H: 60.25" | Fixture: 19.5" H | W: 6"  
Canopy: 5.25" Round  
Socket: E26 Keyless | Bulb: 60 R30  
\* Custom Height Available (31" Minimum)

**Additional Options for Anders:**  
Antique Nickel (AN)  
Antique Nickel | Bronze (AN/BZ)  
Hand-Rubbed Antique Brass (HAB)  
Hand-Rubbed Antique Brass | Black (HAB/BLK)  
Hand-Rubbed Antique Brass | White (HAB/WHT)  
Polished Nickel (PN)

**C TOB5071PN** Polished Nickel | Acrylic  
**C TOB5071AN** Antique Nickel | Acrylic  
**C TOB5071HAB** Hand-Rubbed Antique Brass | Acrylic  
**C TOB5071BZ/HAB** Bronze | Hand-Rubbed Antique Brass | Acrylic



**D TOB5097PN** Polished Nickel  
**D TOB5097AN** Antique Nickel  
**E TOB5098AN/BZ** Antique Nickel | Bronze



**F TOB5099HAB/WHT** Hand-Rubbed Antique Brass | White  
**F TOB5099HAB** Hand-Rubbed Antique Brass  
**F TOB5099HAB/BLK** Hand-Rubbed Antique Brass | Black



**A** | **KW5415PN-FG**  
Polished Nickel | Frosted Glass

**A** | **KW5415AB-FG**  
Antique-Burnished Brass | Frosted Glass

**A** | **KW5415BZ/AB-FG**  
Bronze | Antique-Burnished Brass | Frosted Glass

**A** | **LARCHMONT LONG PENDANT**  
KELLY WEARSTLER  
  
**KW5415**  
H: 43" | W: 8.75" | Canopy: 4.5" Round  
Socket: E12 Candelabra | Bulb: 60 B



**B** | **KW5570PN-WG**  
Polished Nickel | White Glass

**B** | **KW5570AB-WG**  
Antique-Burnished Brass | White Glass

**B** | **KW5570BZ/AB-WG**  
Bronze | Antique-Burnished Brass | White Glass

**B** | **NOUVEL SMALL PENDANT**  
KELLY WEARSTLER  
  
**KW5570**  
H: 61.25" | Fixture: 26" H | W: 13.25"  
Canopy: 6.25" Round | LED: 44w  
\* Custom Height Available (28.5" Minimum)



**B** | **KW5570BZ/AB-WG**  
Bronze | Antique-Burnished Brass | White Glass

**C** | **KW5192AB/Q**  
Antique-Burnished Brass | Quartz



**C** | **HALCYON SMALL PENDANT**  
KELLY WEARSTLER  
  
**KW5192**  
H: 46.5" | Fixture: 13" H | W: 4"  
Canopy: 5.25" Round  
LED: 12w  
\* Custom Height Available (20" Minimum)







**A** | **KW5610PN-ALB**  
Polished Nickel | Alabaster

**A** | **KW5610AB-ALB**  
Antique-Burnished Brass | Alabaster

**B** | **KW5111PN-ALB**  
Polished Nickel | Alabaster

**B** | **KW5111AB-ALB**  
Antique-Burnished Brass | Alabaster



**C** | **KW5612AB-ALB**  
Antique-Burnished Brass | Alabaster

**C** | **KW5612BZ-ALB**  
Bronze | Alabaster

**D** | **KW5512AB-ALB**  
Antique-Burnished Brass | Alabaster

**D** | **KW5512BZ-ALB**  
Bronze | Alabaster

**A** | **MELANGE SMALL FLOATING DISC PENDANT**  
KELLY WEARSTLER

**KW5610**  
H: 52.75" | Fixture: 18" H | W: 5"  
Canopy: 4.5" Round | LED: 4w  
**Additional Options:**  
Bronze | Alabaster (BZ-ALB)  
\* Custom Height Available (20.25" Minimum)

**B** | **COVET TALL SINGLE PENDANT**  
KELLY WEARSTLER

**KW5111**  
H: 53.5" | Fixture: 18.75" H | W: 4.5"  
Canopy: 4.5" Square  
Socket: E26 Keyless | Bulb: 16w LED  
**Additional Options:**  
Bronze | Alabaster (BZ-ALB)  
\* Custom Height Available (20.75" Minimum)  
\* Bulb Included

**C** | **MELANGE MEDIUM FLOATING DISC PENDANT**  
KELLY WEARSTLER

**KW5612**  
H: 64.75" | Fixture: 30" H | W: 10.25"  
Canopy: 7" Round | LED: 9w  
**Additional Options:**  
Polished Nickel | Alabaster (PN-ALB)  
\* Custom Height Available (32.25" Minimum)

**D** | **MELANGE SMALL ELONGATED PENDANT**  
KELLY WEARSTLER

**KW5512**  
H: 29" | W: 6.25" | Canopy: 6" Round  
Socket: E26 Keyless | Bulb: 9w LED T  
**Additional Options:**  
Polished Nickel | Alabaster (PN-ALB)

**E** | **ROUSSEAU SINGLE PENDANT**  
KELLY WEARSTLER

**KW5586**  
H: 60.5" | Fixture: 22.75" H | W: 4.5"  
Canopy: 4.5" Round | LED: 5w  
**Additional Options:**  
Antique-Burnished Brass | Etched Crystal (AB-EC)  
Bronze | Etched Crystal (BZ-EC)  
Polished Nickel | Etched Crystal (PN-EC)  
\* Custom Height Available (28.75" Minimum)

**F** | **ROUSSEAU SMALL ASYMMETRIC CHANDELIER**  
KELLY WEARSTLER

**KW5590**  
H: 62.5" | Fixture: 25.25" H | W: 8.25"  
Canopy: 4.5" Round | LED: 8w  
**Additional Options:**  
Antique-Burnished Brass | Seeded Glass (AB-SG)  
Bronze | Seeded Glass (BZ-SG)  
Polished Nickel | Seeded Glass (PN-SG)  
\* Custom Height Available (30.5" Minimum)



**E** | **KW5586PN-SG**  
Polished Nickel | Seeded Glass

**E** | **KW5586AB-SG**  
Antique-Burnished Brass | Seeded Glass

**E** | **KW5586BZ-SG**  
Bronze | Seeded Glass



**F** | **KW5590PN-EC**  
Polished Nickel | Etched Crystal

**F** | **KW5590AB-EC**  
Antique-Burnished Brass | Etched Crystal

**F** | **KW5590BZ-EC**  
Bronze | Etched Crystal



**A FASCIO MEDIUM PENDANT**  
LAUREN ROTTET  
  
**LR5905**  
H: 55.75" | Fixture: 25.25" H | W: 6.75"  
Canopy: 7" x 8" Hex. | LED: 74w  
\* Custom Height Available (27.25" Minimum)

**B AMBAR SMALL PENDANT**  
IAN K. FOWLER  
  
**S5944**  
O/A H: 49" | Fixture: 9.5" H | W: 2.5"  
Canopy: 4.5" Square  
Socket: E12 Candelabra | Bulb: 40 T  
\* Custom Height Available (13.7" Minimum)

**C LIAISON SMALL PENDANT**  
KELLY WEARSTLER  
  
**KW5118**  
H: 53" | Fixture: 18.75" H | W: 4"  
Canopy: 4" Round  
Socket: E26 Keyless | Bulb: 40 T  
\* Custom Height Available (23" Minimum)

**A LR5905PN-CG**  
Polished Nickel | Crystal

**A LR5905HAB-CG**  
Hand-Rubbed Antique Brass | Crystal

**A LR5905BZ-CG**  
Bronze | Crystal



**B S5944PN-CG**  
Polished Nickel | Crystal

**B S5944HAB-CG**  
Hand-Rubbed Antique Brass | Crystal

**C KW5118PN-CRG**  
Polished Nickel | Crackle Glass

**C KW5118BZ-CRG**  
Bronze | Crackle Glass

**C KW5118AB-CRG**  
Antique-Burnished Brass | Crackle Glass





**A** | **KS5300PN-CG**  
Polished Nickel | Crystal

**A** | **KS5300SB-CG**  
Soft Brass | Crystal

**B** | **KW5270PN-CG**  
Polished Nickel | Clear Glass

**B** | **KW5270AB-CG**  
Antique-Burnished Brass | Clear Glass

**E** | **KW5277PN-CG**  
Polished Nickel | Clear Glass

**E** | **KW5277AB-CG**  
Antique-Burnished Brass | Clear Glass

**E** | **KW5277BZ-CG**  
Bronze | Clear Glass



**C** | **KS5305PN-CG**  
Polished Nickel | Crystal

**C** | **KS5305SB-CG**  
Soft Brass | Crystal

**D** | **KW5275PN-CG**  
Polished Nickel | Clear Glass

**D** | **KW5275AB-CG**  
Antique-Burnished Brass | Clear Glass

**E** | **KW5277PN-VG**  
Polished Nickel | Volcanic Glass

**E** | **KW5277AB-VG**  
Antique-Burnished Brass | Volcanic Glass

**E** | **KW5277BZ-VG**  
Bronze | Volcanic Glass

opposite page

**A** | **DARCY SMALL PENDANT**  
KATE SPADE NEW YORK

**KS5300**  
H: 46" | Fixture: 11.75" H | W: 6"  
Canopy: 4.5" Round  
Socket: E12 Candelabra | Bulb: 60 B  
\* Custom Height Available (15.5" Minimum)

**B** | **TABLEAU SMALL PENDANT**  
KELLY WEARSTLER

**KW5270**  
H: 52" | Fixture: 15.5" H | W: 6.75"  
Canopy: 4" Round  
Socket: E26 Keyless | Bulb: 40 T  
**Additional Options:**  
Antique-Burnished Brass | Volcanic Glass (AB-VG)  
Bronze | Clear Glass (BZ-CG)  
Bronze | Volcanic Glass (BZ-VG)  
Polished Nickel | Volcanic Glass (PN-VG)  
\* Custom Height Available (27" Minimum)

**C** | **DARCY MEDIUM PENDANT**  
KATE SPADE NEW YORK

**KS5305**  
H: 48" | Fixture: 13.75" H | W: 11.75"  
Canopy: 4.5" Round  
Socket: E12 Candelabra | Bulb: 60 B  
\* Custom Height Available (17" Minimum)

**D** | **TABLEAU MEDIUM PENDANT**  
KELLY WEARSTLER

**KW5275**  
H: 53" | Fixture: 16.5" H | W: 12.25"  
Canopy: 5" Round  
Socket: E26 Keyless | Bulb: 60 T  
**Additional Options:**  
Antique-Burnished Brass | Volcanic Glass (AB-VG)  
Bronze | Clear Glass (BZ-CG)  
Bronze | Volcanic Glass (BZ-VG)  
Polished Nickel | Volcanic Glass (PN-VG)  
\* Custom Height Available (29" Minimum)

**E** | **TABLEAU LARGE PENDANT**  
KELLY WEARSTLER

**KW5277**  
O/A H: 60" | Fixture: 24" H | W: 18"  
Canopy: 5" Round  
Socket: E26 Keyless | Bulb: 60 T  
\* Custom Height Available (34.5" Minimum)



**A** **LUCIA SMALL PENDANT**  
JULIE NEILL  
  
**JN5050**  
H: 12.5" | W: 8.5" | Canopy: 5" Round  
Socket: E26 Keyless | Bulb: 60 A

**B** **LUCIA MEDIUM PENDANT**  
JULIE NEILL  
  
**JN5051**  
H: 17.5" | W: 13.5" | Canopy: 5" Round  
Socket: E26 Keyless | Bulb: 60 A

**C** **LUCIA LARGE PENDANT**  
JULIE NEILL  
  
**JN5052**  
H: 24" | W: 13" | Canopy: 5" Round  
Socket: 4 - E12 Candelabra | Bulb: 4 - 40 C

**Additional Options for Lucia:**  
Celadon | Gild | Clear Glass (CEL/G-CG)  
Gild | White | Clear Glass (G/WHT-CG)  
Matte Black | Gild | Clear Glass (MBK/G-CG)  
Matte White | Gild | Clear Glass (WHT/G-CG)

**A** **JN5050WHT/G-CG**  
Matte White | Gild | Clear Glass

**B** **JN5051CEL/G-CG**  
Celadon | Gild Clear Glass

**B** **JN5051MBK/G-CG**  
Matte Black | Gild | Clear Glass



**C** **JN5052WHT/G-CG**  
Matte White | Gild | Clear Glass

**C** **JN5052CEL/G-CG**  
Celadon | Gild | Clear Glass

**C** **JN5052MBK/G-CG**  
Matte Black | Gild | Clear Glass

opposite page

**D** **TURENNE MEDIUM GLOBE PENDANT**  
AERIN

**ARN5255**  
Fixture: 16.5" H | W: 14" | Canopy: 5" Round  
Socket: 4 - E12 Candelabra | Bulb: 4 - 40 B



**D** **ARN5255PN-CG**  
Polished Nickel | Clear Glass



**D** **ARN5255PN-CG**  
Polished Nickel | Clear Glass



**D** **ARN5255HAB-CG**  
Hand-Rubbed Antique Brass | Clear Glass



**A** | **AH5015PN-FG**  
Polished Nickel | Frosted Glass



**A** | **AH5015GM-FG**  
Gun Metal | Frosted Glass



**A** | **AH5015NB-FG**  
Natural Brass | Frosted Glass



**B** | **TOB5160PN-WG**  
Polished Nickel | White Glass



**B** | **TOB5160HAB-WG**  
Hand-Rubbed Antique Brass | White Glass

opposite page

**A** | **HAILEY MEDIUM ROUND PENDANT**  
ALEXA HAMPTON

**AH5015**  
H: 35" - 87" | W: 18" | Canopy: 4.375" Round  
Socket: E26 Keyless | Bulb: 75 A  
\* Custom Height Available (35" Minimum)

**B** | **EDEN MEDIUM PENDANT**  
THOMAS O'BRIEN

**TOB5160**  
H: 36.5" | Fixture: 21" H | W: 9"  
Canopy: 4.75" Round  
Socket: 3 - E26 Keyless | Bulb: 3 - 60 A  
\* Custom Height Available (26" Minimum)

**C** | **MILTON ROAD FLUSH MOUNT**  
THOMAS O'BRIEN

**TOB5150**  
H: 14" | W: 14.25" | Canopy: 5.75" Round  
Socket: E26 Keyless | Bulb: 75 A  
\* Includes Installation Hardware for  
Flush Mount and Pendant



**C** | **TOB5150PN-WG**  
Polished Nickel | White Glass



**C** | **TOB5150HAB-WG**  
Hand-Rubbed Antique Brass | White Glass



**C** | **TOB5150AN-WG**  
Antique Nickel | White Glass



**C** | **TOB5150BZ-WG**  
Bronze | White Glass



**A** AH5210PN  
Polished Nickel

**A** AH5210NB  
Natural Brass

**A** AH5210GM  
Gun Metal

**A LILY SMALL PENDANT**  
ALEXA HAMPTON

**AH5210**  
H: 46" | W: 15" | Canopy: 4.25" Round  
Socket: 3 - E12 Candelabra | Bulb: 3 - 60 C  
Shade: 9" x 15" x 12"  
\* Custom Height Available (25" Minimum)

**B BRYDEN MEDIUM ROUND PENDANT**  
E. F. CHAPMAN

**CHC5095**  
H: 55" | Fixture: 13" H | W: 18"  
Canopy: 5.5" Round  
Socket: 2 - E26 Keyless | Bulb: 2 - 60 A  
\* Custom Height Available (24" Minimum)  
©EFC DESIGNS



**B** CHC5095PN  
Polished Nickel | White Acrylic

**B** CHC5095GI  
Gilded Iron | White Acrylic

**B** CHC5095AI  
Aged Iron | White Acrylic

opposite page

**C WHITMAN MEDIUM PENDANT**  
THOMAS O'BRIEN

**TOB5112**  
O/A H: 53" | Fixture: 16.5" H | W: 19.25"  
Canopy: 5.25" Round  
Socket: E26 Keyless | Bulb: 75 A  
**Additional Options:**  
Hand-Rubbed Antique Brass (HAB-HAB)  
Polished Nickel (PN-PN)  
\* Custom Height Available (24" Minimum)

**D WHITMAN LARGE PENDANT**  
THOMAS O'BRIEN

**TOB5113**  
H: 56" | Fixture: 21.75" H | W: 28.25"  
Canopy: 5.25" Round  
Socket: E26 Keyless | Bulb: 75 A  
**Additional Options:**  
Hand-Rubbed Antique Brass | White Glass (HAB-WG)  
Polished Nickel | White Glass (PN-WG)  
\* Custom Height Available (30" Minimum)



**C** TOB5112PN-WG  
Polished Nickel | White Glass

**C** TOB5112HAB-WG  
Hand-Rubbed Antique Brass | White Glass

**C** TOB5112BZ/HAB-BZ  
Bronze | Brass



**D** TOB5113PN-PN  
Polished Nickel

**D** TOB5113HAB-HAB  
Hand-Rubbed Antique Brass

**D** TOB5113BZ/HAB-BZ  
Bronze | Brass



**A** TOB5012AW  
Antique White

**A** TOB5012AN  
Antique Nickel

**B** TOB5013HAB  
Hand-Rubbed Antique Brass

**B** TOB5013BZ  
Bronze



**C** TOB5000AW  
Antique White

**C** TOB5000AN  
Antique Nickel

**C** TOB5000HAB  
Hand-Rubbed Antique Brass

**C** TOB5000BZ  
Bronze



**C** TOB5000HAB  
Hand-Rubbed Antique Brass

**A** EUGENE SMALL PENDANT  
THOMAS O'BRIEN

**TOB5012**  
O/A H: 159" | Fixture: 12" H | W: 12"  
Canopy: 3.5" Round  
Socket: E26 Keyless | Bulb: 150 A  
**Additional Options:**  
Bronze (BZ)  
Hand-Rubbed Antique Brass (HAB)  
\* Requires Smaller Outlet Box  
\* Custom Height Available (17" Minimum)

**B** EUGENE MEDIUM PENDANT  
THOMAS O'BRIEN

**TOB5013**  
O/A H: 162" | Fixture: 15" H | W: 15.5"  
Canopy: 3.5" Round  
Socket: E26 Keyless | Bulb: 150 A  
**Additional Options:**  
Antique Nickel (AN)  
Antique White (AW)  
\* Requires Smaller Outlet Box  
\* Custom Height Available (20" Minimum)

**C** EUGENE LARGE PENDANT  
THOMAS O'BRIEN

**TOB5000**  
H: 156" | Fixture: 19" H | W: 21"  
Canopy: 3.5" Round  
Socket: E26 Keyless | Bulb: 150 A  
\* Requires Smaller Outlet Box  
\* Custom Height Available (24" Minimum)



**A** | **CHC5133PN-WG**  
Polished Nickel | White Glass

**A** | **CHC5133AN-AN**  
Antique Nickel

**A** | **CHC5133AB-WG**  
Antique-Burnished Brass | White Glass

**A** | **CHC5133BZ-BZ**  
Bronze



**B** | **CHC5136PN-PN**  
Polished Nickel

**B** | **CHC5136AN-WG**  
Antique Nickel | White Glass

**B** | **CHC5136AB-AB**  
Antique-Burnished Brass

**B** | **CHC5136BZ-WG**  
Bronze | White Glass



**B** | **CHC5136BZ-BZ**  
Bronze

**A** | **COUNTRY INDUSTRIAL SMALL PENDANT**  
E. F. CHAPMAN

**CHC5133**  
H: 59" | W: 14" | Canopy: 5.5" Round  
Socket: E26 Keyless | Bulb: 100 A  
Shade: 9.5" x 14"

**Additional Options:**  
Antique-Burnished Brass | Brass (AB-AB)  
Antique Nickel | White Glass (AN-WG)  
Bronze | White Glass (BZ-WG)  
Polished Nickel | Polished Nickel (PN-PN)  
\* Custom Height Available (28" Minimum)  
©EFC DESIGNS

**B** | **COUNTRY INDUSTRIAL LARGE PENDANT**  
E. F. CHAPMAN

**CHC5136**  
H: 59" | W: 19.5" | Canopy: 5.5" Round  
Socket: E26 Keyless | Bulb: 100 A  
Shade: 9.5" x 19.5"

**Additional Options:**  
Antique-Burnished Brass | White Glass (AB-WG)  
Antique Nickel | Antique Nickel (AN-AN)  
Polished Nickel | White Glass (PN-WG)  
\* Custom Height Available (28" Minimum)  
©EFC DESIGNS







**A** | **SL5175PN-PN2** Polished Nickel      **A** | **SL5175AN-AN2** Antique Nickel      **A** | **SL5175HAB-HAB2** Hand-Rubbed Antique Brass      **A** | **SL5175BZ-BZ2** Bronze

opposite page

**A** **YOKE SMALL PENDANT**  
E. F. CHAPMAN

**SL5175**  
H: 55.75" | W: 11" | Canopy: 5.5" Round  
Socket: E26 Keyless | Bulb: 150 A  
\* Custom Height Available (24" Minimum)  
©EFC DESIGNS

**B** **YOKE LARGE PENDANT**  
E. F. CHAPMAN

**SL5175**  
H: 55.75" | W: 17.5" | Canopy: 5.5" Round  
Socket: E26 Keyless | Bulb: 150 A  
\* Custom Height Available (24" Minimum)  
©EFC DESIGNS



**C** | **SL5174PN-PN** Polished Nickel      **C** | **SL5174AN-AN** Antique Nickel      **C** | **SL5174HAB-HAB** Hand-Rubbed Antique Brass      **C** | **SL5174BZ-BZ** Bronze



**B** | **SL5175PN-PN1** Polished Nickel      **B** | **SL5175AN-AN1** Antique Nickel      **B** | **SL5175HAB-HAB1** Hand-Rubbed Antique Brass      **B** | **SL5175BZ-BZ1** Bronze

**C** **YOKE MINI PENDANT**  
E. F. CHAPMAN

**SL5174**  
H: 47" | W: 5.5" | Canopy: 4.5" Round  
Socket: E26 Keyless | Bulb: 60 A  
\* Custom Height Available (18" Minimum)  
©EFC DESIGNS



**C** | **SL5174PN-WG** Polished Nickel | White Glass      **C** | **SL5174AN-WG** Antique Nickel | White Glass      **C** | **SL5174HAB-WG** Hand-Rubbed Antique Brass | White Glass      **C** | **SL5174BZ-WG** Bronze | White Glass



A | **CHC5101AN-AN**  
Antique Nickel



A | **CHC5101BZ-BZ**  
Bronze



A | **CHC5101AB-AB**  
Antique-Burnished Brass

opposite page

**A SLOANE SINGLE SHOP PENDANT**  
E. F. CHAPMAN

**CHC5101**  
O/A H: 47.25" | W: 15.5" | Canopy: 5.75" Round  
Socket: 2 - E26 Keyless | Bulb: 2 - 60 A  
Shade: 11.5" x 15.5" x 10"  
**Additional Options:**  
Antique-Burnished Brass | Linen (AB-L)  
Antique Nickel | Linen (AN-L)  
Bronze | Linen (BZ-L)  
\* Custom Height Available (21" Minimum)  
©EFC DESIGNS



B | **CHC5132PN-PN**  
Polished Nickel | White Acrylic

B | **CHC5132AN-AN**  
Antique Nickel | White Acrylic

B | **CHC5132AB-AB**  
Antique-Burnished Brass | White Acrylic

B | **CHC5132BZ-BZ**  
Bronze | White Acrylic



B | **CHC5132PN-CG**  
Polished Nickel | Clear Glass

B | **CHC5132AN-WG**  
Antique Nickel | White Glass

B | **CHC5132AB-WG**  
Antique-Burnished Brass | White Glass

B | **CHC5132BZ-WG**  
Bronze | White Glass

**B SLOANE SINGLE PENDANT**  
E. F. CHAPMAN

**CHC5132**  
H: 44" | W: 10" | Canopy: 5.5" Round  
Socket: E26 Keyless | Bulb: 100 A  
**Additional Options:**  
Antique-Burnished Brass | Clear Glass (AB-CG)  
Antique Nickel | Clear Glass (AN-CG)  
Bronze | Clear Glass (BZ-CG)  
Polished Nickel | White Glass (PN-WG)  
\* Custom Height Available (21" Minimum)  
©EFC DESIGNS



**A** | **SL5125PN/SLD-PN**  
Polished Nickel | Mini Slant

**A** | **SL5125AN/SLD-AN**  
Antique Nickel | Mini Slant

**A** | **SL5125HAB/SLD-HAB**  
Hand-Rubbed Antique Brass | Mini Slant

**A** | **SL5125BZ/SLD-BZ**  
Bronze | Mini Slant



**B** | **SL5125PN-WG1**  
Polished Nickel | White Glass Slant

**B** | **SL5125AN-CG1**  
Antique Nickel | Clear Glass Slant

**B** | **SL5125HAB-WG1**  
Hand-Rubbed Antique Brass | White Glass Slant

**B** | **SL5125BZ-CG1**  
Bronze | Clear Glass Slant



**A** | **BOSTON PENDANT**  
E. F. CHAPMAN

**SL5125**  
O/A H: 42" | W: 7.25" | Canopy: 4.5" Round  
Socket: E26 Keyless | Bulb: 100 A  
\* Custom Height Available (14" Minimum)  
©EFC DESIGNS

**B** | **BOSTON PENDANT**  
E. F. CHAPMAN

**SL5125**  
O/A H: 42" | W: 10" | Canopy: 4.5" Round  
Socket: E26 Keyless | Bulb: 100 A  
\* Custom Height Available (14" Minimum)  
©EFC DESIGNS

**Additional Options for Boston:**

- Antique Nickel (AN)
- Bronze (BZ)
- Hand-Rubbed Antique Brass (HAB)
- Polished Nickel (PN)
- Clear Glass Slant (CG1)
- White Glass Slant (WG1)
- Small White Dish Glass (WG2)
- Large White Dish Glass (WG3)
- Small Vintage Mercury Dish Glass (MG2)
- Large Vintage Mercury Dish Glass (MG3)
- SLEG (SLEG)

**B** | **SL5125BZ-WG1**  
Bronze | White Glass Slant



**A** | **TOB5076PN-CG**  
Polished Nickel | Prismatic Glass



**A** | **TOB5076AI-CG**  
Aged Iron | Prismatic Glass



**B** | **TOB5042HAB-WHT**  
Hand-Rubbed Antique Brass | White | Prismatic Glass



**B** | **TOB5042HAB-G**  
Hand-Rubbed Antique Brass | Green | Prismatic Glass

opposite page

**A** | **HARRIS MEDIUM FRAMED PENDANT**  
THOMAS O'BRIEN

**TOB5076**  
H: 49" | Fixture: 25.25" H | W: 17"  
Canopy: 7" Round  
Socket: E26 Keyless | Bulb: 75 A  
\* Custom Height Available (41" Minimum)



**B** | **TOB5042PN-WHT**  
Polished Nickel | White | Prismatic Glass



**B** | **TOB5042HAB-WHT**  
Hand-Rubbed Antique Brass | White | Prismatic Glass



**B** | **TOB5042HAB-G**  
Hand-Rubbed Antique Brass | Green | Prismatic Glass

**B** | **HENRY INDUSTRIAL HANGING LIGHT**  
THOMAS O'BRIEN

**TOB5042**  
H: 54.5" | Fixture: 24" H | W: 18"  
Canopy: 5.25" Round  
Socket: 2 - E26 Keyless | Bulb: 2 - 75 A  
\* Custom Height Available (31" Minimum)



**A** | **TOB5154PN-SG**  
Polished Nickel | Seeded Glass



**A** | **TOB5154AN-WG**  
Antique Nickel | White Glass



**B** | **TOB5155HAB-SG**  
Hand-Rubbed Antique Brass | Seeded Glass



**B** | **TOB5155BZ-WG**  
Bronze | White Glass



**C** | **TOB5156PN-WG**  
Polished Nickel | White Glass



**C** | **TOB5156AN-SG**  
Antique Nickel | Seeded Glass



**C** | **TOB5156HAB-WG**  
Hand-Rubbed Antique Brass | White Glass



**C** | **TOB5156BZ-SG**  
Bronze | Seeded Glass

**A** | **GALE PETITE PENDANT**  
THOMAS O'BRIEN

**TOB5154**  
H: 38.5" | Fixture: 11" H | W: 7.5"  
Canopy: 5" Round  
Socket: E26 Keyless | Bulb: 60 A  
\* Slope Mount Included  
\* Custom Height Available (20" Minimum)

**B** | **GALE SMALL PENDANT**  
THOMAS O'BRIEN

**TOB5155**  
H: 45.75" | Fixture: 17.25" H | W: 11.25"  
Canopy: 5" Round  
Socket: E26 Keyless | Bulb: 75 A  
\* Slope Mount Included  
\* Custom Height Available (24" Minimum)

**C** | **GALE LARGE PENDANT**  
THOMAS O'BRIEN

**TOB5156**  
H: 51" | Fixture: 24" H | W: 15.5"  
Canopy: 5" Round  
Socket: E26 Keyless | Bulb: 75 A  
\* Slope Mount Included  
\* Custom Height Available (32" Minimum)

**Available Options for Gale:**  
Antique Nickel (AN)  
Bronze (BZ)  
Hand-Rubbed Antique Brass (HAB)  
Polished Nickel (PN)  
Seeded Glass (SG)  
White Glass (WG)



**A** | **TOB5154PN-SG**  
Polished Nickel | White Glass



**A** | **TOB5751PN-CG**  
Polished Nickel | Clear Glass

**A** | **TOB5751HAB-CG**  
Hand-Rubbed Antique Brass | Clear Glass

**A** | **TOB5751BZ-CG**  
Bronze | Clear Glass



**B** | **TOB5752PN-WG**  
Polished Nickel | White Glass

**B** | **TOB5752HAB-WG**  
Hand-Rubbed Antique Brass | White Glass

**B** | **TOB5752BZ-WG**  
Bronze | White Glass

**A** | **ROBINSON SMALL PENDANT**  
THOMAS O'BRIEN  
  
**TOB5751**  
H: 11.25" | W: 4.75" | Canopy: 4.5" Round  
Socket: E12 Candelabra | Bulb: 60 B

**B** | **ROBINSON MEDIUM PENDANT**  
THOMAS O'BRIEN  
  
**TOB5752**  
H: 15" | W: 7.5" | Canopy: 4.5" Round  
Socket: E26 Keyless | Bulb: 75 A

**C** | **ROBINSON LARGE PENDANT**  
THOMAS O'BRIEN  
  
**TOB5753**  
H: 19.5" | W: 11.75" | Canopy: 4.5" Round  
Socket: E26 Keyless | Bulb: 75 A

**Available Options for Robinson:**  
Bronze (BZ)  
Hand-Rubbed Antique Brass (HAB)  
Polished Nickel (PN)  
Clear Glass (CG)  
Seeded Glass (SG)  
White Glass (WG)



**C** | **TOB5753HAB-SG**  
Hand-Rubbed Antique Brass | Seeded Glass



**C** | **TOB5753PN-SG**  
Polished Nickel | Seeded Glass



**C** | **TOB5753BZ-SG**  
Bronze | Seeded Glass



**A** **TOB5431PN-CG**  
Polished Nickel | Clear Glass

**A** **TOB5431HAB-CG**  
Hand-Rubbed Antique Brass | Clear Glass

**B** **TOB5432HAB-CG**  
Hand-Rubbed Antique Brass | Clear Glass

**B** **TOB5432BZ/HAB-CG**  
Bronze | Hand-Rubbed Antique Brass | Clear Glass



**C** **TOB5433PN-CG**  
Polished Nickel | Clear Glass

**C** **TOB5433HAB-CG**  
Hand-Rubbed Antique Brass | Clear Glass

**C** **TOB5433BZ/HAB-CG**  
Bronze | Hand-Rubbed Antique Brass | Clear Glass

opposite page

**A** **GABLE LARGE DOME PENDANT**  
THOMAS O'BRIEN

**TOB5431**  
H: 53.5" | Fixture: 18" H | W: 21.5"  
Canopy: 5.5" Round  
Socket: E26 Keyless | Bulb: 75 A  
**Available Options:**  
Hand-Rubbed Antique Brass | Clear Glass (HAB-CG)  
\* Custom Height Available (23" Minimum)

**B** **GABLE MEDIUM BELL PENDANT**  
THOMAS O'BRIEN

**TOB5432**  
H: 57.5" | Fixture: 22.25" H | W: 15"  
Canopy: 5.5" Round  
Socket: E26 Keyless | Bulb: 75 A  
**Available Options:**  
Polished Nickel | Clear Glass (PN-CG)

**C** **GABLE LARGE CONICAL PENDANT**  
THOMAS O'BRIEN

**TOB5433**  
H: 52.5" | Fixture: 17" H | W: 26"  
Canopy: 5.5" Round  
Socket: E26 Keyless | Bulb: 75 A

**D** **GABLE LARGE GLOBE PENDANT**  
THOMAS O'BRIEN

**TOB5430**  
H: 57" | Fixture: 21.5" H | W: 15"  
Canopy: 5.5" Round  
Socket: E26 Keyless | Bulb: 75 A  
**Available Options:**  
Hand-Rubbed Antique Brass | Clear Glass (HAB-CG)  
Polished Nickel | Clear Glass (PN-CG)  
\* Custom Height Available (26.75" Minimum)



**D** **TOB5430BZ/HAB-CG**  
Bronze | Hand-Rubbed Antique Brass | Clear Glass



**A** | **TOB5226BZ/G2-CG**  
Bronze | Clear Glass

**A** | **KATIE ACORN PENDANT**  
THOMAS O'BRIEN

**TOB52262**  
H: 13" | W: 10.5" | Canopy: 5.25" Round  
Socket: E26 Keyless | Bulb: 75 A  
\* Item Includes 3 ft. of Chain

**Available Options for Katie:**  
Bronze (BZ)  
Hand-Rubbed Antique Brass (HAB)  
Polished Nickel (PN)  
Clear Glass (CG)  
Seeded Glass (SG)  
White Glass (WG)

opposite page

**B** | **KATIE GLOBE PENDANT**  
THOMAS O'BRIEN

**TOB52264**  
H: 14" | W: 12" | Canopy: 5.25" Round  
Socket: E26 Keyless | Bulb: 75 A  
\* Item Includes 3 ft. of Chain

**C** | **KATIE DOME PENDANT**  
THOMAS O'BRIEN

**TOB52265**  
H: 10.75" | W: 12" | Canopy: 5.25" Round  
Socket: E26 Keyless | Bulb: 75 A  
\* Item Includes 3 ft. of Chain

**D** | **KATIE CONICAL PENDANT**  
THOMAS O'BRIEN

**TOB52266**  
H: 14.75" | W: 15.75" | Canopy: 5.25" Round  
Socket: E26 Keyless | Bulb: 75 A  
\* Item Includes 3 ft. of Chain

**E** | **KATIE CYLINDER PENDANT**  
THOMAS O'BRIEN

**TOB52263**  
H: 15.75" | W: 7" | Canopy: 5.25" Round  
Socket: E26 Keyless | Bulb: 75 A  
\* Item Includes 3 ft. of Chain

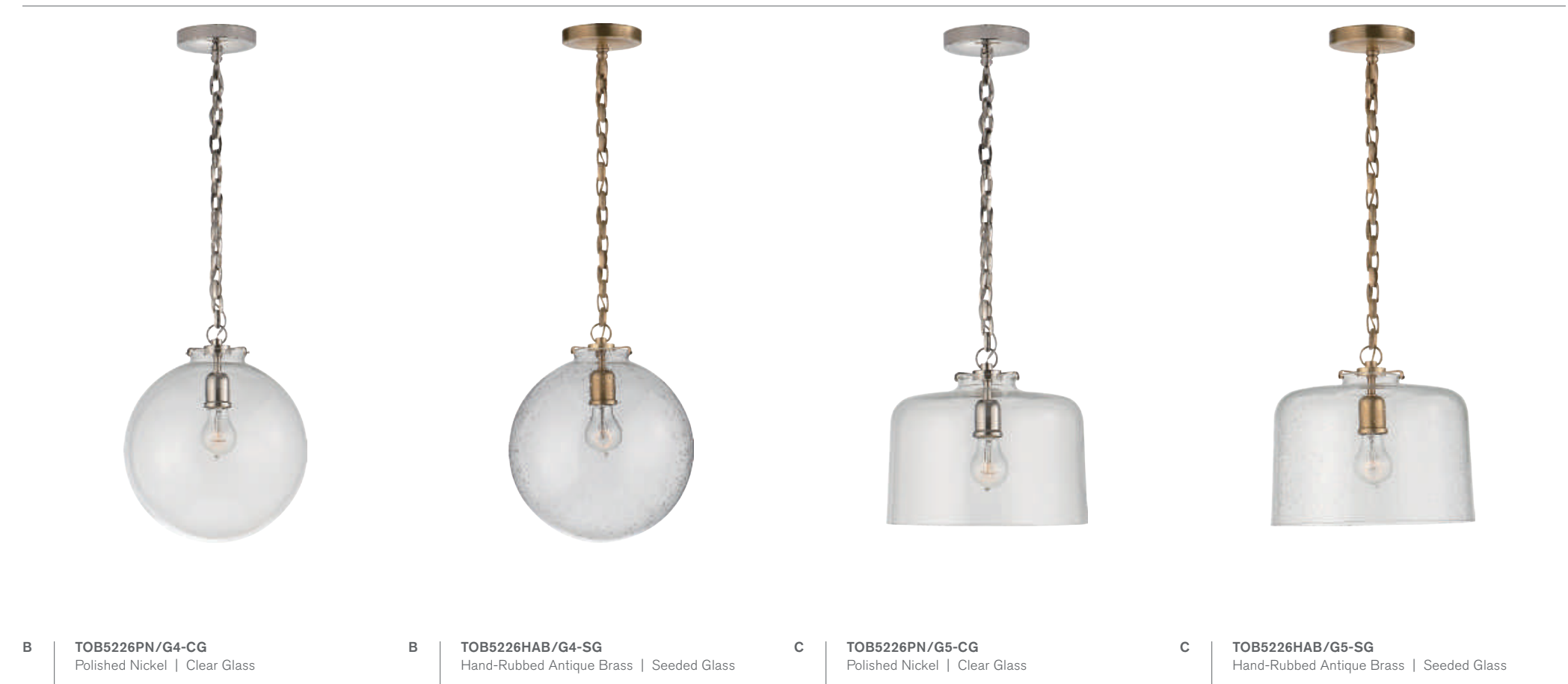

**B** | **TOB5226PN/G4-CG**  
Polished Nickel | Clear Glass

**B** | **TOB5226HAB/G4-SG**  
Hand-Rubbed Antique Brass | Seeded Glass

**C** | **TOB5226PN/G5-CG**  
Polished Nickel | Clear Glass

**C** | **TOB5226HAB/G5-SG**  
Hand-Rubbed Antique Brass | Seeded Glass



**D** | **TOB5226PN/G6-CG**  
Polished Nickel | Clear Glass

**D** | **TOB5226BZ/G6-WG**  
Bronze | White Glass

**E** | **TOB5226PN/G3-CG**  
Polished Nickel | Clear Glass

**E** | **TOB5226BZ/G3-WG**  
Bronze | White Glass



**A PRESIDIO PETITE PENDANT**  
IAN K. FOWLER

**S5672**  
O/A H: 47" | Fixture: 11.5" H | W: 4.25"  
Canopy: 4.75" Round  
Socket: E26 Keyless | Bulb: 60 T  
**Additional Options:**  
Bronze | Clear Glass (BZ-CG)  
Hand-Rubbed Antique Brass | Clear Glass (HAB-CG)  
\* Custom Height Available (18" Minimum)

**B PRESIDIO SMALL PENDANT**  
IAN K. FOWLER

**S5673**  
O/A H: 51.5" | Fixture: 15.75" H | W: 6.5"  
Canopy: 4.75" Round  
Socket: E26 Keyless | Bulb: 60 T  
**Additional Options:**  
Polished Nickel | Clear Glass (PN-CG)  
\* Custom Height Available (26" Minimum)

**C PRESIDIO MEDIUM PENDANT**  
IAN K. FOWLER

**S5674**  
O/A H: 59.5" | Fixture: 24.5" H | W: 12.5"  
Canopy: 4.75" Round  
Socket: 4 - E26 Keyless | Bulb: 4 - 40 T  
\* Custom Height Available (38" Minimum)



**A S5672PN-CG**  
Polished Nickel | Clear Glass

**B S5673HAB-CG**  
Hand-Rubbed Antique Brass | Clear Glass

**B S5673BZ-CG**  
Bronze | Clear Glass



**C S5674PN-CG**  
Polished Nickel | Clear Glass

**C S5674HAB-CG**  
Hand-Rubbed Antique Brass | Clear Glass

**C S5674BZ-CG**  
Bronze | Clear Glass

**D MARAIS PETITE PENDANT**  
THOMAS O'BRIEN

**TOB5305**  
H: 52" | Fixture: 14" H | W: 5" | Canopy: 6" Round  
Socket: E26 Keyless | Bulb: 60 A  
**Additional Options:**  
Bronze | Brass | White Glass (BZ/HAB-WG)  
Hand-Rubbed Antique Brass | White Glass (HAB-WG)  
Polished Nickel | Clear Glass (PN-CG)

**E IRIS SINGLE PENDANT**  
THOMAS O'BRIEN

**TOB5702**  
Fixture: 9.5" H | W: 7.5" | Canopy: 6" Square  
Socket: E26 Keyless | Bulb: 60 G  
\* Custom Height Available (15" Minimum)



**D TOB5305PN-WG**  
Polished Nickel | White Glass

**D TOB5305HAB-CG**  
Hand-Rubbed Antique Brass | Clear Glass

**D TOB5305BZ/HAB-CG**  
Bronze | Hand-Rubbed Antique Brass | Clear Glass



**E TOB5702PN-CG**  
Polished Nickel | Clear Glass

**E TOB5702HAB-CG**  
Hand-Rubbed Antique Brass | Clear Glass

**E TOB5702BZ/HAB-CG**  
Bronze | Brass | Clear Glass



CEILING | LANTERNS



A | **CHC2178PN**  
Polished Nickel

A | **CHC2178GI**  
Gilded Iron

A | **CHC2178AI**  
Aged Iron

**A | DARLANA MEDIUM DOUBLE CAGE LANTERN**  
E. F. CHAPMAN  
  
**CHC2178**  
Fixture: 24.5" H | W: 17" | Canopy: 6" Round  
Socket: 3 - E12 Candelabra | Bulb: 3 - 60 C  
©EFC DESIGNS

**B | DARLANA LARGE DOUBLE CAGE LANTERN**  
E. F. CHAPMAN

**CHC2179**  
Fixture: 34" H | W: 24" | Canopy: 7.5" Round  
Socket: 4 - E12 Candelabra | Bulb: 4 - 40 C  
©EFC DESIGNS



B | **CHC2179PN**  
Polished Nickel

B | **CHC2179GI**  
Gilded Iron

B | **CHC2179AI**  
Aged Iron

opposite page

**C | DARLANA EXTRA LARGE DOUBLE CAGE LANTERN**  
E. F. CHAPMAN  
  
**CHC2199**  
Fixture: 42" H | W: 29" | Canopy: 6" Round  
Socket: 4 - E12 Candelabra | Bulb: 4 - 60 C  
©EFC DESIGNS

C | **CHC2179GI**  
Gilded Iron



C | **CHC2199PN**  
Polished Nickel



C | **CHC2199AI**  
Aged Iron



A | **CHC2165PN**  
Polished Nickel



A | **CHC2165AI**  
Aged Iron



A | **CHC2165AB**  
Antique-Burnished Brass

opposite page

A | **DARLANA MEDIUM LANTERN**  
E. F. CHAPMAN

**CHC2165**  
Fixture: 24.5" H | W: 17" | Canopy: 6" Round  
Socket: 4 - E12 Candelabra | Bulb: 4 - 60 C  
**Additional Options:**  
Old White (OW)  
Gilded Iron (GI)  
©EFC DESIGNS



B | **CHC2176PN**  
Polished Nickel



B | **CHC2176GI**  
Gilded Iron



B | **CHC2176AI**  
Aged Iron



C | **CHC2177PN**  
Polished Nickel



C | **CHC2177GI**  
Gilded Iron



C | **CHC2177AI**  
Aged Iron

B | **DARLANA LARGE LANTERN**  
E. F. CHAPMAN

**CHC2176**  
Fixture: 34" H | W: 24" | Canopy: 7.5" Round  
Socket: 6 - E12 Candelabra | Bulb: 6 - 60 C  
©EFC DESIGNS

C | **DARLANA EXTRA LARGE LANTERN**  
E. F. CHAPMAN

**CHC2177**  
Fixture: 42" H | W: 29" | Canopy: 7.5" Round  
Socket: 6 - E12 Candelabra | Bulb: 6 - 60 C  
©EFC DESIGNS

**A DARLANA MINI LANTERN**  
E. F. CHAPMAN

**CHC2175**  
Fixture: 14" H | W: 9.75" | Canopy: 5.5" Round  
Socket: 3 - E12 Candelabra | Bulb: 3 - 60 C  
©EFC DESIGNS



**A** | **CHC2175PN**  
Polished Nickel

**A** | **CHC2175GI**  
Gilded Iron

**A** | **CHC2175AI**  
Aged Iron

**B DARLANA SMALL LANTERN**  
E. F. CHAPMAN

**CHC2164**  
Fixture: 18" H | W: 12.5" | Canopy: 5.5" Round  
Socket: 4 - E12 Candelabra | Bulb: 4 - 60 C  
©EFC DESIGNS



**B** | **CHC2164PN**  
Polished Nickel

**B** | **CHC2164GI**  
Gilded Iron

**B** | **CHC2164AI**  
Aged Iron

**C DARLANA MEDIUM TALL LANTERN**  
E. F. CHAPMAN

**CHC2185**  
H: 18" | W: 7.5" | Canopy: 5.5" Round  
Socket: 2 - E12 Candelabra | Bulb: 2 - 60 C  
©EFC DESIGNS



**C** | **CHC2185PN**  
Polished Nickel

**C** | **CHC2185GI**  
Gilded Iron

**C** | **CHC2185AI**  
Aged Iron

**D DARLANA MEDIUM WIDE LANTERN**  
E. F. CHAPMAN

**CHC2187**  
H: 25" | W: 28" | Canopy: 7.5" Round  
Socket: 4 - E12 Candelabra | Bulb: 4 - 60 C  
©EFC DESIGNS

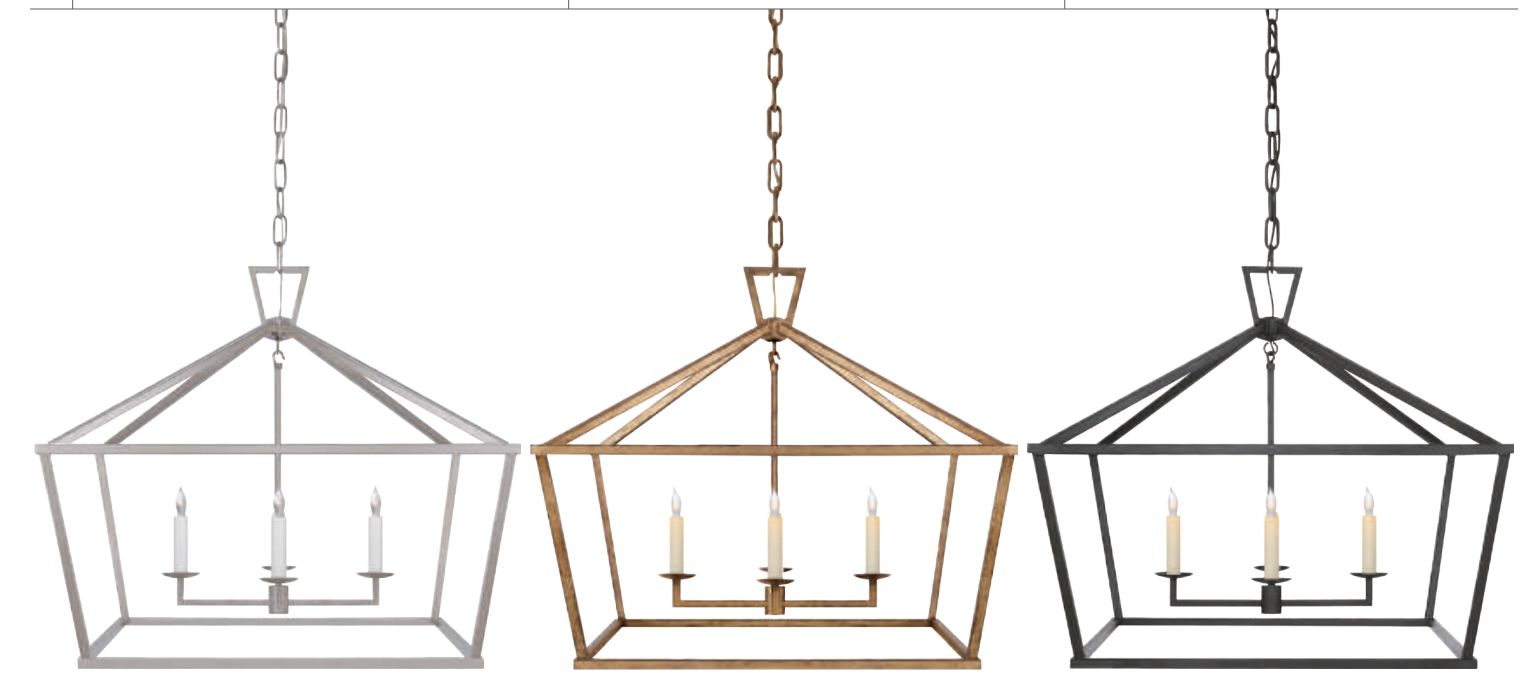

**D** | **CHC2187PN**  
Polished Nickel

**D** | **CHC2187GI**  
Gilded Iron

**D** | **CHC2187AI**  
Aged Iron



**A** | **SL5870PN**  
Polished Nickel | Clear Glass

**A** | **SL5870HAB**  
Hand-Rubbed Antique Brass | Clear Glass

**A** | **SL5870BR**  
Blackened Rust | Clear Glass

**A** | **CORNICE SEMI-FLUSH LANTERN**  
E. F. CHAPMAN

**SL5870**  
O/A H: 16.5" | W: 9.5" | Canopy: 6" Round  
Socket: 3 - E12 Candelabra | Bulb: 3 - 60 C  
**Additional Options:**  
Bronze | Clear Glass (BZ)  
©EFC DESIGNS

**B** | **CORNICE SMALL LANTERN**  
E. F. CHAPMAN

**SL5871**  
H: 24" | W: 14.5" | Canopy: 6" Round  
Socket: 4 - E12 Candelabra | Bulb: 4 - 60 C  
**Additional Options:**  
Blackened Rust | Clear Glass (BR)  
\* Custom Height Available (22.5" Minimum)  
©EFC DESIGNS

**C** | **CORNICE LARGE LANTERN**  
E. F. CHAPMAN

**SL5872**  
H: 36" | W: 20" | Canopy: 6" Round  
Socket: 4 - E12 Candelabra | Bulb: 4 - 60 C  
**Additional Options:**  
Bronze | Clear Glass (BZ)  
\* Custom Height Available (41" Minimum)  
©EFC DESIGNS

**B** | **SL5871PN**  
Polished Nickel | Clear Glass

**B** | **SL5871HAB**  
Hand-Rubbed Antique Brass | Clear Glass

**B** | **SL5871BZ**  
Bronze | Clear Glass



**C** | **SL5872BR**  
Blackened Rust | Clear Glass



**C** | **SL5872PN**  
Polished Nickel | Clear Glass



**C** | **SL5872HAB**  
Hand-Rubbed Antique Brass | Clear Glass



**A** | **CHC5610PN-CG**  
Polished Nickel | Clear Glass

**A** | **CHC5610AN-CG**  
Antique Nickel | Clear Glass

**B** | **CHC5611AB-CG**  
Antique-Burnished Brass | Clear Glass

**B** | **CHC5611BZ-CG**  
Bronze | Clear Glass



**C** | **CHC5612PN-CG**  
Polished Nickel | Clear Glass

**C** | **CHC5612AN-CG**  
Antique Nickel | Clear Glass

**C** | **CHC5612AB-CG**  
Antique-Burnished Brass | Clear Glass

**C** | **CHC5612BZ-CG**  
Bronze | Clear Glass

**A** | **LAUNCETON SMALL SQUARE LANTERN**  
E. F. CHAPMAN

**CHC5610**  
H: 25.75" | W: 12.5" | Canopy: 5.25" Round  
Socket: 4 - E12 Candelabra | Bulb: 4 - 60 C  
**Additional Options:**  
Antique-Burnished Brass | Clear Glass (AB-CG)  
Bronze | Clear Glass (BZ-CG)  
©EFC DESIGNS

**B** | **LAUNCETON MEDIUM SQUARE LANTERN**  
E. F. CHAPMAN

**CHC5611**  
H: 34.5" | W: 17" | Canopy: 5.25" Round  
Socket: 4 - E12 Candelabra | Bulb: 4 - 60 C  
**Additional Options:**  
Antique Nickel | Clear Glass (AN-CG)  
Polished Nickel | Clear Glass (PN-CG)  
©EFC DESIGNS

**C** | **LAUNCETON LARGE SQUARE LANTERN**  
E. F. CHAPMAN

**CHC5612**  
H: 46" | W: 24" | Canopy: 6.25" Round  
Socket: 4 - E12 Candelabra | Bulb: 4 - 60 C  
\* Requires Special Assembly and Installation  
©EFC DESIGNS

**B** | **CHC5611AB-CG**  
Antique-Burnished Brass | Clear Glass





**A S5167PN-CG**  
Polished Nickel | Clear Glass



**A S5167HAB-CG**  
Hand-Rubbed Antique Brass | Clear Glass



**A S5167HAB-CG**  
Hand-Rubbed Antique Brass | Clear Glass



opposite page  
**A PRESIDIO MEDIUM LANTERN**  
IAN K. FOWLER  
**S5167**  
O/A H: 69" | Fixture: 23" H | W: 18"  
Canopy: 5.5" Square  
Socket: E26 Keyless | Bulb: 60 T  
\* Custom Height Available (28" Minimum)

**B SC5020PN-WG**  
Polished Nickel | White Glass



**B MARIN LANTERN**  
ERIC COHLER  
**SC5020**  
H: 44" | Fixture: 21" H | W: 20.75"  
Canopy: 5" Round  
Socket: 6 - E17 Keyless | Bulb: 6 - 25 T  
**Additional Options:**  
Bronze | White Glass (BZ-WG)  
\* Custom Height Available (29" Minimum)

**B SC5020AB-WG**  
Antique-Burnished Brass | White Glass

**C ODEUM MEDIUM LANTERN**  
BARBARA BARRY  
**BBL5102**  
O/A H: 55.5" | Fixture: 32.25" H | W: 17"  
Canopy: 5.5" Round  
Socket: 2 - E26 Keyless | Bulb: 2 - 60 A  
\* Custom Height Available (36" Minimum)



**C BBL5102PN-FA**  
Polished Nickel | Frosted Acrylic



**C BBL5102PWT-FA**  
Pewter | Frosted Acrylic



**C BBL5102BZ-FA**  
Bronze | Frosted Acrylic



**C BBL5102SB-FA**  
Soft Brass | Frosted Acrylic





**A** | **CHC2201PN-CG**  
Polished Nickel | Clear Glass



**A** | **CHC2201PN-CG**  
Polished Nickel | Clear Glass



**A** | **CHC2201AI-CG**  
Aged Iron | Clear Glass



**B** | **CHC2202PN-CG**  
Polished Nickel | Clear Glass



**B** | **CHC2202AI-CG**  
Aged Iron | Clear Glass

**A** | **DARLANA 16" PENDANT**  
E. F. CHAPMAN  
  
**CHC2201**  
H: 13.5" | W: 16.5" | Canopy: 6" Round  
Socket: 4 - E12 Candelabra | Bulb: 4 - 40 C  
©EFC DESIGNS

**B** | **DARLANA 24" PENDANT**  
E. F. CHAPMAN  
  
**CHC2202**  
H: 20.5" | W: 24.5" | Canopy: 6" Round  
Socket: 4 - E12 Candelabra | Bulb: 4 - 60 C  
©EFC DESIGNS

**C** | **EASTERLY SMALL PENDANT**  
E. F. CHAPMAN  
  
**CHC5055**  
H: 51.5" | Fixture: 11" H | W: 5.75"  
Canopy: 5.75" Square  
Socket: E26 Keyless | Bulb: 75 A  
**Additional Options:**  
Antique-Burnished Brass | White Glass (AB-WG)  
\* Custom Height Available (18" Minimum)  
©EFC DESIGNS



**C** | **CHC5055PN-WG**  
Polished Nickel | White Glass



**C** | **CHC5055BZ-WG**  
Bronze | White Glass



**A** S5193AI-CG  
Aged Iron | Clear Glass

**A HALLE MEDIUM LANTERN**  
IAN K. FOWLER

**S5193**  
H: 71.25" | Fixture: 36" H | W: 18"  
Canopy: 4.5" Round  
Socket: 4 - E26 Keyless | Bulb: 4 - 60 T  
**Additional Options:**  
Polished Nickel | Clear Glass (PN-CG)  
\* Custom Height Available (54.5" Minimum)

opposite page

**B HALLE PETITE LANTERN**  
IAN K. FOWLER

**S5190**  
O/A H: 55" | Fixture: 19.25" H | W: 6.75"  
Canopy: 4.5" Round  
Socket: E26 Keyless | Bulb: 60 T  
\* Custom Height Available (28" Minimum)

**C HALLE SMALL LANTERN**  
IAN K. FOWLER

**S5192**  
H: 62" | Fixture: 26.25" H | W: 14"  
Canopy: 4.5" Round  
Socket: 4 - E26 Keyless | Bulb: 4 - 60 T  
\* Custom Height Available (41" Minimum)

**D MILO SMALL PENDANT**  
IAN K. FOWLER

**S5321**  
H: 47.75" | Fixture: 11" H | W: 8"  
Canopy: 5.75" Square  
Socket: E12 Candelabra | Bulb: 40 B  
**Additional Options:**  
Aged Iron | Linen (AI-L)  
\* Custom Height Available (18.25" Minimum)

**E MILO MEDIUM PENDANT**  
IAN K. FOWLER

**S5323**  
H: 58.75" | Fixture: 22" H | W: 15"  
Canopy: 5.75" Square  
Socket: 4 - E12 Candelabra | Bulb: 4 - 40 B  
**Additional Options:**  
Polished Nickel | Linen (PN-L)  
\* Custom Height Available (28.75" Minimum)

**F MILO LARGE PENDANT**  
IAN K. FOWLER

**S5325**  
H: 66.25" | Fixture: 29.5" H | W: 20"  
Canopy: 5.75" Square  
Socket: 4 - E12 Candelabra | Bulb: 4 - 40 B  
\* Requires Special Assembly and Installation

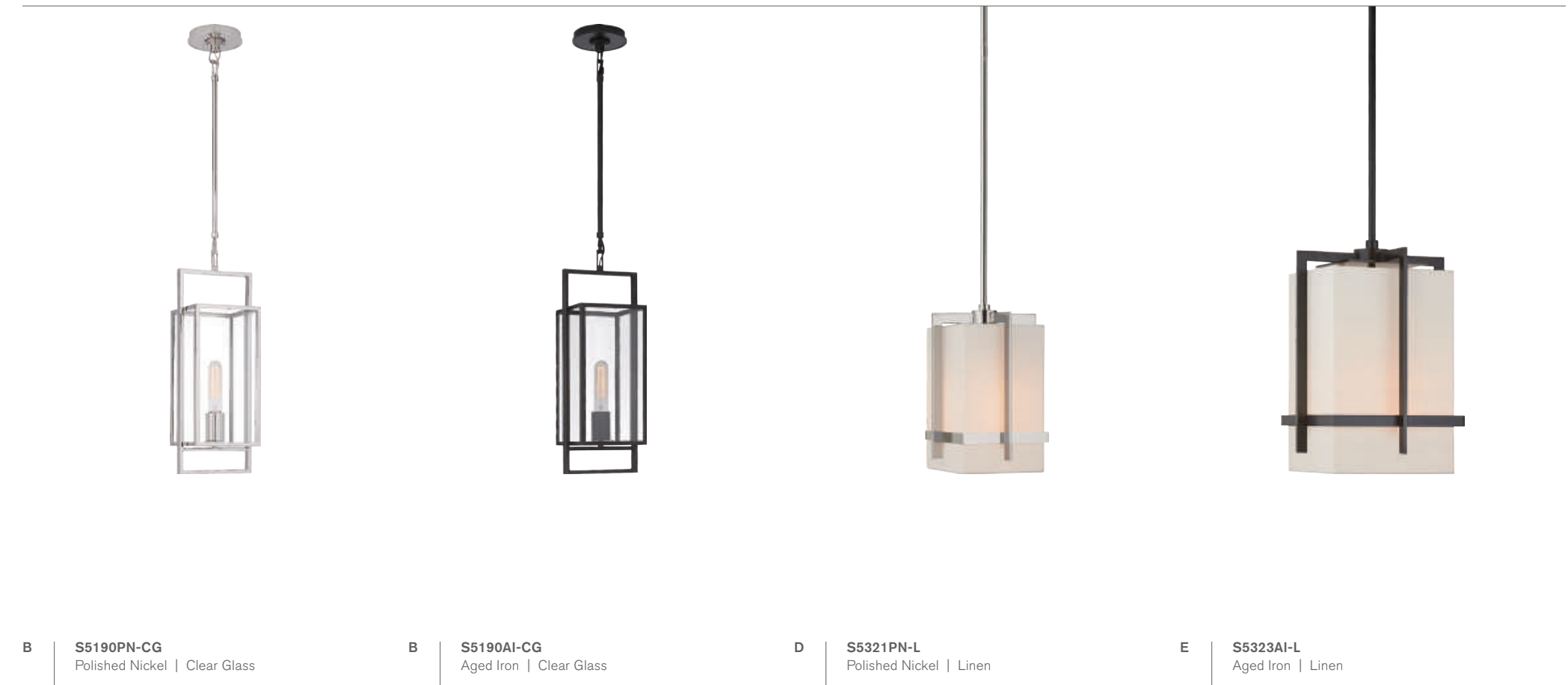

**B** S5190PN-CG  
Polished Nickel | Clear Glass

**B** S5190AI-CG  
Aged Iron | Clear Glass

**D** S5321PN-L  
Polished Nickel | Linen

**E** S5323AI-L  
Aged Iron | Linen

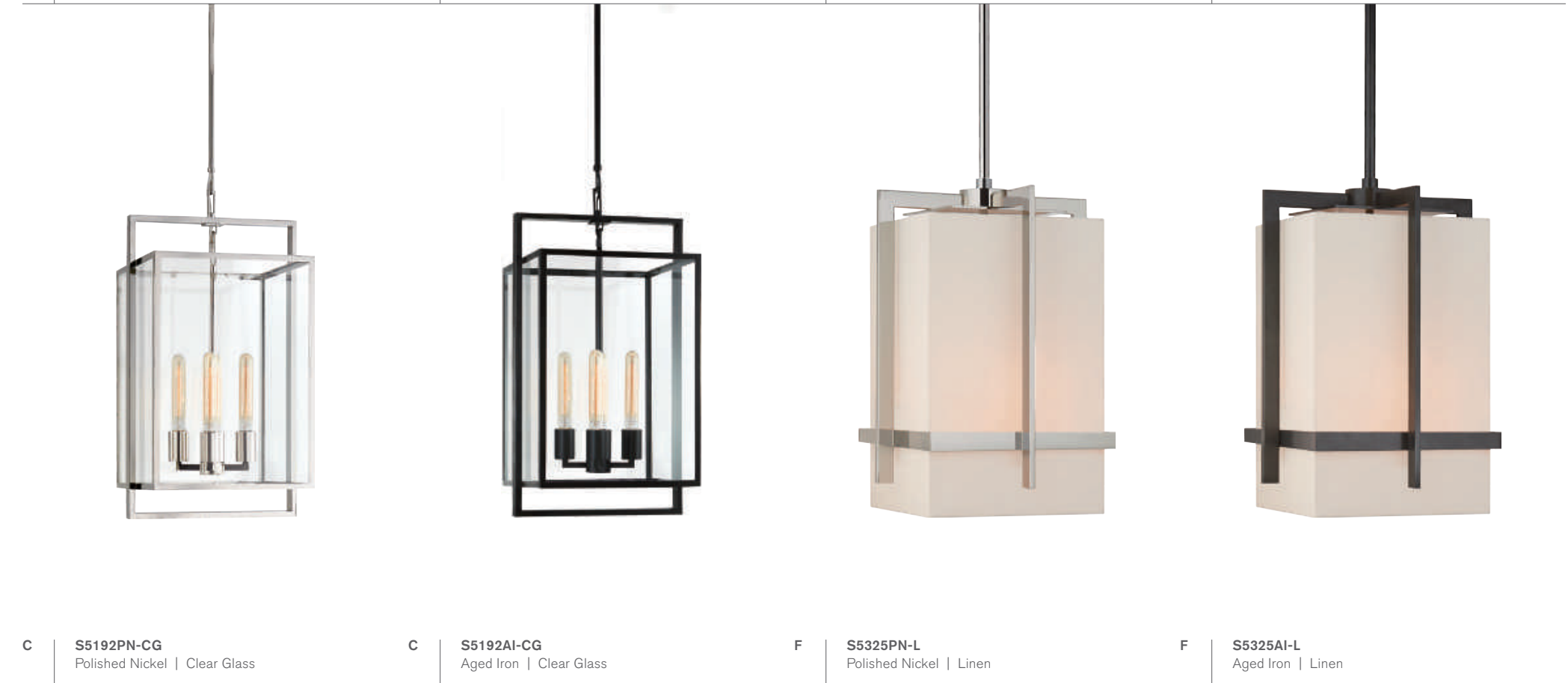

**C** S5192PN-CG  
Polished Nickel | Clear Glass

**C** S5192AI-CG  
Aged Iron | Clear Glass

**F** S5325PN-L  
Polished Nickel | Linen

**F** S5325AI-L  
Aged Iron | Linen



**A CAGED SMALL LANTERN**  
ERIC COHLER  
**SC5159**  
H: 16" | W: 16" | Canopy: 7" Round  
Socket: E26 Keyless | Bulb: 60 B  
Shade: 11" Cube

**B CAGED MEDIUM LANTERN**  
ERIC COHLER  
**SC5160**  
H: 22" | W: 22" | Canopy: 7" Round  
Socket: 2 - E26 Keyless | Bulb: 2 - 60 A  
Shade: 15.25" Cube

**A SC5159PN**  
Polished Nickel | Natural Paper

**A SC5159HAB**  
Hand-Rubbed Antique Brass | Natural Paper

**A SC5159BZ**  
Bronze | Natural Paper



**B SC5160PN**  
Polished Nickel | Natural Paper

**B SC5160HAB**  
Hand-Rubbed Antique Brass | Natural Paper

**B SC5160BZ**  
Bronze | Natural Paper

opposite page

**C STAR LANTERN**  
J. RANDALL POWERS

**SP5004**  
H: 29" | W: 18" | Canopy: 5.75" Round  
Socket: 4 - E12 Candelabra | Bulb: 4 - 60 C

**D OSBORNE LANTERN**  
E. F. CHAPMAN

**CHC2217**  
H: 22" | W: 18" | Canopy: 5.5" Square  
Socket: 3 - E12 Candelabra | Bulb: 3 - 60 C  
**Additional Options:**  
Gilded Iron (GI)  
©EFC DESIGNS

**C SP5004AI**  
Aged Iron



**D CHC2217PN**  
Polished Nickel



**D CHC2217AI**  
Aged Iron



**A** | **SP5001HAB**  
Hand-Rubbed Antique Brass | Clear Glass



**A** | **SP5001BZ**  
Bronze | Clear Glass



**A** | **SP5001PN**  
Polished Nickel | Clear Glass

opposite page

**A** | **GREGGORY SMALL LANTERN**  
J. RANDALL POWERS

**SP5001**  
H: 19" | W: 12" | Canopy: 5.75" Round  
Socket: 4 - E12 Candelabra | Bulb: 4 - 60 C



**B** | **SP5002PN**  
Polished Nickel | Clear Glass



**B** | **SP5002HAB**  
Hand-Rubbed Antique Brass | Clear Glass



**B** | **SP5002BZ**  
Bronze | Clear Glass



**B** | **GREGGORY MEDIUM LANTERN**  
J. RANDALL POWERS

**SP5002**  
H: 27.75" | W: 18" | Canopy: 5.75" Round  
Socket: 4 - E12 Candelabra | Bulb: 4 - 60 C



**C** | **GREGGORY LARGE LANTERN**  
J. RANDALL POWERS

**SP5003**  
H: 36.5" | W: 24" | Canopy: 5.75" Round  
Socket: 4 - E12 Candelabra | Bulb: 4 - 60 C



**C** | **SP5003PN**  
Polished Nickel | Clear Glass

**C** | **SP5003HAB**  
Hand-Rubbed Antique Brass | Clear Glass

**C** | **SP5003BZ**  
Bronze | Clear Glass



**A ARCH TOP MINI LANTERN**  
E. F. CHAPMAN

**CHC3420**  
H: 16.75" | W: 8.25" | Canopy: 5.75" Round  
Socket: 3 - E12 Candelabra | Bulb: 3 - 60 C  
**Additional Options:**  
Bronze | Clear Glass (BZ)  
©EFC DESIGNS

**B ARCH TOP SMALL LANTERN**  
E. F. CHAPMAN

**CHC3421**  
H: 24" | W: 14.5" | Canopy: 5.75" Round  
Socket: 4 - E12 Candelabra | Bulb: 4 - 60 C  
**Additional Options:**  
Antique-Burnished Brass | Clear Glass (AB)  
Polished Nickel | Clear Glass (PN)  
©EFC DESIGNS

**C ARCH TOP MEDIUM LANTERN**  
E. F. CHAPMAN

**CHC3422**  
H: 29.5" | W: 17.5" | Canopy: 5.75" Round  
Socket: 4 - E12 Candelabra | Bulb: 4 - 60 C  
**Additional Options:**  
Bronze | Clear Glass (BZ)  
©EFC DESIGNS

**D ARCH TOP LARGE LANTERN**  
E. F. CHAPMAN

**CHC3425**  
H: 34.25" | W: 20.25" | Canopy: 5.75" Round  
Socket: 5 - E12 Candelabra | Bulb: 5 - 60 C  
**Additional Options:**  
Antique-Burnished Brass | Clear Glass (AB)  
Polished Nickel | Clear Glass (PN)  
©EFC DESIGNS

opposite page

**E EDWARDIAN ARCH TOP MEDIUM LANTERN**  
E. F. CHAPMAN

**CHC3423**  
H: 29.5" | W: 18" | Canopy: 5.75" Round  
Socket: 4 - E12 Candelabra | Bulb: 4 - 60 C  
©EFC DESIGNS

**A CHC3420PN**  
Polished Nickel | Clear Glass

**A CHC3420AB**  
Antique-Burnished Brass | Clear Glass

**B CHC3421BZ**  
Bronze | Clear Glass



**C CHC3422PN**  
Polished Nickel | Clear Glass

**C CHC3422AB**  
Antique-Burnished Brass | Clear Glass

**D CHC3425BZ**  
Bronze | Clear Glass



**E CHC3423AB**  
Antique-Burnished Brass | Clear Glass



**E CHC3423PN**  
Polished Nickel | Clear Glass



**E CHC3423BZ**  
Bronze | Clear Glass



**A** | **CHC3453AB-CG**  
Antique-Burnished Brass | Clear Glass

**A** | **CHC3453BZ-CG**  
Bronze | Clear Glass

**B** | **CHC3438PN-CG**  
Polished Nickel | Clear Glass

**B** | **CHC3438AN-CG**  
Antique Nickel | Clear Glass



**C** | **CHC3439AB-CG**  
Antique-Burnished Brass | Clear Glass

**C** | **CHC3439BZ-CG**  
Bronze | Clear Glass

**D** | **CHC3440PN-CG**  
Polished Nickel | Clear Glass

**D** | **CHC3440AN-CG**  
Antique Nickel | Clear Glass

**A** | **PLANTATION MEDIUM WIDE LANTERN**  
E. F. CHAPMAN

**CHC3453**  
H: 25.5" | W: 29" | Canopy: 5.5" Round  
Socket: 8 - E12 Candelabra | Bulb: 8 - 60 C  
**Additional Options:**  
Polished Nickel | Clear Glass (PN-CG)  
©EFC DESIGNS

**B** | **PLANTATION SMALL LANTERN**  
E. F. CHAPMAN

**CHC3438**  
H: 20" | W: 13.75" | Canopy: 5.5" Round  
Socket: 4 - E12 Candelabra | Bulb: 4 - 60 C  
**Additional Options:**  
Antique-Burnished Brass | Clear Glass (AB-CG)  
Bronze | Clear Glass (BZ-CG)  
©EFC DESIGNS

**C** | **PLANTATION MEDIUM LANTERN**  
E. F. CHAPMAN

**CHC3439**  
H: 31" | W: 21" | Canopy: 5.5" Round  
Socket: 4 - E12 Candelabra | Bulb: 4 - 60 C  
**Additional Options:**  
Antique Nickel | Clear Glass (AN-CG)  
Polished Nickel | Clear Glass (PN-CG)  
©EFC DESIGNS

**D** | **PLANTATION LARGE LANTERN**  
E. F. CHAPMAN

**CHC3440**  
H: 42.75" | W: 28.75" | Canopy: 7" Round  
Socket: 6 - E12 Candelabra | Bulb: 6 - 60 C  
**Additional Options:**  
Bronze | Clear Glass (BZ-CG)  
©EFC DESIGNS



**C** | **CHC3440AB-CG**  
Antique-Burnished Brass | Clear Glass



C | KS5145G  
Gild

**A CAVANAGH MINI LANTERN**  
KATE SPADE NEW YORK

**KS5143**  
Fixture: 18" H | W: 11.5" | Canopy: 5.5" Round  
Socket: 4 - E12 Candelabra | Bulb: 4 - 40 G  
**Additional Options:**  
Coral | Gild (CRL/G)  
French Navy | Polished Nickel (NVY/PN)  
Polished Nickel (PN)  
\* Ships with 3 Feet of Chain

**B CAVANAGH SMALL LANTERN**  
KATE SPADE NEW YORK

**KS5144**  
Fixture: 23" H | W: 13.75" | Canopy: 5.5" Round  
Socket: 4 - E12 Candelabra | Bulb: 4 - 40 G  
**Additional Options:**  
Gild (G)  
Light Cream | Gild (LC/G)  
Polished Nickel (PN)

**C CAVANAGH MEDIUM LANTERN**  
KATE SPADE NEW YORK

**KS5145**  
Fixture: 32" H | W: 19" | Canopy: 5.5" Round  
Socket: 4 - E12 Candelabra | Bulb: 4 - 40 G  
**Additional Options:**  
Coral | Gild (CRL/G)  
Light Cream | Gild (LC/G)  
French Navy | Polished Nickel (NVY/PN)

**D CAVANAGH LARGE LANTERN**  
KATE SPADE NEW YORK

**KS5146**  
Fixture: 39.5" H | W: 24" | Canopy: 5.5" Round  
Socket: 6 - E12 Candelabra | Bulb: 6 - 40 G  
**Additional Options:**  
Gild (G)  
Light Cream | Gild (LC/G)  
Polished Nickel (PN)



A | KS5143LC/G  
Light Cream | Gild

A | KS5143G  
Gild

B | KS5144CRL/G  
Coral | Gild

B | KS5144NVY/PN  
French Navy | Polished Nickel

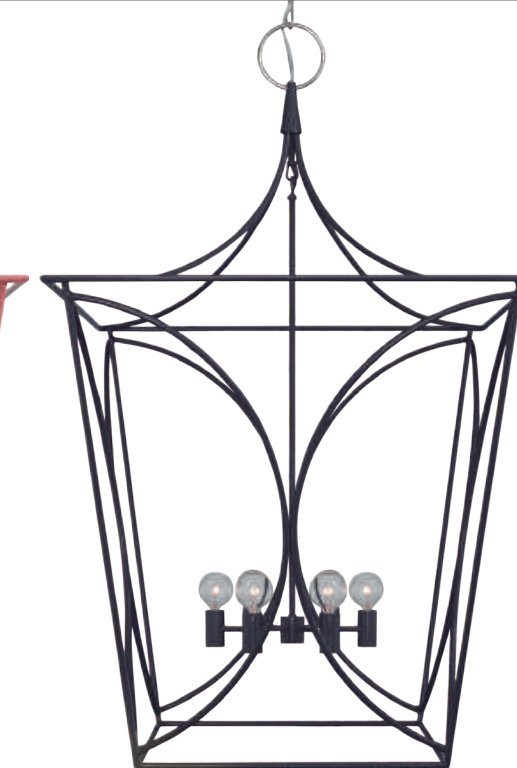
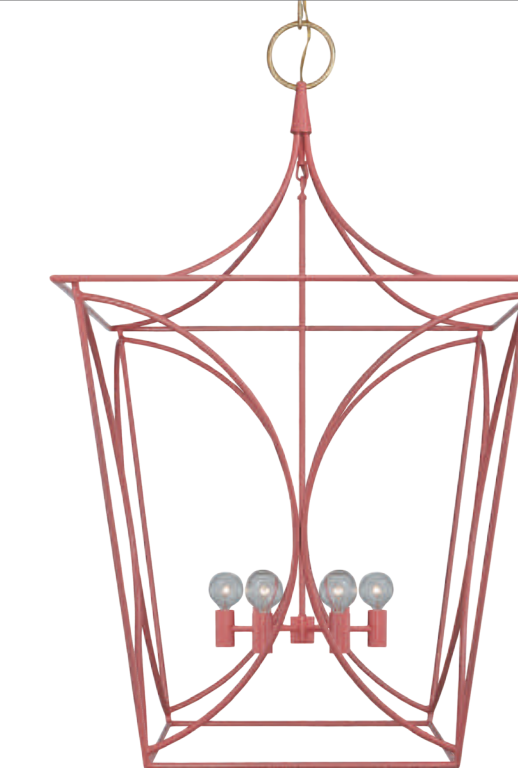
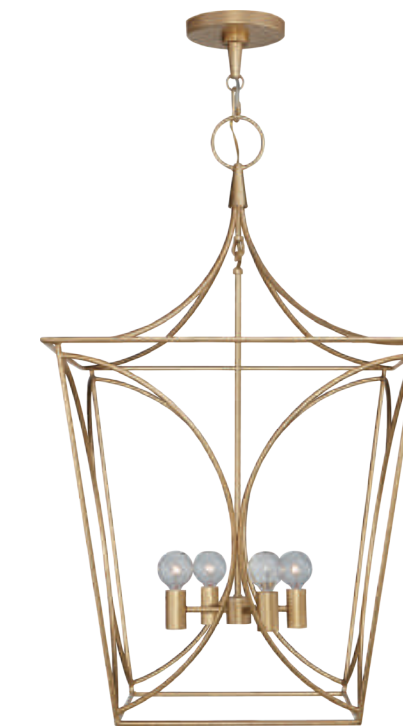
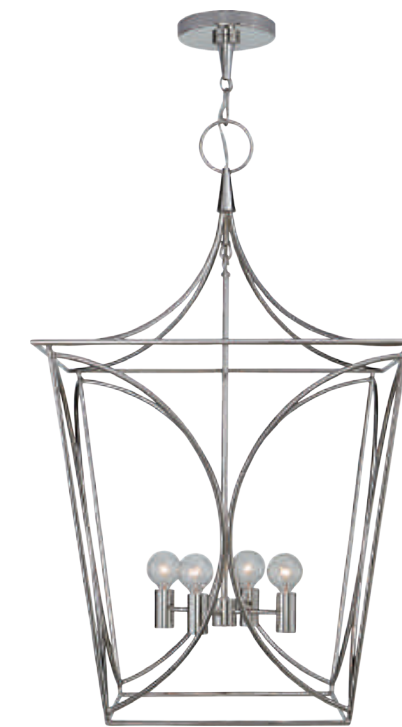

C | KS5145PN  
Polished Nickel

C | KS5145G  
Gild

D | KS5146CRL/G  
Coral | Gild

D | KS5146NVY/PN  
French Navy | Polished Nickel



**A GRAMERCY MEDIUM LANTERN**  
E. F. CHAPMAN  
**CHC2186**  
H: 29" | W: 17" | Canopy: 6" Round  
Socket: 4 - E12 Candelabra | Bulb: 4 - 60 C  
©EFC DESIGNS

**B BRIGHTON PAGODA LANTERN**  
E. F. CHAPMAN  
**CHC3444**  
Fixture: 28.25" H | W: 20.25" | Canopy: 6" Round  
Socket: 4 - E12 Candelabra | Bulb: 4 - 60 C  
**Additional Options:**  
Burnished Silver Leaf (BSL)  
©EFC DESIGNS

**C ARIA MEDIUM SQUARE LANTERN**  
JULIE NEILL  
**JN5613**  
H: 30" | W: 24" | Canopy: 5" Round  
Socket: 4 - E12 Candelabra | Bulb: 4 - 60 C  
**Additional Options:**  
Burnished Silver Leaf (BSL)



**C JN5613PW**  
Plaster White



**C JN5613AGL**  
Antique Gold Leaf

opposite page  
**D CADDO MEDIUM LANTERN**  
JULIE NEILL

**JN5020**  
H: 32" | W: 17" | Canopy: 5.5" Round  
Socket: 4 - E12 Candelabra | Bulb: 4 - 60 C

**D JN5020CEL/G-CG**  
Celadon | Gild | Clear Glass



**D JN5020SW/G-CG**  
Soft White | Gild | Clear Glass



**D JN5020MBK/G-CG**  
Matte Black | Gild | Clear Glass



**A CHC2186GI**  
Gilded Iron

**A CHC2186AI**  
Aged Iron



**B CHC3444GI**  
Gilded Iron

**B CHC3444AI**  
Aged Iron





**A** | **CHC5050WZ**  
Weathered Zinc | Clear Glass

**A** | **ELSINORE MEDIUM HANGING LANTERN**  
E. F. CHAPMAN

**CHC5050**  
H: 21.25" | W: 14.5" | Canopy: 6" Round  
Socket: 4 - E12 Candelabra | Bulb: 4 - 60 C  
**Additional Options:**  
Black (BLK)  
Old White (OW)  
©EFC DESIGNS

opposite page

**B** | **ELSINORE LARGE HANGING LANTERN**  
E. F. CHAPMAN

**CHC5051**  
H: 26.5" | W: 18.25" | Canopy: 6" Round  
Socket: 4 - E12 Candelabra | Bulb: 4 - 40 C  
**Additional Options:**  
Weathered Zinc (WZ-CG)  
\* Finish Will Patina in Full Weather  
\* Extreme Conditions May Deteriorate Finish

**C** | **ELSINORE EXTRA-LARGE HANGING LANTERN**  
E. F. CHAPMAN

**CHC5052**  
H: 31.75" | W: 21.75" | Canopy: 8" Round  
Socket: 4 - E12 Candelabra | Bulb: 4 - 40 C  
**Additional Options:**  
Weathered Zinc (WZ-CG)  
\* Finish Will Patina in Full Weather  
\* Extreme Conditions May Deteriorate Finish

**D** | **HOLBORN SMALL LANTERN**  
E. F. CHAPMAN

**CHC2215**  
H: 34.5" | W: 14" | Canopy: 5.5" Round  
Socket: 4 - E12 Candelabra | Bulb: 4 - 60 C  
©EFC DESIGNS

**E** | **HOLBORN LARGE LANTERN**  
E. F. CHAPMAN

**CHC2216**  
H: 45" | W: 18.25" | Canopy: 5.5" Round  
Socket: 4 - E12 Candelabra | Bulb: 4 - 60 C  
©EFC DESIGNS



**B** | **CHC5051OW-CG**  
Old White | Clear Glass



**B** | **CHC5051BLK-CG**  
Black | Clear Glass



**D** | **CHC2215OW**  
Old White | Clear Glass



**D** | **CHC2215AI**  
Aged Iron | Clear Glass



**C** | **CHC5052OW-CG**  
Old White | Clear Glass



**C** | **CHC5052BLK-CG**  
Black | Clear Glass



**E** | **CHC2216OW**  
Old White | Clear Glass



**E** | **CHC2216AI**  
Aged Iron | Clear Glass



**A WARWICK MEDIUM LANTERN**  
E. F. CHAPMAN  
**CHC3568**  
Fixture: 26.25" H | W: 13.5" | Canopy: 5.5" Round  
Socket: 3 - E12 Candelabra | Bulb: 3 - 60 C  
©EFC DESIGNS

**B DUMFRIES LARGE LANTERN**  
E. F. CHAPMAN  
**CHC3310**  
Fixture: 43.5" H | W: 21.75" | Canopy: 7.5" Round  
Socket: 4 - E12 Candelabra | Bulb: 4 - 60 C  
©EFC DESIGNS



**C SK5300AZ**  
Antique Zinc | Clear Glass

**A CHC3568AB-CG**  
Antique-Burnished Brass | Clear Glass

**A CHC3568WVG-CG**  
Weathered Verdigris | Clear Glass



**C HONORE SMALL LANTERN**  
SUZANNE KASLER  
**SK5300**  
H: 21" | W: 12" | Canopy: 4.75" Round  
Socket: 3 - E12 Candelabra | Bulb: 3 - 60 C

**D HONORE LANTERN**  
SUZANNE KASLER

**SK5301**  
H: 27" | W: 16" | Canopy: 4.75" Round  
Socket: 3 - E12 Candelabra | Bulb: 3 - 60 C



**D SK5301AZ**  
Antique Zinc | Clear Glass

**B CHC3310AB-CG**  
Antique-Burnished Brass | Clear Glass

**B CHC3310WVG-CG**  
Weathered Verdigris | Clear Glass



**E SK5007VG**  
Verdigris | Clear Glass

**E BRANTLEY LANTERN**  
SUZANNE KASLER  
**SK5007**  
H: 21.5" | W: 12" | Canopy: 5.5" Round  
Socket: 2 - E12 Candelabra | Bulb: 2 - 60 C



**E SK5007VG**  
Verdigris | Clear Glass



**A MYKONOS MINI LANTERN**  
E. F. CHAPMAN  
**CHC2190**  
H: 13" | W: 8.75" | Canopy: 5" Square  
Socket: 4 - E12 Candelabra | Bulb: 4 - 40 C  
**Additional Options:**  
Aged Iron (AI)  
©EFC DESIGNS

**B MYKONOS MEDIUM LANTERN**  
E. F. CHAPMAN  
**CHC2161**  
H: 25.25" | W: 17.25" | Canopy: 6.5" Oct.  
Socket: 4 - E12 Candelabra | Bulb: 4 - 60 C  
**Additional Options:**  
Gilded Iron (GI)  
©EFC DESIGNS

**C FRENCH MARKET SMALL LANTERN**  
E. F. CHAPMAN  
**CHC3413**  
H: 16.75" | W: 9.5" | Canopy: 5.75" Round  
Socket: 3 - E12 Candelabra | Bulb: 3 - 60 C  
©EFC DESIGNS

**D FRENCH MARKET MEDIUM LANTERN**  
E. F. CHAPMAN  
**CHC3414**  
H: 30.5" | W: 16.5" | Canopy: 5.5" Round  
Socket: 3 - E12 Candelabra | Bulb: 3 - 60 C  
©EFC DESIGNS

**E DARLANA SMALL FANCY LANTERN**  
E. F. CHAPMAN  
**CHC2180**  
H: 22" | W: 12.75" | Canopy: 5.5" Round  
Socket: 4 - E12 Candelabra | Bulb: 4 - 60 C  
**Additional Options:**  
Polished Nickel (PN)  
©EFC DESIGNS

**F DARLANA MEDIUM FANCY LANTERN**  
E. F. CHAPMAN  
**CHC2181**  
H: 29.25" | W: 17.25" | Canopy: 5.5" Round  
Socket: 4 - E12 Candelabra | Bulb: 4 - 60 C  
**Additional Options:**  
Polished Nickel (PN)  
©EFC DESIGNS

**G DARLANA LARGE FANCY LANTERN**  
E. F. CHAPMAN  
**CHC2182**  
H: 38" | W: 22" | Canopy: 6.5" Round  
Socket: 6 - E12 Candelabra | Bulb: 6 - 60 C  
©EFC DESIGNS

**A CHC2190GI**  
Gilded Iron

**B CHC2161AI**  
Aged Iron | Clear Glass



**C CHC3413GI**  
Gilded Iron | Clear Glass



**D CHC3414GI**  
Gilded Iron | Clear Glass



**C CHC3413BR**  
Blackened Rust | Clear Glass



**D CHC3414BR**  
Blackened Rust | Clear Glass



**E CHC2180GI**  
Gilded Iron



**G CHC2182PN**  
Polished Nickel



**E CHC2180AI**  
Aged Iron



**G CHC2182GI**  
Gilded Iron



**F CHC2181GI**  
Gilded Iron



**G CHC2182AI**  
Aged Iron

**F CHC2181AI**  
Aged Iron



**A** | **CHC2167PN-NP**  
Polished Nickel | Natural Paper



**A** | **CHC2167GI-NP**  
Gilded Iron | Natural Paper



**A** | **CHC2167AI-NP**  
Aged Iron | Natural Paper

opposite page

**A** | **GUSTAVIAN LANTERN**  
E. F. CHAPMAN

**CHC2167**  
H: 35.75" | W: 20" | Canopy: 5" Round  
Socket: 3 - E26 Keyless | Bulb: 3 - 40 A  
Shade: 16" x 16" x 17"  
©EFC DESIGNS



**B** | **CHC2224G**  
Gild



**B** | **CHC2224AI**  
Aged Iron



**C** | **CHC2160G**  
Gild



**C** | **CHC2160AI**  
Aged Iron

**B** | **DESMOND OPEN OVAL LANTERN**  
E. F. CHAPMAN

**CHC2224**  
H: 28.75" | W: 21" | Canopy: 5.5" Round  
Socket: 4 - E12 Candelabra | Bulb: 4 - 40 C  
©EFC DESIGNS

**C** | **DESMOND CAGE LANTERN**  
E. F. CHAPMAN

**CHC2160**  
H: 36" | W: 21" | Canopy: 5.5" Round  
Socket: 4 - E12 Candelabra | Bulb: 4 - 60 C  
©EFC DESIGNS



A CHC3109GI  
Gilded Iron

A CHC3109R  
Rust | Verdis Accent

B CHC3108GI  
Gilded Iron

B CHC3108R  
Rust | Verdis Accent

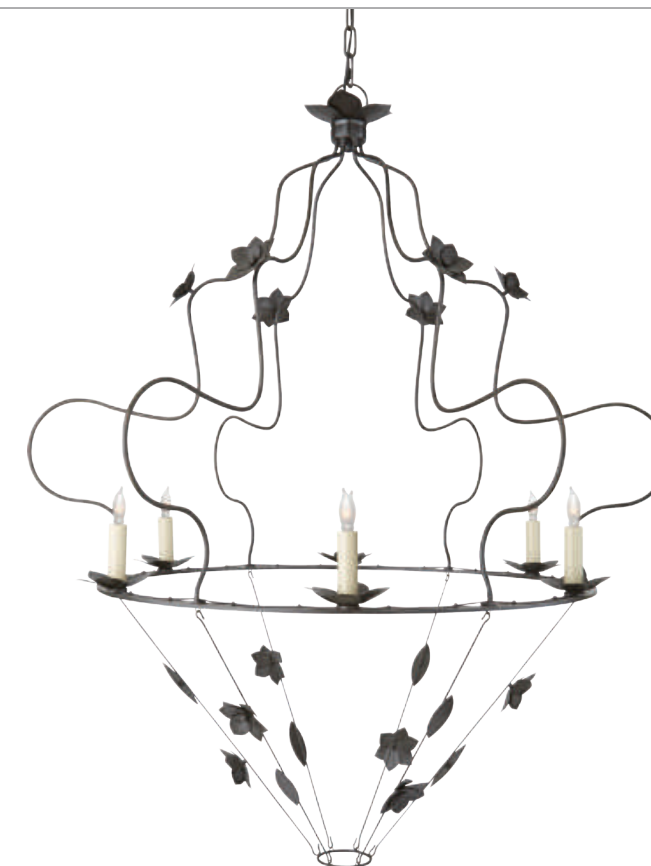
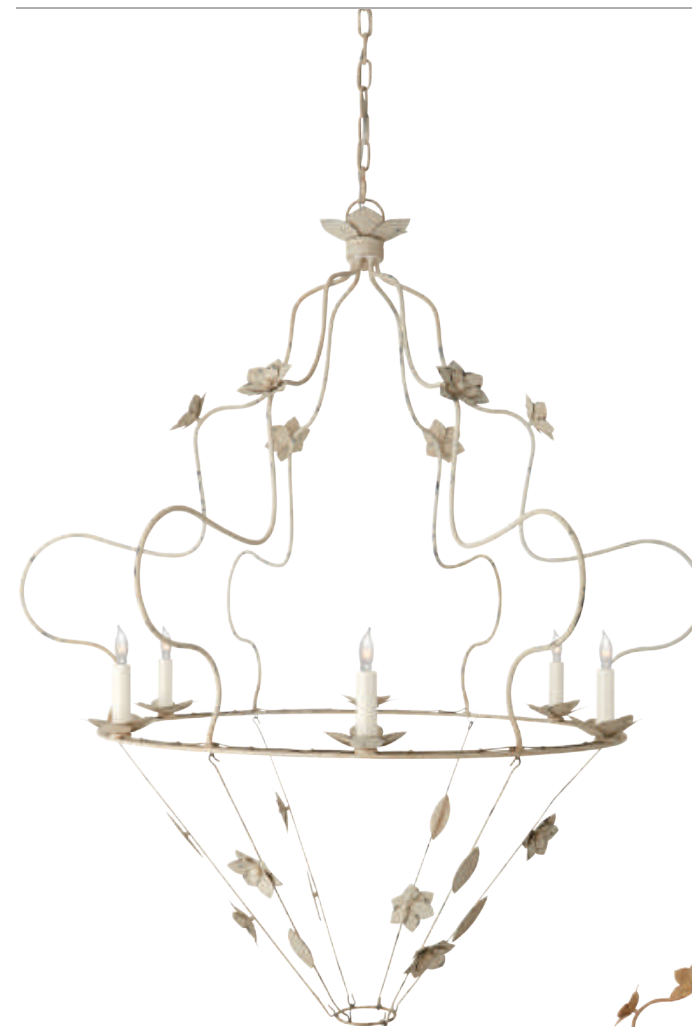

D NW5210OW  
Old White

D NW5210GI  
Gilded Iron

D NW5210AI  
Aged Iron

opposite page

A DIEGO PETITE LANTERN  
E. F. CHAPMAN

CHC3109  
H: 14" | W: 8" | Canopy: 5" Round  
Socket: 3 - E12 Candelabra | Bulb: 3 - 60 C  
©EFC DESIGNS

B DIEGO GRANDE LANTERN  
E. F. CHAPMAN

CHC3108  
H: 25" | W: 16" | Canopy: 5" Round  
Socket: 4 - E12 Candelabra | Bulb: 4 - 60 C  
©EFC DESIGNS

C LUCIANO MEDIUM ROUND LANTERN  
NIERMANN WEEKS

NW5205  
H: 30" | W: 18" | Canopy: 6" Round  
Socket: 4 - E12 Candelabra | Bulb: 4 - 40 G

D ARUNDEL GRANDE ORNATE CHANDELIER  
NIERMANN WEEKS

NW5210  
H: 47" | W: 40" | Canopy: 5" Round  
Socket: 6 - E12 Candelabra | Bulb: 6 - 60 C



**A** | **S5045BSL-L**  
Burnished Silver Leaf | Linen



**A** | **S5045GI-L**  
Gilded Iron | Linen



**C** | **NW5112VS**  
Venetian Silver



**B** | **NW5111VS**  
Venetian Silver



**B** | **NW5111VG**  
Venetian Gold



**C** | **NW5112VS**  
Venetian Silver



**C** | **NW5112VG**  
Venetian Gold

opposite page

**A** | **BRACELET SMALL LANTERN**  
BARRY GORALNICK

**S5045**  
H: 12" | W: 8" | Canopy: 6" Round  
Socket: E26 Keyless | Bulb: 60 B  
Shade: 6" x 6" x 11"  
**Additional Options:**  
Aged Iron | Linen Shade (AI-L)



**D** | **NW5110VS**  
Venetian Silver



**D** | **NW5110VG**  
Venetian Gold

**B** | **BRITTANY MEDIUM LANTERN**  
NIERMANN WEEKS

**NW5111**  
H: 27.25" | W: 18" | Canopy: 5" Round  
Socket: 3 - E12 Candelabra | Bulb: 3 - 60 C

**C** | **BRITTANY LARGE LANTERN**  
NIERMANN WEEKS

**NW5112**  
H: 32" | W: 24" | Canopy: 6" Round  
Socket: 6 - E12 Candelabra | Bulb: 6 - 60 C

**D** | **BRITTANY SMALL LANTERN**  
NIERMANN WEEKS

**NW5110**  
H: 17" | W: 20" | Canopy: 6" Round  
Socket: 4 - E12 Candelabra | Bulb: 4 - 40 C

**A** **INGRID CHANDELIER**  
JULIE NEILL  
  
**JN5046**  
H: 19" | W: 24.25" | Canopy: 5.5" Round  
Socket: 6 - E12 Candelabra | Bulb: 6 - 60 B



**A** **JN5046WHT/G**  
Matte White | Gild

**A** **JN5046BSL/G**  
Burnished Silver Leaf | Gild

**A** **JN5046G/BSL**  
Gild | Burnished Silver Leaf

**B** **INGRID TALL CHANDELIER**  
JULIE NEILL  
  
**JN5045**  
H: 26" | W: 15" | Canopy: 5.5" Round  
Socket: 4 - E12 Candelabra | Bulb: 4 - 40 B



**B** **JN5045WHT/G**  
Matte White | Gild

**B** **JN5045BSL/G**  
Burnished Silver Leaf | Gild

**B** **JN5045G/BSL**  
Gild | Burnished Silver Leaf

**C** **MARQUISE WIDE LANTERN**  
E. F. CHAPMAN  
  
**CHC2535**  
Fixture: 26.5" H | W: 23.25" | Canopy: 5.5" Round  
Socket: 6 - E12 Candelabra | Bulb: 6 - 60 B  
©EFC DESIGNS



**C** **CHC2535BSL**  
Burnished Silver Leaf

**C** **CHC2535GI**  
Gilded Iron

**C** **CHC2535AI**  
Aged Iron

**D** **MARQUISE TALL LANTERN**  
E. F. CHAPMAN  
  
**CHC2536**  
Fixture: 38.75" H | W: 21" | Canopy: 5.5" Round  
Socket: 6 - E12 Candelabra | Bulb: 6 - 60 B  
©EFC DESIGNS



**D** **CHC2536BSL**  
Burnished Silver Leaf

**D** **CHC2536GI**  
Gilded Iron

**D** **CHC2536AI**  
Aged Iron

**A** **NINA WOODEN LANTERN**  
SUZANNE KASLER  
  
**SK5513**  
H: 36.25" | W: 18.5" | Canopy: 5" Round  
Socket: 3 - E12 Candelabra | Bulb: 3 - 60 C



**A** **SK5513BG**  
Belgian Gild



**A** **SK5513BG**  
Belgian Gild

**B** **ZENO MEDIUM 18 FACET HEDRON LANTERN**  
E. F. CHAPMAN  
  
**CHC5201**  
H: 20" | W: 16" | Canopy: 5.5" Hexagon  
Socket: 4 - E12 Candelabra | Bulb: 4 - 60 C  
©EFC DESIGNS



**B** **CHC5201BSL-AM**  
Burnished Silver Leaf | Antique Mirror

**B** **CHC5201GI-AM**  
Gilded Iron | Antique Mirror

**B** **CHC5201AI-AM**  
Aged Iron | Antique Mirror

**C** **CHATSWORTH LANTERN**  
NIERMANN WEEKS  
  
**NW5100**  
Fixture: 27" H | W: 17.25" | Canopy: 5.5" Round  
Socket: 6 - E12 Candelabra | Bulb: 6 - 60 C



**C** **NW5100BSL**  
Burnished Silver Leaf | Clear Glass

**C** **NW5100GI**  
Gilded Iron | Clear Glass

**C** **NW5100AI**  
Aged Iron | Clear Glass





**A** SK5008PN-CG  
Polished Nickel | Clear Glass

**A** SK5008GI-CG  
Gilded Iron | Clear Glass

**A** SK5008PN-FG  
Polished Nickel | Frosted Glass

**A** SK5008GI-FG  
Gilded Iron | Frosted Glass

**A MORRIS SMALL LANTERN**  
SUZANNE KASLER

**SK5008**  
H: 21.5" | W: 13.5" | Canopy: 4.75" Round  
Socket: 3 - E12 Candelabra | Bulb: 3 - 60 C  
**Additional Options:**  
Antique Zinc | Clear Glass (AZ-CG)  
Antique Zinc | Frosted Glass (AZ-FG)

**B MORRIS MEDIUM LANTERN**  
SUZANNE KASLER

**SK5009**  
H: 26" | W: 18.5" | Canopy: 4.75" Round  
Socket: 3 - E12 Candelabra | Bulb: 3 - 60 C  
**Additional Options:**  
Gilded Iron | Clear Glass (GI-CG)  
Gilded Iron | Frosted Glass (GI-FG)

**C MORRIS LARGE LANTERN**  
SUZANNE KASLER

**SK5010**  
H: 30.25" | W: 23.25" | Canopy: 4.75" Round  
Socket: 3 - E12 Candelabra | Bulb: 3 - 60 C  
**Additional Options:**  
Antique Zinc | Frosted Glass (AZ-FG)  
Gilded Iron | Clear Glass (GI-CG)  
Gilded Iron | Frosted Glass (GI-FG)  
Polished Nickel | Clear Glass (PN-CG)  
Polished Nickel | Frosted Glass (PN-FG)



**B** SK5009PN-CG  
Polished Nickel | Clear Glass

**B** SK5009AZ-CG  
Antique Zinc | Clear Glass

**B** SK5009PN-FG  
Polished Nickel | Frosted Glass

**B** SK5009AZ-FG  
Antique Zinc | Frosted Glass

**C** SK5010AZ-CG  
Antique Zinc | Clear Glass





**A** | **CHC5211BSL-AM**  
Burnished Silver Leaf | Antique Mirror



**A** | **CHC5211AI-AM**  
Aged Iron | Antique Mirror



**C** | **CHC5213GI-AM**  
Gilded Iron | Antique Mirror

**A** | **CHC5211GI-AM**  
Gilded Iron | Antique Mirror

**B** | **CHC5212GI-AM**  
Gilded Iron | Antique Mirror

**A** | **MORAVIAN MEDIUM STAR LANTERN**  
E. F. CHAPMAN

**CHC5211**  
H: 19.75" | W: 18" | Canopy: 6" Round  
Socket: E26 Keyless | Bulb: 75 A  
©EFC DESIGNS

**B** | **MORAVIAN LARGE STAR LANTERN**  
E. F. CHAPMAN

**CHC5212**  
H: 32.75" | W: 30" | Canopy: 6" Round  
Socket: E26 Keyless | Bulb: 100 A  
©EFC DESIGNS

**C** | **MORAVIAN GRANDE STAR LANTERN**  
E. F. CHAPMAN

**CHC5213**  
H: 52.25" | W: 48" | Canopy: 6" Round  
Socket: 3 - E26 Keyless | Bulb: 3 - 60 A  
©EFC DESIGNS



**B** | **CHC5212BSL-AM**  
Burnished Silver Leaf | Antique Mirror



**B** | **CHC5212GI-AM**  
Gilded Iron | Antique Mirror



**B** | **CHC5212AI-AM**  
Aged Iron | Antique Mirror



**C** | **CHC5213BSL-AM**  
Burnished Silver Leaf | Antique Mirror



**C** | **CHC5213AI-AM**  
Aged Iron | Antique Mirror



**B** | ARN5002G  
Gild

**A** | MILL SMALL GLOBE LANTERN  
AERIN

ARN5003  
H: 18.5" | W: 16" | Canopy: 6" Round  
Socket: 4 - E12 Candelabra | Bulb: 4 - 60 C



**A** | ARN5003PW  
Plaster White



**A** | ARN5003BSL  
Burnished Silver Leaf



**A** | ARN5003G  
Gild



**A** | ARN5003AI  
Aged Iron

**B** | MILL LARGE GLOBE LANTERN  
AERIN

ARN5002  
H: 32.25" | W: 30" | Canopy: 6" Round  
Socket: 6 - E12 Candelabra | Bulb: 6 - 60 C



**B** | ARN5002PW  
Plaster White



**B** | ARN5002BSL  
Burnished Silver Leaf



**B** | ARN5002G  
Gild



**B** | ARN5002AI  
Aged Iron

**A METAL BANDED MEDIUM LANTERN**  
E. F. CHAPMAN

**CHC2530**  
H: 65.25" | Fixture: 23.5" H | W: 20.75"  
Canopy: 5.5" Hexagon  
Socket: E26 Keyless | Bulb: 75 A  
\* Custom Height Available (34" Minimum)  
©EFC DESIGNS

**B METAL BANDED LARGE LANTERN**  
E. F. CHAPMAN

**CHC2531**  
H: 83.25" | Fixture: 32.75" H | W: 29.75"  
Canopy: 5.5" Hexagon  
Socket: E26 Keyless | Bulb: 100 A  
\* Custom Height Available (38" Minimum)  
©EFC DESIGNS

**B CHC2531GI**  
Gilded Iron | Frosted Glass



**A CHC2530GI**  
Gilded Iron | Frosted Glass

**A CHC2530AI**  
Aged Iron | Frosted Glass

**B CHC2531GI**  
Gilded Iron | Frosted Glass

**B CHC2531AI**  
Aged Iron | Frosted Glass

**A ZODIAC LANTERN**  
E. F. CHAPMAN

**CHC2112**  
H: 46.5" | Fixture: 27" H | W: 23.5"  
Canopy: 6" Round  
Socket: 2 - E26 Keyless | Bulb: 2 - 100 A  
©EFC DESIGNS

opposite page

**B ARMILLARY SPHERE CHANDELIER**  
ERIC COHLER

**SC5102**  
H: 24.75" | W: 34.75" | Canopy: 5.5" Round  
Socket: 6 - E12 Candelabra | Bulb: 6 - 60 C

**C MODERN GLOBE MEDIUM LANTERN**  
E. F. CHAPMAN

**CHC2135**  
H: 39.25" | W: 24.25" | Canopy: 5.5" Round  
Socket: 2 - E26 Keyless | Bulb: 2 - 75 A  
\* Custom Height Available (34.25" Minimum)  
©EFC DESIGNS



**A CHC2112BZV-WG**  
Bronze Verdigris | White Glass



**A CHC2112AB-WG**  
Antique-Burnished Brass | White Glass



**B SC5102PN**  
Polished Nickel



**B SC5102HAB**  
Hand-Rubbed Antique Brass



**B SC5102BZ**  
Bronze



**C CHC2135PN-WG**  
Polished Nickel | White Glass



**C CHC2135AB-WG**  
Antique-Burnished Brass | White Glass



**C CHC2135BZ-WG**  
Bronze | White Glass



**A** MS5030ABV-WG  
Antique Brass Verdigris | White Glass

**A** MODERN SCHOOLHOUSE LANTERN  
MICHAEL S SMITH

**MS5030**  
H: 40" | W: 18" | Canopy: 7.5" Round  
Socket: 2 - E26 Keyless | Bulb: 2 - 75 A

opposite page

**B** CROWN TOP BANDED GLOBE LANTERN  
E. F. CHAPMAN

**CHC2111**  
H: 21" | W: 15" | Canopy: 5.5" Round  
Socket: 3 - E12 Candelabra | Bulb: 3 - 60 C  
©EFC DESIGNS

**C** ALDERLY GLOBE LANTERN  
E. F. CHAPMAN

**CHC2128**  
H: 21.25" | W: 15.5" | Canopy: 5.5" Round  
Socket: 3 - E12 Candelabra | Bulb: 3 - 60 C  
©EFC DESIGNS

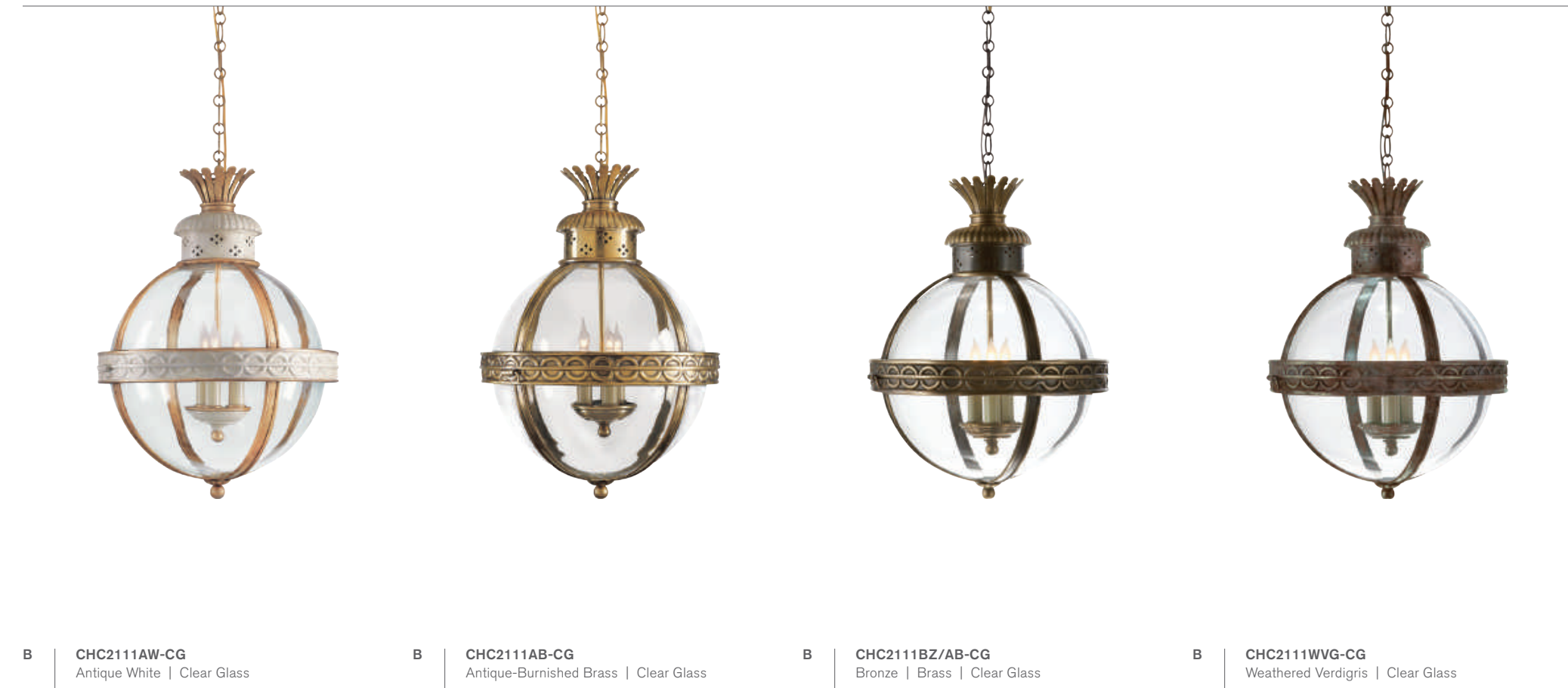

**B** CHC2111AW-CG  
Antique White | Clear Glass

**B** CHC2111AB-CG  
Antique-Burnished Brass | Clear Glass

**B** CHC2111BZ/AB-CG  
Bronze | Brass | Clear Glass

**B** CHC2111WVG-CG  
Weathered Verdigris | Clear Glass

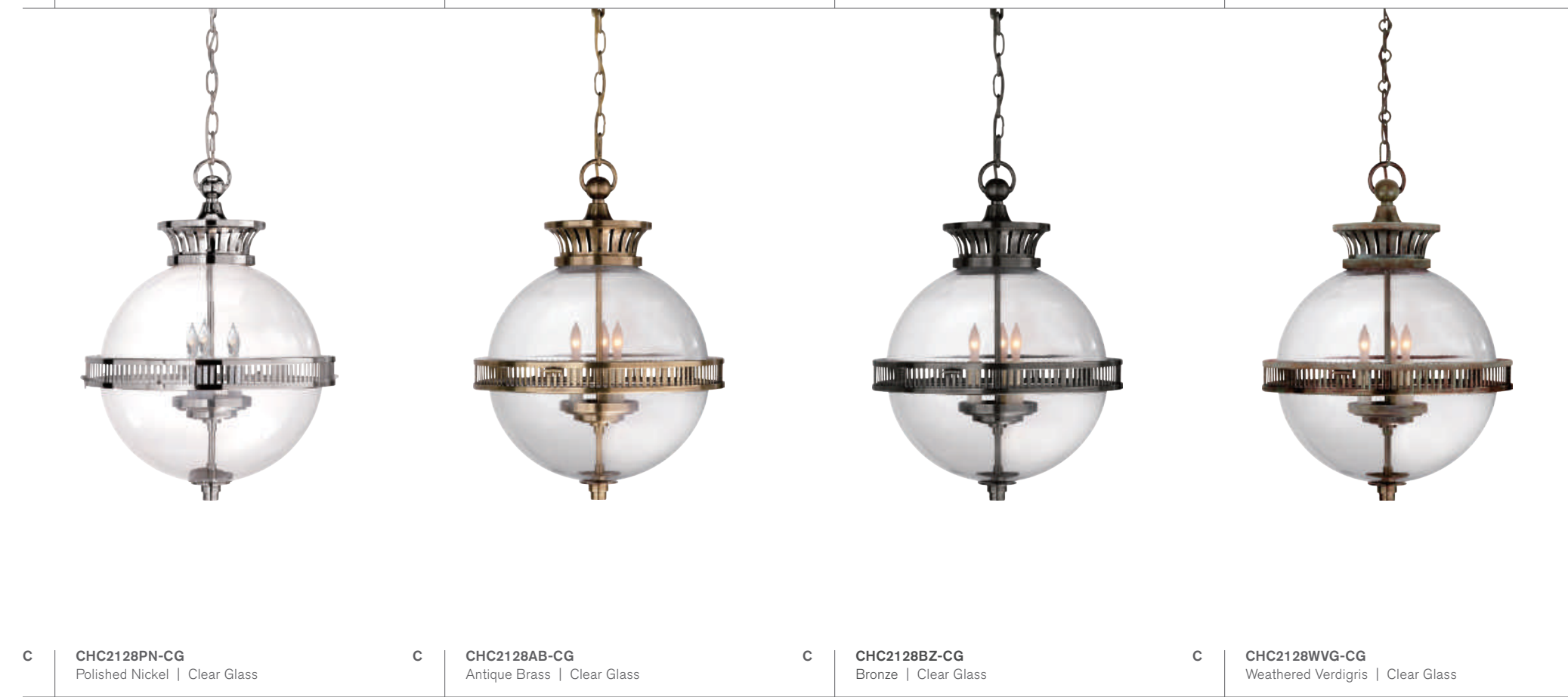

**C** CHC2128PN-CG  
Polished Nickel | Clear Glass

**C** CHC2128AB-CG  
Antique Brass | Clear Glass

**C** CHC2128BZ-CG  
Bronze | Clear Glass

**C** CHC2128WVG-CG  
Weathered Verdigris | Clear Glass



**A** **TOB5030PN**  
Polished Nickel | Clear Glass

**A** **TOB5030HAB**  
Hand-Rubbed Antique Brass | Clear Glass

**A** **TOB5030BZ**  
Bronze | Clear Glass



**B** **CHC2117PN**  
Polished Nickel

**B** **CHC2117AB**  
Antique-Burnished Brass

**C** **CHC2110BZ**  
Bronze

**A** **MERCHANT LANTERN**  
THOMAS O'BRIEN  
  
**TOB5030**  
H: 18" | W: 11.75" | Canopy: 5.25" Round  
Socket: 3 - E12 Candelabra | Bulb: 3 - 60 C  
**Additional Options:**  
Antique Nickel | Clear Glass (AN)

**B** **COUNTRY MEDIUM BELL JAR LANTERN**  
E. F. CHAPMAN  
  
**CHC2117**  
H: 21" | W: 15.5" | Canopy: 6" Round  
Socket: 6 - E12 Candelabra | Bulb: 6 - 60 C  
**Additional Options:**  
Antique Nickel (AN)  
Bronze (BZ)  
©EFC DESIGNS

**C** **COUNTRY LARGE BELL JAR LANTERN**  
E. F. CHAPMAN  
  
**CHC2110**  
H: 25.75" | W: 21" | Canopy: 6" Round  
Socket: 6 - E12 Candelabra | Bulb: 6 - 60 C  
**Additional Options:**  
Antique-Burnished Brass (AB)  
Antique Nickel (AN)  
Polished Nickel (PN)  
©EFC DESIGNS

opposite page

**D** **PONDVIEW MEDIUM JAR LANTERN**  
AERIN  
  
**ARN5200**  
H: 37.5" | W: 19.5" | Canopy: 6.25" Round  
Socket: 3 - E12 Candelabra | Bulb: 3 - 60 C



**B** **CHC2117AB**  
Antique-Burnished Brass



**D** **ARN5200BSL**  
Burnished Silver Leaf



**D** **ARN5200HAB**  
Hand-Rubbed Antique Brass



**C** | **CHC2270AI-MG**  
Aged Iron | Mercury Glass

**A** | **LORFORD TALL SMOKE BELL LANTERN**  
E. F. CHAPMAN

**CHC2298**  
H: 23.25" | W: 9.75" | Canopy: 5.5" Round  
Socket: 3 - E12 Candelabra | Bulb: 3 - 40 C  
©EFC DESIGNS

**B** | **LORFORD SMALL SMOKE BELL LANTERN**  
E. F. CHAPMAN

**CHC2269**  
Fixture: 23.75" H | W: 14" | Canopy: 5.5" Round  
Socket: 4 - E12 Candelabra | Bulb: 4 - 60 C  
©EFC DESIGNS

**C** | **LORFORD SMOKE BELL LANTERN**  
E. F. CHAPMAN

**CHC2270**  
Fixture: 33.75" H | W: 20" | Canopy: 5.5" Round  
Socket: 4 - E12 Candelabra | Bulb: 4 - 60 C  
©EFC DESIGNS

**D** | **LORFORD LARGE SMOKE BELL LANTERN**  
E. F. CHAPMAN

**CHC2271**  
Fixture: 42.5" H | W: 25" | Canopy: 5.5" Round  
Socket: 4 - E12 Candelabra | Bulb: 4 - 60 C  
©EFC DESIGNS



**A** | **CHC2298GI-MG**  
Gilded Iron | Mercury Glass

**A** | **CHC2298AI-MG**  
Aged Iron | Mercury Glass

**B** | **CHC2269GI-MG**  
Gilded Iron | Vintage Mercury Glass

**B** | **CHC2269AI-MG**  
Aged Iron | Vintage Mercury Glass



**C** | **CHC2270GI-MG**  
Gilded Iron | Vintage Mercury Glass

**C** | **CHC2270AI-MG**  
Aged Iron | Vintage Mercury Glass

**D** | **CHC2271GI-MG**  
Gilded Iron | Vintage Mercury Glass

**D** | **CHC2271AI-MG**  
Aged Iron | Vintage Mercury Glass





CEILING | FLUSH MOUNTS



**A** | **KW4093AB/Q**  
Antique-Burnished Brass | Quartz



**B** | **KW4092AB/Q**  
Antique-Burnished Brass | Quartz



**C** | **S7010HAB-CA**  
Hand-Rubbed Antique Brass | Clear Acrylic



**D** | **KW4011AB-ALB**  
Antique-Burnished Brass | Alabaster

opposite page

**A** | **HALCYON SOLITAIRE FLUSH MOUNT**  
KELLY WEARSTLER

**KW4093**  
H: 1.5" | W: 5"  
LED: 12w

**B** | **HALCYON TALL SOLITAIRE FLUSH MOUNT**  
KELLY WEARSTLER

**KW4092**  
H: 3.75" | W: 5"  
LED: 12w

**C** | **BRECK PETITE FLUSH MOUNT**  
STUDIO VC

**S7010**  
H: 4" | W: 5"  
LED: 11w  
**Additional Options:**  
Antique Nickel | Clear Acrylic (AN-CA)  
Bronze | Clear Acrylic (BZ-CA)  
Polished Nickel | Clear Acrylic (PN-CA)

**D** | **MELANGE PETITE FLUSH MOUNT**  
KELLY WEARSTLER

**KW4011**  
H: 3.5" | W: 5"  
LED: 12w  
**Additional Options:**  
Polished Nickel | Alabaster (PN-ALB)

**E** | **MELANGE SMALL FLUSH MOUNT**  
KELLY WEARSTLER

**KW4012**  
H: 4.5" | W: 14"  
Socket: 2 - E26 Keyless | Bulb: 2 - 14.5 LED A  
**Additional Options:**  
Polished Nickel | Alabaster (PN)

**F** | **MELANGE LARGE FLUSH MOUNT**  
KELLY WEARSTLER

**KW4013**  
H: 5" | W: 17"  
Socket: 2 - E26 Keyless | Bulb: 2 - 14.5 LED A



**D** | **KW4011AB-ALB**  
Antique-Burnished Brass | Alabaster

**D** | **KW4011BZ-ALB**  
Bronze | Alabaster



**E** | **KW4012AB**  
Antique-Burnished Brass | Alabaster

**E** | **KW4012BZ**  
Bronze | Alabaster

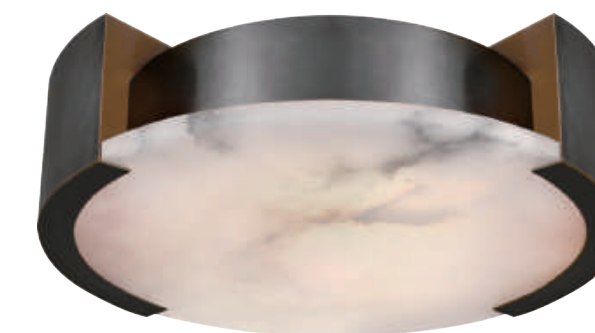

**F** | **KW4013AB**  
Antique-Burnished Brass | Alabaster

**F** | **KW4013BZ**  
Bronze | Alabaster

**A COVET PETITE FLUSH MOUNT**  
 KELLY WEARSTLER  
**KW4112**  
 H: 4.5" | W: 4.75" | Canopy: 4.5" Square  
 LED: 13w



**A** | **KW4112PN-ALB**  
 Polished Nickel | Alabaster

**A** | **KW4112AB-ALB**  
 Antique-Burnished Brass | Alabaster

**A** | **KW4112BZ-ALB**  
 Bronze | Alabaster

**B COVET SMALL FLUSH MOUNT**  
 KELLY WEARSTLER  
**KW4114**  
 H: 2.25" | W: 8.25" | Canopy: 7.25" Square  
 LED: 31w



**B** | **KW4114PN-ALB**  
 Polished Nickel | Alabaster

**B** | **KW4114AB-ALB**  
 Antique-Burnished Brass | Alabaster

**B** | **KW4114BZ-ALB**  
 Bronze | Alabaster

**C COVET MEDIUM FLUSH MOUNT**  
 KELLY WEARSTLER  
**KW4113**  
 H: 2.75" | W: 14.25" | Canopy: 13.25" Square  
 LED: 46w  
**Additional Options:**  
 Polished Nickel | Alabaster (PN-ALB)



**C** | **KW4113AB-ALB**  
 Antique-Burnished Brass | Alabaster

**C** | **KW4113BZ-ALB**  
 Bronze | Alabaster



**D PRECISION SOLITAIRE FLUSH MOUNT**  
 KELLY WEARSTLER  
**KW4055**  
 H: 2.5" | W: 4.5"  
 LED: 12w

**D** | **KW4055PN-CDG**  
 Polished Nickel | Clouded Glass

**D** | **KW4055AB-CDG**  
 Antique-Burnished Brass | Clouded Glass

**D** | **KW4055BZ-CDG**  
 Bronze | Clouded Glass



**E PRECISION SMALL FLUSH MOUNT**  
 KELLY WEARSTLER  
**KW4060**  
 H: 4.5" | W: 6" | Canopy: 4" Square  
 Socket: GU10 | Bulb: 35 J

**E** | **KW4060PN-CDG**  
 Polished Nickel | Clouded Glass

**E** | **KW4060AB-CDG**  
 Antique-Burnished Brass | Clouded Glass

**E** | **KW4060BZ-CDG**  
 Bronze | Clouded Glass



**F PRECISION LARGE FLUSH MOUNT**  
 KELLY WEARSTLER  
**KW4061**  
 H: 3.5" | W: 12.5" | Canopy: 9.5" Square  
 Socket: 2 - E12 Candelabra | Bulb: 2 - 40 B  
**Additional Options:**  
 Polished Nickel | Clouded Glass (PN-CDG)

**F** | **KW4061AB-CDG**  
 Antique-Burnished Brass | Clouded Glass

**F** | **KW4061BZ-CDG**  
 Bronze | Clouded Glass



**A** | **KW4030G-FRG**  
Gild | Fractured Glass Trim



**A** | **KW4030AI-FRG**  
Aged Iron | Fractured Glass Trim



**B** | **KW4050G-FR**  
Gild | Fractured Glass



**B** | **KW4050AI-FR**  
Aged Iron | Fractured Glass



**C** | **KW4032G-FRG**  
Gild | Fractured Glass



**C** | **KW4032AI-FRG**  
Aged Iron | Fractured Glass

**A** | **UTOPIA PETITE ROUND FLUSH MOUNT**  
KELLY WEARSTLER

**KW4030**  
H: 2" | W: 5"  
LED: 12w

**B** | **UTOPIA SMALL ROUND FLUSH MOUNT**  
KELLY WEARSTLER

**KW4050**  
H: 4.25" | W: 14"  
Socket: 2 - E26 Keyless | Bulb: 2 - 60 A

**C** | **UTOPIA MEDIUM ROUND FLUSH MOUNT**  
KELLY WEARSTLER

**KW4032**  
H: 4.5" | W: 18"  
Socket: 3 - E26 Keyless | Bulb: 3 - 60 B

opposite page

**D** | **NOUVEL MEDIUM FLUSH MOUNT**  
KELLY WEARSTLER

**KW4280**  
H: 5.25" | W: 20" | Canopy: 5.75" Round  
LED: 24w

**E** | **UTOPIA MEDIUM 5 ARM CHANDELIER**  
KELLY WEARSTLER

**KW5036**  
H: 40.5" | Fixture: 5" H | W: 32.75"  
Canopy: 8" Round  
Socket: 5 - E26 Keyless | Bulb: 5 - 60 B  
\* Custom Height Available (15" Minimum)



**D** | **KW4280PN-WG**  
Polished Nickel | White Glass



**D** | **KW4280AB-WG**  
Antique-Burnished Brass | White Glass



**D** | **KW4280BZ/AB-WG**  
Bronze | Antique-Burnished Brass | White Glass



**E** | **KW5036PN-WG**  
Polished Nickel | White Glass



**E** | **KW5036G-WG**  
Gild | White Glass



**E** | **KW5036AI-WG**  
Aged Iron | White Glass



**A** **TOB4291PN-L**  
Polished Nickel | Linen



**A** **TOB4291HAB-L**  
Hand-Rubbed Antique Brass | Linen



**A** **TOB4291BZ/HAB-L**  
Bronze | Hand-Rubbed Antique Brass | Linen

opposite page

**A** **OSIRIS LARGE ASYMMETRIC SEMI-FLUSH MOUNT**  
THOMAS O'BRIEN

**TOB4291**  
H: 9.5" | W: 47" | Canopy: 5" Round  
Socket: 3 - E26 Keyless | Bulb: 3 - 40 A



**B** **TOB4290PN-L**  
Polished Nickel | Linen



**C** **TOB4294PN-L**  
Polished Nickel | Linen



**B** **TOB4290HAB-L**  
Hand-Rubbed Antique Brass | Linen



**C** **TOB4294HAB-L**  
Hand-Rubbed Antique Brass | Linen



**B** **TOB4290BZ/HAB-L**  
Bronze | Hand-Rubbed Antique Brass | Linen



**C** **TOB4294BZ/HAB-L**  
Bronze | Hand-Rubbed Antique Brass | Linen

**B** **OSIRIS MEDIUM REFLECTOR SEMI-FLUSH MOUNT**  
THOMAS O'BRIEN

**TOB4290**  
H: 9" | W: 25" | Canopy: 5.75" Round  
Socket: 3 - E26 Keyless | Bulb: 3 - 40 A

**C** **OSIRIS MEDIUM FLUSH MOUNT**  
THOMAS O'BRIEN

**TOB4294**  
H: 5.75" | W: 15.25" | Canopy: 4.5" Round  
Socket: 2 - E26 Keyless | Bulb: 2 - 40 A



**A STRADA SMALL FLUSH MOUNT**  
 KELLY WEARSTLER

**KW4065**  
 H: 8" | W: 18.75"  
 Socket: 6 - E12 Candelabra | Bulb: 6 - 40 C  
**Additional Options:**  
 Burnished Silver Leaf (BSL)

**B STRADA MEDIUM FLUSH MOUNT**  
 KELLY WEARSTLER

**KW4070**  
 H: 11" | W: 28"  
 Socket: 10 - E12 Candelabra | Bulb: 10 - 40 C  
**Additional Options:**  
 Polished Nickel (PN)

**C STRADA LARGE FLUSH MOUNT**  
 KELLY WEARSTLER

**KW4071**  
 H: 14.5" | W: 40"  
 Socket: 10 - E12 Candelabra | Bulb: 10 - 60 C  
**Additional Options:**  
 Burnished Silver Leaf (BSL)

**C KW4071AI**  
 Aged Iron

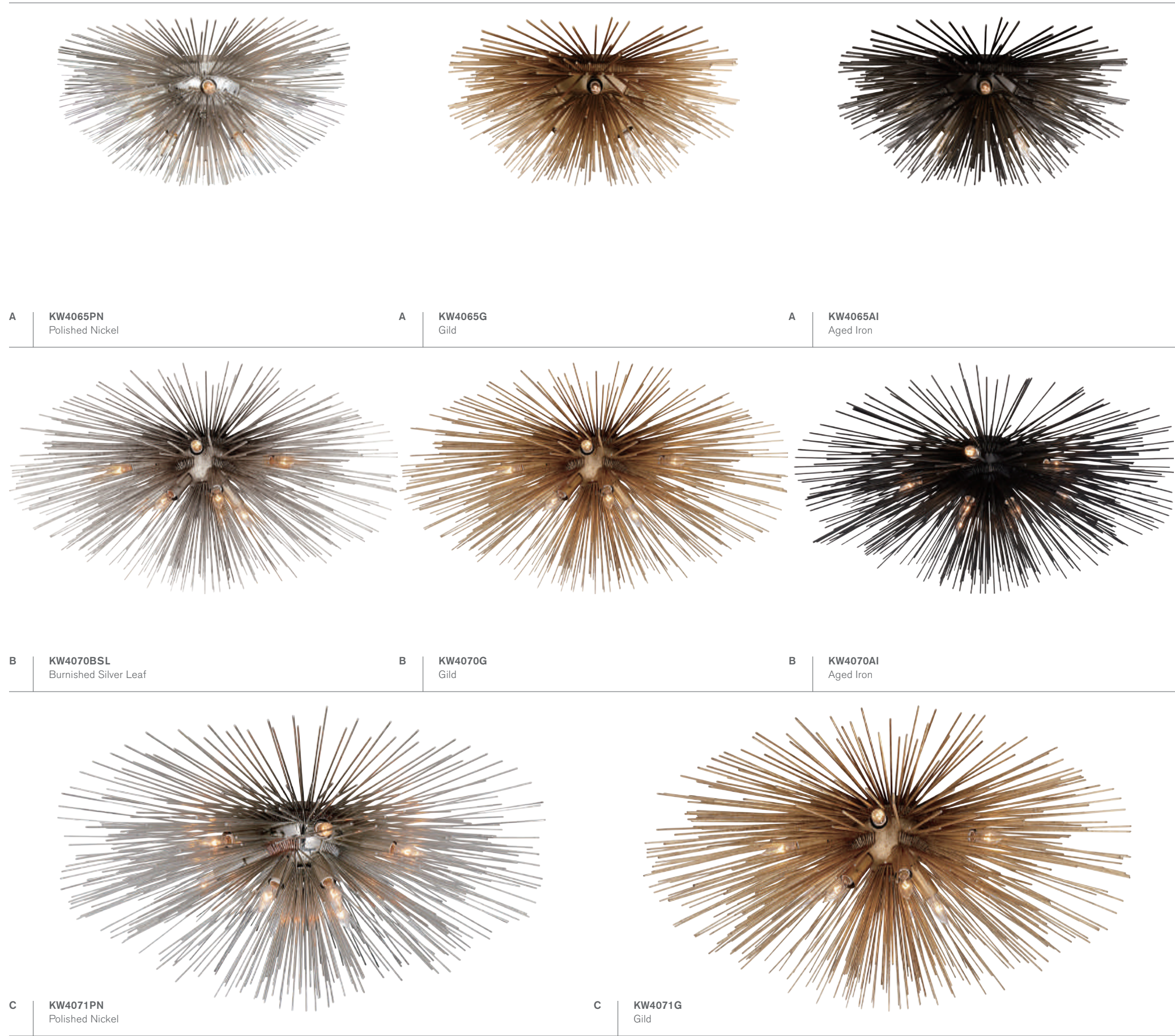

**A KW4065PN**  
 Polished Nickel

**A KW4065G**  
 Gild

**A KW4065AI**  
 Aged Iron

**B KW4070BSL**  
 Burnished Silver Leaf

**B KW4070G**  
 Gild

**B KW4070AI**  
 Aged Iron

**C KW4071PN**  
 Polished Nickel

**C KW4071G**  
 Gild



**A** | **SK5200PN**  
Polished Nickel | Frosted Glass

**A** | **SK5200HAB**  
Hand-Rubbed Antique Brass | Frosted Glass

**A** | **SK5200BZ**  
Bronze | Frosted Glass



**B** | **SK5201PN**  
Polished Nickel | Frosted Glass

**B** | **SK5201HAB**  
Hand-Rubbed Antique Brass | Frosted Glass

**B** | **SK5201BZ**  
Bronze | Frosted Glass



**C** | **SK5202PN**  
Polished Nickel | Frosted Glass

**C** | **SK5202HAB**  
Hand-Rubbed Antique Brass | Frosted Glass

opposite page

**A** | **SOLEIL SMALL SEMI-FLUSH**  
SUZANNE KASLER

**SK5200**  
H: 14" | W: 16" | Canopy: 5.25" Round  
Socket: E26 Keyless | Bulb: 60 A  
\* Custom Height Available (10.5" Minimum)

**B** | **SOLEIL MEDIUM SEMI-FLUSH**  
SUZANNE KASLER

**SK5201**  
H: 15" | W: 24" | Canopy: 5.25" Round  
Socket: E26 Keyless | Bulb: 60 A  
\* Custom Height Available (11" Minimum)

**C** | **SOLEIL LARGE SEMI-FLUSH**  
SUZANNE KASLER

**SK5202**  
H: 14.5" | W: 28" | Canopy: 5.25" Round  
Socket: 2 - E26 Keyless | Bulb: 2 - 60 A  
\* Custom Height Available (12" Minimum)  
**Additional Options:**  
Bronze | Frosted Glass (BZ)

**D** | **RÉ FLUSH MOUNT**  
SUZANNE KASLER

**SK4000**  
H: 6" | W: 22" | Canopy: 5" Round  
Socket: 2 - E12 Candelabra | Bulb: 2 - 60 B  
\* Ceiling or Wall Mount



**D** | **SK4000GI**  
Gilded Iron



**A STAR FLUSH MOUNT**  
ERIC COHLER

**SC4000**  
H: 2.5" | W: 14.5"  
Socket: E26 Keyless | Bulb: 60 A  
**Additional Options:**  
Antique Silver (AS)



**A SC4000PN**  
Polished Nickel

**A SC4000HAB**  
Hand-Rubbed Antique Brass

**A SC4000BZ**  
Bronze

**B CONSTELLATION SMALL FLUSH MOUNT**  
STUDIO VC

**SE4100**  
H: 7.75" | W: 19.75" | Canopy: 5" Round  
Socket: 3 - E12 Candelabra | Bulb: 3 - 60 C

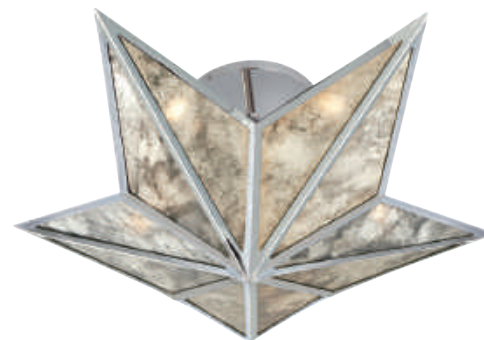

**B SE4100PN**  
Polished Nickel | Antique Mirror

**B SE4100HAB**  
Hand-Rubbed Antique Brass | Antique Mirror

**B SE4100BZ**  
Bronze | Antique Mirror

**C CLAYMORE MEDIUM FLUSH MOUNT**  
E. F. CHAPMAN

**CHC4402**  
H: 4.25" | W: 27.5"  
LED: 15w  
©EFC DESIGNS



**C CHC4402BSL**  
Burnished Silver Leaf

**C CHC4402GI**  
Gilded Iron

**C CHC4402GI**  
Gilded Iron





**A** AH4016PN/CG-FG  
Polished Nickel | Glass Rods | Frosted Glass



**A** AH4016NB/CG-FG  
Natural Brass | Glass Rods | Frosted Glass



**A** AH4016GM/CG-FG  
Gun Metal | Glass Rods | Frosted Glass



**B** AH4017PN/CG-FG  
Polished Nickel | Glass Rods | Frosted Glass



**B** AH4017NB/CG-FG  
Natural Brass | Glass Rods | Frosted Glass



**B** AH4017GM/CG-FG  
Gun Metal | Glass Rods | Frosted Glass



**B** AH4017PN-FG  
Polished Nickel | Frosted Glass



**B** AH4017NB-FG  
Natural Brass | Frosted Glass

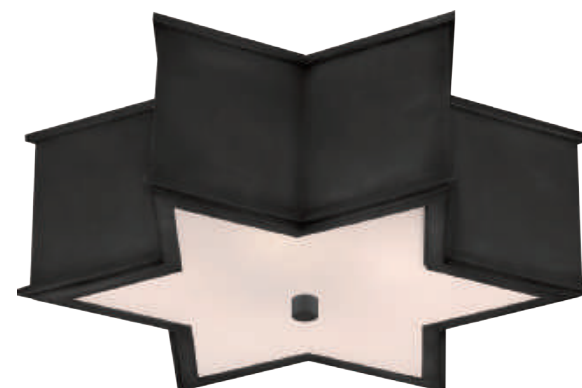

**B** AH4017GM-FG  
Gun Metal | Frosted Glass



**B** AH4016PN-FG  
Polished Nickel | Frosted Glass



**C** AH4018PN/CG-FG  
Polished Nickel | Glass Rods | Frosted Glass

opposite page

**A** SOPHIA SMALL FLUSH MOUNT  
ALEXA HAMPTON

**AH4016**  
H: 5" | W: 13.5"  
Socket: 2 - E12 Candelabra | Bulb: 2 - 40 B  
**Additional Options:**  
Natural Brass | Frosted Glass (NB-FG)  
Gun Metal | Frosted Glass (GM-FG)

**B** SOPHIA LARGE FLUSH MOUNT  
ALEXA HAMPTON

**AH4017**  
H: 5" | W: 17"  
Socket: 3 - E12 Candelabra | Bulb: 3 - 40 B

**C** LANA SMALL FLUSH MOUNT  
ALEXA HAMPTON

**AH4018**  
H: 5.25" | W: 15"  
Socket: 2 - E12 Candelabra | Bulb: 2 - 40 B  
**Additional Options:**  
Natural Brass | Glass Rods | Frosted Glass (NB/CG-FG)  
Gun Metal | Glass Rods | Frosted Glass (GM/CG-FG)



A AH4014PN-FG  
Polished Nickel | Frosted Glass



A AH4014GM-FG  
Gun Metal | Frosted Glass

A **BASIL SMALL FLUSH MOUNT**  
ALEXA HAMPTON  
  
AH4014  
H: 5" | W: 11.25"  
Socket: 2 - E12 Candelabra | Bulb: 2 - 40 B

B **BASIL LARGE FLUSH MOUNT**  
ALEXA HAMPTON  
  
AH4015  
H: 5" | W: 17"  
Socket: 3 - E26 Keyless | Bulb: 3 - 60 B



A AH4014NB-FG  
Natural Brass | Frosted Glass



A AH4014PN/CG-FG  
Polished Nickel | Glass Rods | Frosted Glass



A AH4014NB/CG-FG  
Natural Brass | Glass Rods | Frosted Glass



A AH4014GM/CG-FG  
Gun Metal | Glass Rods | Frosted Glass



B AH4015PN/CG-FG  
Polished Nickel | Glass Rods | Frosted Glass



B AH4015NB/CG-FG  
Natural Brass | Glass Rods | Frosted Glass



B AH4015GM/CG-FG  
Gun Metal | Glass Rods | Frosted Glass



B AH4015PN-FG  
Polished Nickel | Frosted Glass



B AH4015NB-FG  
Natural Brass | Frosted Glass



B AH4015GM-FG  
Gun Metal | Frosted Glass



**A** | **ARN4041WHT**  
White | Frosted Glass

**A** | **ARN4041BSL**  
Burnished Silver Leaf | Frosted Glass

**A** | **ARN4041G**  
Gild | Frosted Glass



**B** | **ARN4047WHT**  
White | Frosted Glass

**B** | **ARN4047BSL**  
Burnished Silver Leaf | Frosted Glass

**B** | **ARN4047G**  
Gild | Frosted Glass



**C** | **ARN4307BSL-FG**  
Burnished Silver Leaf | Frosted Acrylic

**C** | **ARN4307G-FG**  
Gild | Frosted Acrylic



**D** | **ARN4306BSL-FG**  
Burnished Silver Leaf | Frosted Acrylic



**D** | **ARN4306G-FG**  
Gild | Frosted Acrylic

**A** | **BOLSENA CLOVER FLUSH MOUNT**  
AERIN

**ARN4041**  
H: 5.75" | W: 11.75"  
Socket: 2 - E12 Candelabra | Bulb: 2 - 60 B

**B** | **BOLSENA DECO FLUSH MOUNT**  
AERIN

**ARN4047**  
H: 5.75" | W: 11.75"  
Socket: 2 - E12 Candelabra | Bulb: 2 - 60 B

**C** | **ARABELLE LARGE FLUSH MOUNT**  
AERIN

**ARN4307**  
H: 8.25" | W: 19.5"  
Socket: 4 - E12 Candelabra | Bulb: 4 - 40 B

**D** | **ARABELLE SMALL FLUSH MOUNT**  
AERIN

**ARN4306**  
H: 7.75" | W: 13.5" | Canopy: 10.75" Round  
Socket: 3 - E12 Candelabra | Bulb: 3 - 60 C



**B** | **TOB4130PN-WG**  
Polished Nickel | White Glass

**A** | **BALTHAZAR FLUSH MOUNT**  
ALEXA HAMPTON  
  
**AH4025**  
H: 4.5" | W: 14"  
Socket: 3 - E26 Keyless | Bulb: 3 - 60 B



**A** | **AH4025PN-FG**  
Polished Nickel | Frosted Glass



**A** | **AH4025NB-FG**  
Natural Brass | Frosted Glass



**A** | **AH4025GM-FG**  
Gun Metal | Frosted Glass

**B** | **TILDEN SMALL FLUSH MOUNT**  
THOMAS O'BRIEN  
  
**TOB4130**  
H: 5" | W: 11.2 5"  
Socket: 2 - E26 Keyless | Bulb: 2 - 40 B  
**Additional Options:**  
Antique Nickel | White Glass (AN-WG)



**B** | **TOB4130PN-WG**  
Polished Nickel | White Glass



**B** | **TOB4130HAB-WG**  
Hand-Rubbed Antique Brass | White Glass



**B** | **TOB4130BZ-WG**  
Bronze | White Glass

**C** | **TILDEN LARGE FLUSH MOUNT**  
THOMAS O'BRIEN  
  
**TOB4131**  
H: 6" | W: 17"  
Socket: 4 - E26 Keyless | Bulb: 4 - 60 B  
**Additional Options:**  
Antique Nickel | White Glass (AN-WG)



**C** | **TOB4131PN-WG**  
Polished Nickel | White Glass



**C** | **TOB4131HAB-WG**  
Hand-Rubbed Antique Brass | White Glass



**C** | **TOB4131BZ-WG**  
Bronze | White Glass



**A** | **KS4117BSL/WHT-FA**  
Burnished Silver Leaf | White | Frosted Acrylic

**A** | **KS4117G/WHT-FA**  
Gild | White | Frosted Acrylic

**A** | **KS4117PNK/WHT-FA**  
Pink | White | Frosted Acrylic



**B** | **KS4118BSL/WHT-FA**  
Burnished Silver Leaf | White | Frosted Acrylic

**B** | **KS4118G/WHT-FA**  
Gild | White | Frosted Acrylic

**B** | **KS4118NVY/WHT-FA**  
French Navy | White | Frosted Acrylic



**C** | **AH4021BSL/G-FA**  
Burnished Silver Leaf | Gild | Frosted Glass

**C** | **AH4021G-FA**  
Gild | Frosted Glass



**A** | **KS4117WHT/G-FA**  
White | Gild | Frosted Acrylic

opposite page

**A** | **BRYCE MEDIUM FLUSH MOUNT**  
kate spade new york

**KS4117**  
H: 7" | W: 15"  
Socket: 2 - E26 Keyless | Bulb: 2 - 60 B  
**Additional Options:**  
French Navy | White | Frosted Acrylic (NVY-FA)

**B** | **BRYCE LARGE FLOWER FLUSH MOUNT**  
kate spade new york

**KS4118**  
H: 7" | W: 20"  
Socket: 4 - E26 Keyless | Bulb: 4 - 40 A  
**Additional Options:**  
Pink | White | Frosted Acrylic (PNK/WHT-FA)  
White | Gild | Frosted Acrylic (WHT/G-FA)

**C** | **MARKOS GRANDE FLUSH MOUNT**  
ALEXA HAMPTON

**AH4021**  
H: 12" | W: 26"  
Socket: 4 - E26 Keyless | Bulb: 4 - 60 B  
**Additional Options:**  
White | Gild | Frosted Glass (WHT/G-FA)  
\* Requires Special Assembly and Installation

**D** | **GRAYSON PETITE FLUSH MOUNT**  
kate spade new york

**KS4945**  
H: 2.5" | W: 5.25" | Canopy: 4.25" Round  
LED: 11w  
**Additional Options:**  
Burnished Silver Leaf | Frosted Acrylic (BSL-CG)



**D** | **KS4945G-CG**  
Gild | Crystal



**A** | **AH4004WHT-FG**  
Matte White | Frosted Glass



**B** | **AH4005WHT-FG**  
Matte White | Frosted Glass

**A** | **FRANK SMALL FLUSH MOUNT**  
ALEXA HAMPTON

**AH4004**  
H: 4.75" | W: 11.25"  
Socket: 2 - E26 Keyless | Bulb: 2 - 60 B

**B** | **FRANK LARGE FLUSH MOUNT**  
ALEXA HAMPTON

**AH4005**  
H: 4.75" | W: 15"  
Socket: 3 - E26 Keyless | Bulb: 3 - 60 B



**A** | **AH4004PN-FG**  
Polished Nickel | Frosted Glass



**B** | **AH4005PN-FG**  
Polished Nickel | Frosted Glass



**A** | **AH4004NB-FG**  
Natural Brass | Frosted Glass



**B** | **AH4005NB-FG**  
Natural Brass | Frosted Glass



**A** | **AH4004GM-FG**  
Gun Metal | Frosted Glass



**B** | **AH4005GM-FG**  
Gun Metal | Frosted Glass

**A LIAISON MEDIUM FLUSH MOUNT**  
 KELLY WEARSTLER

**KW4202**  
 H: 5" | W: 12"  
 Socket: 2 - E12 Candelabra | Bulb: 2 - 60 C

**Additional Options:**  
 Bronze | Crackle Glass (BZ-CRG)



**A KW4202PN-CRG**  
 Polished Nickel | Crackle Glass

**A KW4202AB-CRG**  
 Antique-Burnished Brass | Crackle Glass

**B SOPHIE FLUSH MOUNT**  
 NIERMANN WEEKS

**NW4020**  
 H: 5.5" | W: 14.25"  
 Socket: 4 - E12 Candelabra | Bulb: 4 - 60 C



**B NW4020BSL**  
 Burnished Silver Leaf | Glass Rods

**B NW4020GI**  
 Gilded Iron | Glass Rods

**C SOPHIE LARGE FLUSH MOUNT**  
 NIERMANN WEEKS

**NW4021**  
 H: 7" | W: 18" | Canopy: 18" Round  
 Socket: 4 - E12 Candelabra | Bulb: 4 - 40 C



**C NW4021BSL**  
 Burnished Silver Leaf

**C NW4021GI**  
 Gilded Iron

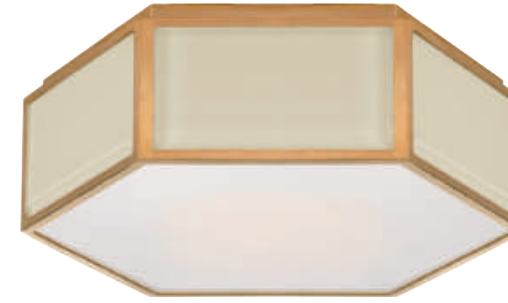

**D KS4120CRE/SB-FG**  
 Cream | Soft Brass | Frosted Glass

**D KS4120BLK/SB-FG**  
 Black | Soft Brass | Frosted Glass

**D BRADFORD SMALL HEXAGONAL FLUSH MOUNT**  
 kate spade new york

**KS4120**  
 H: 4.25" | W: 13"  
 Socket: 2 - E12 Candelabra | Bulb: 2 - 60 B

**Additional Options:**  
 Blush | Polished Nickel | Frosted Glass (BLS/PN-FG)  
 Mirror | Polished Nickel | Frosted Glass (MIR/PN-FG)  
 Mirror | Soft Brass | Frosted Glass (MIR/SB-FG)



**E KS4126PN-CG**  
 Polished Nickel | Crystal

**E KS4126SB-CG**  
 Soft Brass | Crystal

**E DARCY SMALL FLUSH MOUNT**  
 kate spade new york

**KS4126**  
 H: 6.25" | W: 11.75" | Canopy: 12" Round  
 Socket: 2 - E26 Keyless | Bulb: 2 - 40 G



**F KS4127PN-CG**  
 Polished Nickel | Crystal

**F KS4127SB-CG**  
 Soft Brass | Crystal

**F DARCY MEDIUM FLUSH MOUNT**  
 kate spade new york

**KS4127**  
 H: 7.25" | W: 15.75" | Canopy: 16" Round  
 Socket: 3 - E26 Keyless | Bulb: 3 - 40 G



**A** SK4010PN-FG  
Polished Nickel | Frosted Glass



**A** SK4010HAB-FG  
Hand-Rubbed Antique Brass | Frosted Glass



**A** SK4010BZ-FG  
Bronze | Frosted Glass



**D** SK4011HAB-FG  
Hand-Rubbed Antique Brass | Frosted Glass



**B** AH4200PN-FG  
Polished Nickel | Frosted Glass



**B** AH4200HAB-FG  
Hand-Rubbed Antique Brass | Frosted Glass



**B** AH4200BZ-FG  
Bronze | Frosted Glass



**C** AH4201PN-FG  
Polished Nickel | Frosted Glass



**C** AH4201HAB-FG  
Hand-Rubbed Antique Brass | Frosted Glass



**C** AH4201BZ-FG  
Bronze | Frosted Glass

**A** MONTPELIER SMALL FLUSH MOUNT  
SUZANNE KASLER

**SK4010**  
H: 6" | W: 11"  
Socket: 2 - E26 Keyless | Bulb: 2 - 60 B  
**Additional Options:**  
Antique Nickel | Frosted Glass (AN-FG)

**B** RANDOLPH SMALL FLUSH MOUNT  
ALEXA HAMPTON

**AH4200**  
H: 4.5" | W: 11.25"  
Socket: 2 - E26 Keyless | Bulb: 2 - 40 B

**C** RANDOLPH LARGE FLUSH MOUNT  
ALEXA HAMPTON

**AH4201**  
H: 4.5" | W: 14"  
Socket: 2 - E26 Keyless | Bulb: 2 - 60 B

**D** MONTPELIER LARGE FLUSH MOUNT  
SUZANNE KASLER

**SK4011**  
H: 6" | W: 16"  
Socket: 3 - E26 Keyless | Bulb: 3 - 60 B  
**Additional Options:**  
Antique Nickel | Frosted Glass (AN-FG)  
Bronze | Frosted Glass (BZ-FG)



**D** SK4011PN-FG  
Polished Nickel | Frosted Glass





**A WALKER SMALL FLUSH MOUNT**  
KATE SPADE NEW YORK

**KS4070**  
H: 6.25" | W: 13.75" | Canopy: 8.75" Round  
Socket: 2 - E26 Keyless | Bulb: 2 - 60 A

**B WALKER MEDIUM FLUSH MOUNT**  
KATE SPADE NEW YORK

**KS4071**  
H: 6.75" | W: 18" | Canopy: 8.75" Round  
Socket: 4 - E26 Keyless | Bulb: 4 - 40 A

**C WALKER LARGE FLUSH MOUNT**  
KATE SPADE NEW YORK

**KS4072**  
H: 6.75" | W: 24" | Canopy: 8.75" Round  
Socket: 4 - E26 Keyless | Bulb: 4 - 40 A  
**Additional Options:**  
Light Cream | Natural Linen (LC-NL)



**A KS4070BSL-L**  
Burnished Silver Leaf | Cream Linen



**A KS4070LC-NL**  
Light Cream | Natural Linen



**A KS4070G-L/BL**  
Gild | Cream Linen | Black Linen Trim



**B KS4071BSL-L**  
Burnished Silver Leaf | Cream Linen



**B KS4071LC-NL**  
Light Cream | Natural Linen



**B KS4071G-L/BL**  
Gild | Cream Linen | Black Linen Trim



**C KS4072BSL-L**  
Burnished Silver Leaf | Cream Linen



**C KS4072G-L/BL**  
Gild | Cream Linen | Black Linen Trim

**A KS4070G-L/BL**  
Gild | Cream Linen | Black Linen Trim



**A** | **ARN4021WHT/G-WG**  
White | Gild | White Glass



**A** | **ARN4021AI/G-WG**  
Aged Iron | Gild | White Glass



**B** | **ARN4022BSL-WG**  
Burnished Silver Leaf | White Glass



**B** | **ARN4022AI/G-WG**  
Aged Iron | Gild | White Glass



**C** | **ARN4023G-WG**  
Gild | White Glass



**C** | **ARN4023AI/G-WG**  
Aged Iron | Gild | White Glass

**A** | **MOLENE SMALL FLUSH MOUNT**  
AERIN  
  
**ARN4021**  
H: 8.5" | W: 11" | Canopy: 11" Round  
Socket: 2 - E12 Candelabra | Bulb: 2 - 40 B  
**Additional Options:**  
Burnished Silver Leaf | White Glass (BSL-WG)  
Gild | White Glass (G-WG)

**B** | **MOLENE MEDIUM FLUSH MOUNT**  
AERIN  
  
**ARN4022**  
H: 8.25" | W: 14.5" | Canopy: 14" Round  
Socket: 3 - E12 Candelabra | Bulb: 3 - 40 B  
**Additional Options:**  
Gild | White Glass (G-WG)  
White | Gild | White Glass (WHT/G-WG)

**C** | **MOLENE LARGE FLUSH MOUNT**  
AERIN  
  
**ARN4023**  
H: 8.25" | W: 18" | Canopy: 18" Round  
Socket: 4 - E12 Candelabra | Bulb: 4 - 40 B  
**Additional Options:**  
Burnished Silver Leaf | White Glass (BSL-WG)  
White | Gild | White Glass (WHT/G-WG)

opposite page

**D** | **HALO PETITE FLUSH MOUNT**  
BARBARA BARRY

**BBL4090**  
H: 2.5" | W: 5.5" | Canopy: 4.5" Round  
LED: 11w

**E** | **HAMPTON SMALL CHANDELIER**  
AERIN

**ARN4011**  
H: 8" | W: 16.75" | Canopy: 6" Round  
Socket: 3 - E12 Candelabra | Bulb: 3 - 60 C  
\* Ships with 3 Feet of Chain

**F** | **MILL SMALL FLUSH MOUNT**  
AERIN

**ARN4003**  
H: 8.25" | W: 15"  
Socket: 3 - E12 Candelabra | Bulb: 3 - 60 T  
**Additional Options:**  
Aged Iron (AI)



**D** | **BBL4090WHT**  
White



**D** | **BBL4090BSL**  
Burnished Silver Leaf



**D** | **BBL4090G**  
Gild



**D** | **BBL4090BLK**  
Matte Black



**E** | **ARN4011PW**  
Plaster White



**E** | **ARN4011BSL**  
Burnished Silver Leaf



**E** | **ARN4011G**  
Gild



**F** | **ARN4003PW**  
Plaster White



**F** | **ARN4003BSL**  
Burnished Silver Leaf



**F** | **ARN4003G**  
Gild



**A** **KS4015PN-CG**  
Polished Nickel | Clear Glass

**A** **KS4015SB-CG**  
Soft Brass | Clear Glass

**A** **KS4015AN-DCG**  
Antique Nickel | Dark Smoky Crystal



**B** **KS4065PN-CRE**  
Polished Nickel | Cream Tinted Glass

**B** **KS4065SB-CRE**  
Soft Brass | Cream Tinted Glass

**B** **KS4065SB-BLS**  
Soft Brass | Blush Tinted Glass



**C** **KS4311LC**  
Light Cream

**C** **KS4311G**  
Gild

**C** **KS4311BSL**  
Burnished Silver Leaf



**D** **KS4407SB-CG**  
Soft Brass | Clear Glass



**D** **KS4407PN-WG**  
Polished Nickel | White Glass

opposite page

**A** **LLOYD MEDIUM ROUND FLUSH MOUNT**  
kate spade new york

**KS4015**  
H: 4.5" | W: 13" | Canopy: 4.5" Round  
Socket: 3 - E12 Candelabra | Bulb: 3 - 60 B

**B** **LEIGHTON MEDIUM FLUSH MOUNT**  
kate spade new york

**KS4065**  
H: 7.5" | W: 20" | Canopy: 8" Round  
Socket: 3 - E12 Candelabra | Bulb: 3 - 40 B  
**Additional Options:**  
Polished Nickel | Blush Tinted Glass (PN-BLS)

**C** **KEATON BOUQUET FLUSH MOUNT**  
kate spade new york

**KS4311**  
H: 11.25" | W: 22.75" | Canopy: 8" Round  
Socket: 6 - E12 Candelabra | Bulb: 6 - 40 G

**D** **PRESCOTT MEDIUM SEMI-FLUSH MOUNT**  
kate spade new york

**KS4407**  
H: 14.25" | W: 18" | Canopy: 5" Round  
Socket: 4 - E12 Candelabra | Bulb: 4 - 40 G  
**Additional Options:**  
Polished Nickel | Clear Glass (PN-CG)  
Soft Brass | White Glass (SB-WG)



**A** **S7000PN-CG**  
Polished Nickel | Clear Cut Crystal



**A** **S7000HAB-CG**  
Hand-Rubbed Antique Brass | Clear Cut Crystal



**A** **S7000BZ-CG**  
Bronze | Clear Cut Crystal

**B** **KS4005SB-CG**  
Soft Brass | Clear Glass | Pearls



opposite page  
**A** **HILLAM SOLITAIRE FLUSH MOUNT**  
STUDIO VC  
**S7000**  
H: 3.5" | W: 5.5"  
LED: 12w



**B** **KS4005PN-CG**  
Polished Nickel | Clear Glass | Pearls



**B** **KS4005SB-CG**  
Soft Brass | Clear Glass | Pearls



**C** **SN4001PN**  
Polished Nickel | Crystal



**C** **SN4001HAB**  
Hand-Rubbed Antique Brass | Crystal

**B** **DICKINSON SEMI-FLUSH MOUNT**  
kate spade new york  
**KS4005**  
H: 16" | W: 22.25" | Canopy: 7" Round  
Socket: 9 - E12 Candelabra | Bulb: 9 - 60 G

**C** **TRILLION LARGE FLUSH MOUNT**  
JOE NYE  
**SN4001**  
H: 14.25" | W: 21" | Canopy: 5" Round  
Socket: 10 - E12 Candelabra | Bulb: 10 - 60 B  
**Additional Options:**  
Hand-Rubbed Antique Brass | Crystal (HAB)

**D** **CALAIS SEMI-FLUSH MOUNT**  
NIERMANN WEEKS  
**NW4051**  
H: 12" | W: 26" | Canopy: 5" Round  
Socket: 6 - E12 Candelabra | Bulb: 6 - 60 C



**D** **NW4051BSL-CG**  
Burnished Silver Leaf | Clear Glass

**D** **NW4051GI-CG**  
Gilded Iron | Clear Glass

**A QUINCY SMALL FLUSH MOUNT**  
E. F. CHAPMAN  
  
**CHC4509**  
H: 3.75" | W: 17.25" | Canopy: 6" Round  
LED: 9w  
©EFC DESIGNS



**A CHC4509PN-CA**  
Polished Nickel | Clear Acrylic

**A CHC4509AB-CA**  
Antique-Burnished Brass | Clear Acrylic

**B RENWICK LARGE FLUSH MOUNT**  
AERIN  
  
**ARN4004**  
H: 8.25" | W: 16.5"  
Socket: 3 - E12 Candelabra | Bulb: 3 - 40 C



**B ARN4004BSL-CG**  
Burnished Silver Leaf | Crystal

**B ARN4004G-CG**  
Gild | Crystal

**C LYNN LARGE FLUSH MOUNT**  
AERIN  
  
**ARN4120**  
H: 10.25" | W: 16.5"  
Socket: 8 - E12 Candelabra | Bulb: 8 - 60 C



**C ARN4120BSL**  
Burnished Silver Leaf | Clear Glass

**C ARN4120HAB**  
Hand-Rubbed Antique Brass | Clear Glass

**D NAVONA SMALL BASKET FLUSH MOUNT**  
JULIE NEILL  
  
**JN4120**  
H: 10.5" | W: 12.5" | Canopy: 12.25" Round  
Socket: 2 - E12 Candelabra | Bulb: 2 - 40 C



**D JN4120BSL/CG**  
Burnished Silver Leaf | Crystal

**D JN4120G/CG**  
Gild | Crystal

**E NAVONA MEDIUM BASKET FLUSH MOUNT**  
JULIE NEILL  
  
**JN4121**  
H: 11.75" | W: 17.5" | Canopy: 16" Round  
Socket: 3 - E12 Candelabra | Bulb: 3 - 40 C



**E JN4121BSL/CG**  
Burnished Silver Leaf | Crystal

**E JN4121G/CG**  
Gild | Crystal

**F NAVONA LARGE BASKET FLUSH MOUNT**  
JULIE NEILL  
  
**JN4122**  
H: 14.5" | W: 23.5" | Canopy: 22" Round  
Socket: 4 - E12 Candelabra | Bulb: 4 - 40 C



**F JN4122BSL/CG**  
Burnished Silver Leaf | Crystal

**F JN4122G/CG**  
Gild | Crystal



**A** | **ARN4105PN-CG**  
Polished Nickel | Crystal

**A** | **SANGER MEDIUM FLUSH MOUNT**  
AERIN  
  
**ARN4105**  
H: 8.25" | W: 16"  
Socket: 3 - E12 Candelabra | Bulb: 3 - 40 C

opposite page  
**B** | **PARIS FLEA MARKET SMALL FLUSH MOUNT**  
E. F. CHAPMAN  
  
**CHC4206**  
H: 7.5" | W: 10"  
Socket: 2 - E12 Candelabra | Bulb: 2 - 60 C  
©EFC DESIGNS

**C** | **PARIS FLEA MARKET MEDIUM FLUSH MOUNT**  
E. F. CHAPMAN  
  
**CHC4207**  
H: 9" | W: 13"  
Socket: 2 - E12 Candelabra | Bulb: 2 - 60 C  
©EFC DESIGNS

**D** | **JACQUELINE LARGE FLUSH MOUNT**  
AERIN  
  
**ARN4102**  
H: 12.25" | W: 18"  
Socket: 4 - E12 Candelabra | Bulb: 4 - 40 C

**D** | **ARN4102HAB-WG**  
Hand-Rubbed Antique Brass | White Acrylic



**B** | **CHC4206PS-SG**  
Polished Silver | Seeded Glass



**C** | **CHC4207PS-SG**  
Polished Silver | Seeded Glass



**D** | **ARN4102BSL-CG**  
Burnished Silver Leaf | White Acrylic



**B** | **CHC4206SHS-SG**  
Sheffield Silver | Seeded Glass



**C** | **CHC4207SHS-SG**  
Sheffield Silver | Seeded Glass



**D** | **ARN4102BSL-CG**  
Burnished Silver Leaf | Clear Glass



**B** | **CHC4206AB-SG**  
Antique-Burnished Brass | Seeded Glass



**C** | **CHC4207AB-SG**  
Antique-Burnished Brass | Seeded Glass



**D** | **ARN4102HAB-CG**  
Hand-Rubbed Antique Brass | Clear Glass



**A** **ARN4124PN-CG**  
Polished Nickel | Crystal

**A** **ARN4124HAB-CG**  
Hand-Rubbed Antique Brass | Crystal

**A** **BONNINGTON SMALL FLUSH MOUNT**  
AERIN  
  
**ARN4124**  
H: 8.25" | W: 14.25"  
Socket: 4 - E12 Candelabra | Bulb: 4 - 40 B



**D** **ARN4170BSL-CG**  
Burnished Silver Leaf | Crystal

**D** **ARN4170G-CG**  
Gild | Crystal

**D** **LISCIA SMALL FLUSH MOUNT**  
AERIN  
  
**ARN4170**  
H: 8.75" | W: 15" | Canopy: 9" Round  
Socket: 3 - E12 Candelabra | Bulb: 3 - 40 C



**B** **ARN4125PN**  
Polished Nickel

**B** **ARN4125HAB**  
Hand-Rubbed Antique Brass

**B** **BONNINGTON MEDIUM FLUSH MOUNT**  
AERIN  
  
**ARN4125**  
H: 8.5" | W: 18" | Canopy: 4.5" Round  
Socket: 4 - E12 Candelabra | Bulb: 4 - 40 C



**E** **ARN4171BSL-CG**  
Burnished Silver Leaf | Crystal

**E** **ARN4171G-CG**  
Gild | Crystal

**E** **LISCIA MEDIUM FLUSH MOUNT**  
AERIN  
  
**ARN4171**  
H: 8.75" | W: 19" | Canopy: 13" Round  
Socket: 4 - E12 Candelabra | Bulb: 4 - 40 C



**C** **ARN4126PN**  
Polished Nickel

**C** **ARN4126HAB**  
Hand-Rubbed Antique Brass

**C** **BONNINGTON LARGE FLUSH MOUNT**  
AERIN  
  
**ARN4126**  
H: 10.25" | W: 24.75" | Canopy: 4.5" Round  
Socket: 5 - E12 Candelabra | Bulb: 5 - 40 C



**F** **ARN4172BSL-CG**  
Burnished Silver Leaf | Crystal

**F** **ARN4172G-CG**  
Gild | Crystal

**F** **LISCIA LARGE FLUSH MOUNT**  
AERIN  
  
**ARN4172**  
H: 8.75" | W: 25" | Canopy: 18" Round  
Socket: 6 - E12 Candelabra | Bulb: 6 - 40 C



**C** | **CHC4392AB-WG**  
Antique Brass | White Glass

**A** | **CALLIOPE MARINE FLUSH MOUNT**  
THOMAS O'BRIEN  
  
**TOB4203**  
H: 4.5" | W: 11.5"  
Socket: 2 - E26 Keyless | Bulb: 2 - 60 B  
**Additional Options:**  
Chrome | White Glass (CH)



**A** | **TOB4203BZ**  
Bronze | White Glass

**A** | **TOB4203HAB**  
Hand-Rubbed Antique Brass | White Glass

**A** | **TOB4203PN**  
Polished Nickel | White Glass

**B** | **ALDERLY SMALL FLUSH MOUNT**  
E. F. CHAPMAN  
  
**CHC4391**  
H: 4.25" | W: 13"  
Socket: 2 - E12 Candelabra | Bulb: 2 - 60 C  
©EFC DESIGNS



**B** | **CHC4391BZ-WG**  
Bronze | White Glass

**B** | **CHC4391AB-WG**  
Antique Brass | White Glass

**B** | **CHC4391PN-WG**  
Polished Nickel | White Glass

**C** | **ALDERLY FLUSH MOUNT**  
E. F. CHAPMAN  
  
**CHC4392**  
H: 4.25" | W: 16"  
Socket: 2 - E12 Candelabra | Bulb: 2 - 60 C  
©EFC DESIGNS



**C** | **CHC4392BZ-WG**  
Bronze | White Glass

**C** | **CHC4392AB-WG**  
Antique Brass | White Glass

**C** | **CHC4392PN-WG**  
Polished Nickel | White Glass





**A** | **CHC4128PN-CG**  
Polished Nickel | Clear Glass



**A** | **CHC4128AB-CG**  
Antique-Burnished Brass | Clear Glass



**A** | **CHC4128BZ-CG**  
Bronze | Clear Glass



**D** | **CHC4129AB-CG**  
Antique-Burnished Brass | Clear Glass



**B** | **CHC4125PN-CG**  
Polished Nickel | Clear Glass



**B** | **CHC4125AB-CG**  
Antique-Burnished Brass | Clear Glass



**B** | **CHC4125BZ-CG**  
Bronze | Clear Glass



**C** | **CHC4126PN-CG**  
Polished Nickel | Clear Glass



**C** | **CHC4126AB-CG**  
Antique-Burnished Brass | Clear Glass



**C** | **CHC4126BZ-CG**  
Bronze | Clear Glass

**A** | **CLUB SMALL SQUARE FLUSH MOUNT**  
E. F. CHAPMAN

**CHC4128**  
H: 8.25" | W: 9"  
Socket: 3 - E12 Candelabra | Bulb: 3 - 60 C  
©EFC DESIGNS

**B** | **CLUB SMALL HEXAGONAL FLUSH MOUNT**  
E. F. CHAPMAN

**CHC4125**  
H: 8" | W: 11.5"  
Socket: 3 - E12 Candelabra | Bulb: 3 - 60 C  
©EFC DESIGNS

**C** | **CLUB LARGE HEXAGONAL FLUSH MOUNT**  
E. F. CHAPMAN

**CHC4126**  
H: 8.5" | W: 16"  
Socket: 3 - E12 Candelabra | Bulb: 3 - 60 C  
©EFC DESIGNS

**D** | **CLUB LARGE SQUARE FLUSH MOUNT**  
E. F. CHAPMAN

**CHC4129**  
H: 9" | W: 13"  
Socket: 3 - E12 Candelabra | Bulb: 3 - 60 C  
**Additional Options:**  
Polished Nickel | Clear Glass (PN-CG)  
©EFC DESIGNS



**D** | **CHC4129BZ-CG**  
Bronze | Clear Glass



**A TOB4220BSL**  
Burnished Silver Leaf | White Glass

**A ENRIQUE FLUSH MOUNT**  
THOMAS O'BRIEN  
  
**TOB4220**  
H: 4.5" | W: 16"  
Socket: 2 - E26 Keyless | Bulb: 2 - 60 B

opposite page

**B CROWN SQUARE FLUSH MOUNT**  
E. F. CHAPMAN  
  
**CHC4215**  
H: 6.25" | W: 14"  
Socket: 2 - E26 Keyless | Bulb: 2 - 60 B  
**Additional Options:**  
Antique Nickel | Frosted Glass (AN)  
©EFC DESIGNS

**C MORRIS FLUSH MOUNT**  
SUZANNE KASLER  
  
**SK4008**  
H: 5" | W: 15.5"  
Socket: 2 - E26 Keyless | Bulb: 2 - 60 A

**D MORRIS LARGE FLUSH MOUNT**  
SUZANNE KASLER  
  
**SK4009**  
H: 6" | W: 20"  
Socket: 4 - E26 Keyless | Bulb: 4 - 40 A



**A TOB4220GI**  
Gilded Iron | White Glass



**B CHC4215PN**  
Polished Nickel | Frosted Glass



**B CHC4215AB**  
Antique-Burnished Brass | Frosted Glass



**B CHC4215BZ**  
Bronze | Frosted Glass



**C SK4008PN-FG**  
Polished Nickel | Frosted Glass



**C SK4008GI-FG**  
Gilded Iron | Frosted Glass



**C SK4008AZ-FG**  
Antique Zinc | Frosted Glass



**D SK4009PN-FG**  
Polished Nickel | Frosted Glass



**D SK4009GI-FG**  
Gilded Iron | Frosted Glass



**D SK4009AZ-FG**  
Antique Zinc | Frosted Glass



**A** SS4010BZ-FG  
Bronze | Frosted Glass



**A** SS4010HAB-FG  
Hand-Rubbed Antique Brass | Frosted Glass



**A** SS4010PN-FG  
Polished Nickel | Frosted Glass



**D** SS4011PN-FG  
Polished Nickel | Frosted Glass

**D** SS4011HAB-FG  
Hand-Rubbed Antique Brass | Frosted Glass



**B** AH4029GM-WG  
Gun Metal | White Glass



**B** AH4029NB-WG  
Natural Brass | White Glass



**B** AH4029PN-WG  
Polished Nickel | White Glass



**C** AH4030GM-WG  
Gun Metal | White Glass



**C** AH4030NB-WG  
Natural Brass | White Glass



**C** AH4030PN-WG  
Polished Nickel | White Glass

**A OPENWORK SMALL FLUSH MOUNT**  
STUDIO VC  
**SS4010**  
H: 4" | W: 10"  
Socket: 2 - E12 Candelabra | Bulb: 2 - 40 C  
**Additional Options:**  
Antique Nickel | Frosted Glass (AN-FG)  
Chrome | Frosted Glass (CH-FG)

**B RACHEL SMALL FLUSH MOUNT**  
ALEXA HAMPTON  
**AH4029**  
H: 4" | W: 13.5"  
Socket: 2 - E26 Keyless | Bulb: 2 - 60 B

**C RACHEL LARGE FLUSH MOUNT**  
ALEXA HAMPTON  
**AH4030**  
H: 5" | W: 18"  
Socket: 2 - E26 Keyless | Bulb: 2 - 60 B

**D OPENWORK LARGE FLUSH MOUNT**  
STUDIO VC  
**SS4011**  
H: 5" | W: 13.5"  
Socket: 2 - E12 Candelabra | Bulb: 2 - 40 C  
**Additional Options:**  
Antique Nickel | Frosted Glass (AN-FG)  
Bronze | Frosted Glass (BZ-FG)  
Chrome | Frosted Glass (CH-FG)





**A** | **TOB4216PN-WG**  
Polished Nickel | White Glass

**B** | **TOB4215PN-WG**  
Polished Nickel | White Glass



**A** | **TOB4216HAB-WG**  
Hand-Rubbed Antique Brass | White Glass

**B** | **TOB4215HAB-WG**  
Hand-Rubbed Antique Brass | White Glass



**A** | **TOB4216BZ-WG**  
Bronze | White Glass

**B** | **TOB4215BZ-WG**  
Bronze | White Glass

**A** | **NEWHOUSE CIRCULAR FLUSH MOUNT**  
THOMAS O'BRIEN

**TOB4216**  
H: 4.5" | W: 12.25"  
Socket: 2 - E26 Keyless | Bulb: 2 - 60 B  
**Additional Options:**  
Antique Nickel | White Glass (AN-WG)

**B** | **NEWHOUSE BLOCK WALL/CEILING LIGHT**  
THOMAS O'BRIEN

**TOB4215**  
H: 3.5" | W: 6.25 x 10.25"  
Socket: E26 Keyless | Bulb: 60 B  
**Additional Options:**  
Antique Nickel | White Glass (AN-WG)

opposite page

**C** | **LAUNCETON PETITE FLUSH MOUNT**  
E. F. CHAPMAN

**CHC4600**  
H: 3.25" | W: 5" | Canopy: 5" Round  
LED: 11w  
©EFC DESIGNS

**D** | **HICKS PETITE FLUSH MOUNT**  
THOMAS O'BRIEN

**TOB4062**  
H: 2.5" | W: 5.5"  
LED: 11w

**E** | **HICKS SMALL FLUSH MOUNT**  
THOMAS O'BRIEN

**TOB4063**  
H: 6.5" | W: 13"  
Socket: 2 - E26 Keyless | Bulb: 2 - 60 A  
**Additional Options:**  
Antique Nickel | White Glass (AN-WG)



**C** | **CHC4600PN-WG**  
Polished Nickel | White Glass

**C** | **CHC4600AN-WG**  
Antique Nickel | White Glass

**C** | **CHC4600AB-WG**  
Antique-Burnished Brass | White Glass

**C** | **CHC4600BZ-WG**  
Bronze | White Glass



**D** | **TOB4062PN-WG**  
Polished Nickel | White Glass

**D** | **TOB4062AN-WG**  
Antique Nickel | White Glass

**D** | **TOB4062HAB-WG**  
Hand-Rubbed Antique Brass | White Glass

**D** | **TOB4062BZ/HAB-WG**  
Bronze | Hand-Rubbed Antique Brass | White Glass



**E** | **TOB4063PN-WG**  
Polished Nickel | White Glass

**E** | **TOB4063HAB-WG**  
Hand-Rubbed Antique Brass | White Glass

**E** | **TOB4063BZ/HAB-WG**  
Bronze | Hand-Rubbed Antique Brass | White Glass



**A** | **SL4001PN-WG**  
Polished Nickel | White Glass



**A** | **SL4001HAB-WG**  
Hand-Rubbed Antique Brass | White Glass



**A** | **SL4001BZ-WG**  
Bronze | White Glass



**B** | **SL4002PN-WG**  
Polished Nickel | White Glass



**B** | **SL4002HAB-WG**  
Hand-Rubbed Antique Brass | White Glass



**B** | **SL4002BZ-WG**  
Bronze | White Glass



**C** | **SS4016PN-WG**  
Polished Nickel | White Glass



**C** | **SS4016HAB-WG**  
Hand-Rubbed Antique Brass | White Glass



**C** | **SS4016BZ-WG**  
Bronze | White Glass

**A** | **MARINE MEDIUM FLUSH MOUNT**  
E. F. CHAPMAN

**SL4001**  
H: 4.75" | W: 8.25"  
Socket: E26 Keyless | Bulb: 60 B  
**Additional Options:**  
Antique Nickel | White Glass (AN-WG)  
Chrome | White Glass (CH-WG)  
©EFC DESIGNS

**B** | **MARINE LARGE FLUSH MOUNT**  
E. F. CHAPMAN

**SL4002**  
H: 7" | W: 12.75"  
Socket: 2 - E26 Keyless | Bulb: 2 - 60 B  
**Additional Options:**  
Antique Nickel | White Glass (AN-WG)  
Chrome | White Glass (CH-WG)  
©EFC DESIGNS

**C** | **SIENA LARGE FLUSH MOUNT**  
STUDIO VC

**SS4016**  
H: 4.75" | W: 14"  
Socket: 2 - E26 Keyless | Bulb: 2 - 60 B  
**Additional Options:**  
Antique Nickel | White Glass (AN-WG)  
Chrome | White Glass (CH-WG)

**D** | **SIENA SMALL FLUSH MOUNT**  
STUDIO VC

**SS4015**  
H: 4.25" | W: 11.75"  
Socket: 2 - E26 Keyless | Bulb: 2 - 40 B  
**Additional Options:**  
Antique Nickel | White Glass (AN-WG)  
Chrome | White Glass (CH-WG)  
Polished Nickel | White Glass (PN-WG)



**D** | **SS4015HAB-WG**  
Hand-Rubbed Antique Brass | White Glass



**D** | **SS4015BZ-WG**  
Bronze | White Glass



A PB4001NB  
Natural Brass



A PB4001MBK  
Matte Black

A DOT 13" CAGED FLUSH MOUNT  
PETER BRISTOL

**PB4001**  
H: 3.5" | W: 13.75" | Canopy: 6"  
LED: 18w  
**Additional Options:**  
Polished Nickel (PN)

opposite page

B DOT 16" CAGED FLUSH MOUNT  
PETER BRISTOL

**PB4004**  
H: 4.5" | W: 16.5" | Canopy: 6"  
LED: 24w

C DOT 13" FLUSH MOUNT  
PETER BRISTOL

**PB4000**  
H: 2.25" | W: 13.75" | Canopy: 6"  
LED: 18w

D DOT 16" FLUSH MOUNT  
PETER BRISTOL

**PB4003**  
H: 2.75" | W: 16.5" | Canopy: 6"  
LED: 24w



B PB4004PN  
Polished Nickel



B PB4004NB  
Natural Brass



B PB4004MBK  
Matte Black



C PB4000PN  
Polished Nickel



C PB4000NB  
Natural Brass



C PB4000MBK  
Matte Black



D PB4003PN  
Polished Nickel



D PB4003NB  
Natural Brass



D PB4003MBK  
Matte Black



**A** | **TOB4011AN-WG**  
Antique Nickel | White Glass



**B** | **TOB4013AN-WG**  
Antique Nickel | White Glass



**A** | **TOB4011HAB-WG**  
Hand-Rubbed Antique Brass | White Glass



**B** | **TOB4013HAB-WG**  
Hand-Rubbed Antique Brass | White Glass



**A** | **TOB4011BZ-WG**  
Bronze | White Glass



**B** | **TOB4013BZ-WG**  
Bronze | White Glass

**A** | **MILTON SHORT FLUSH MOUNT**  
THOMAS O'BRIEN

**TOB4011**  
H: 6" | W: 9.5"  
Socket: E26 Keyless | Bulb: 60 B

**B** | **MILTON LARGE FLUSH MOUNT**  
THOMAS O'BRIEN

**TOB4013**  
H: 6" | W: 14.5"  
Socket: 2 - E26 Keyless | Bulb: 2 - 60 B



**A** | **TOB4011PN-WG**  
Polished Nickel | White Glass



**B** | **TOB4013PN-WG**  
Polished Nickel | White Glass



**A ACME SMALL FLUSH MOUNT**  
BARBARA BARRY  
**BBL4105**  
H: 5.75" | W: 9"  
Socket: 3 - E12 Candelabra | Bulb: 3 - 40 B

**B ACME LARGE FLUSH MOUNT**  
BARBARA BARRY  
**BBL4106**  
H: 7" | W: 16.25"  
Socket: 3 - E26 Keyless | Bulb: 3 - 40 A

**A BBL4105PN-WG**  
Polished Nickel | White Glass

**B BBL4106PN-WG**  
Polished Nickel | White Glass



**A BBL4105SB-WG**  
Soft Brass | White Glass

**B BBL4106SB-WG**  
Soft Brass | White Glass



**A BBL4105BZ-WG**  
Bronze | White Glass

**B BBL4106BZ-WG**  
Bronze | White Glass

opposite page

**C TABLEAU PETITE FLUSH MOUNT**  
KELLY WEARSTLER  
**KW4270**  
H: 4.25" | W: 6" | Canopy: 4.5" Round  
LED: 11w  
\* Requires Smaller Outlet Box

**D TABLEAU MEDIUM FLUSH MOUNT**  
KELLY WEARSTLER

**KW4271**  
H: 8.75" | W: 15" | Canopy: 7" Round  
Socket: E26 Keyless | Bulb: 60 T



**C KW4270PN-VG**  
Polished Nickel | Volcanic Glass

**C KW4270AB-VG**  
Antique-Burnished Brass | Volcanic Glass

**C KW4270BZ-VG**  
Bronze | Volcanic Glass



**D KW4271PN-CG**  
Polished Nickel | Clear Glass

**D KW4271AB-CG**  
Antique-Burnished Brass | Clear Glass

**D KW4271BZ-CG**  
Bronze | Clear Glass



**D KW4271PN-VG**  
Polished Nickel | Volcanic Glass

**D KW4271AB-VG**  
Antique-Burnished Brass | Volcanic Glass

**D KW4271BZ-VG**  
Bronze | Volcanic Glass





**A** | **CHC4132PN-CG** Polished Nickel | Clear Glass

**A** | **CHC4132AN-CG** Antique Nickel | Clear Glass

**A** | **CHC4132AB-CG** Antique-Burnished Brass | Clear Glass

**A** | **CHC4132BZ-CG** Bronze | Clear Glass



**A** | **CHC4132PN-WG** Polished Nickel | White Glass

**A** | **CHC4132AN-WG** Antique Nickel | White Glass

**A** | **CHC4132AB-WG** Antique-Burnished Brass | White Glass

**A** | **CHC4132BZ-WG** Bronze | White Glass

opposite page

**A** | **EDWARDIAN OPEN BOTTOM FLUSH MOUNT**  
E. F. CHAPMAN

**CHC4132**  
H: 11.5" | W: 10" | Canopy: 8" Round  
Socket: E26 Keyless | Bulb: 60 B  
©EFC DESIGNS



**B** | **SL5001PN** Polished Nickel

**B** | **SL5001AN** Antique Nickel

**B** | **SL5001HAB** Hand-Rubbed Antique Brass

**B** | **SL5001BZ** Bronze



**B** | **SL5001PN/SLEG-WG** Polished Nickel | White Glass

**B** | **SL5001AN/SLEG-WG** Antique Nickel | White Glass

**B** | **SL5001HAB/SLEG-WG** Hand-Rubbed Antique Brass | White Glass

**B** | **SL5001BZ/SLEG-WG** Bronze | White Glass

**B** | **BOSTON FLUSH MOUNT**  
E. F. CHAPMAN

**SL5001**  
H: 8.5" | W: 5.5" | Canopy: 5" Round  
Socket: E26 Keyless | Bulb: 60 B  
©EFC DESIGNS



**A** | **SL4121HAB-WG**  
Hand-Rubbed Antique Brass | White Glass

**A** | **SL4121BZ-WG**  
Bronze | White Glass

**A** | **SL4121AN-WG**  
Antique Nickel | White Glass

**A** | **SL4121PN-WG**  
Polished Nickel | White Glass



**B** | **TOB5150HAB-WG**  
Hand-Rubbed Antique Brass | White Glass

**B** | **TOB5150BZ-WG**  
Bronze | White Glass

**B** | **TOB5150AN-WG**  
Antique Nickel | White Glass

**B** | **TOB5150PN-WG**  
Polished Nickel | White Glass

**A** | **EDMOND FLUSH MOUNT**  
E. F. CHAPMAN  
  
**SL4121**  
H: 19" | W: 14.5" | Canopy: 5.75" Round  
Socket: E26 Keyless | Bulb: 150 A  
©EFC DESIGNS

**B** | **MILTON ROAD FLUSH MOUNT**  
THOMAS O'BRIEN  
  
**TOB5150**  
H: 18" | W: 14.75" | Canopy: 5.75" Round  
Socket: E26 Keyless | Bulb: 75 A  
\* Includes Installation Hardware for  
Flush Mount and Pendant



**A** | **SL4121HAB-WG**  
Hand-Rubbed Antique Brass | White Glass



**A** | **TOB4006PN-WG**  
Polished Nickel | White Glass



**A** | **TOB4006BZ-WG**  
Bronze | White Glass

**A** | **TOB4006HAB-WG**  
Hand-Rubbed Antique Brass | White Glass



opposite page

**A** | **CLARK FLUSH MOUNT**  
THOMAS O'BRIEN

**TOB4006**  
H: 12.75" | W: 7.5" | Canopy: 7.5" Round  
Socket: E26 Keyless | Bulb: 75 A  
**Additional Options:**  
Antique Nickel | White Glass (AN-WG)



**B** | **TOB4155PN-WG**  
Polished Nickel | White Glass



**B** | **TOB4155HAB-WG**  
Hand-Rubbed Antique Brass | White Glass



**B** | **TOB4155BZ-WG**  
Bronze | White Glass



**B** | **GALE PETITE FLUSH MOUNT**  
THOMAS O'BRIEN

**TOB4155**  
H: 3.5" | W: 5.5" | Canopy: 5" Round  
LED: 11w

**C** | **PERRY FLUSH MOUNT**  
THOMAS O'BRIEN

**TOB4000**  
H: 9" | W: 9.5" | Canopy: 7.25" Round  
Socket: E26 Keyless | Bulb: 60 B  
**Additional Options:**  
Antique Nickel | White Glass (AN)

**C** | **TOB4000PN**  
Polished Nickel | White Glass

**C** | **TOB4000HAB**  
Hand-Rubbed Antique Brass | White Glass

**C** | **TOB4000BZ**  
Bronze | White Glass



**A** | **ARN4007PN-WG**  
Polished Nickel | White Strie Glass



**A** | **ARN4007HAB-WG**  
Hand-Rubbed Antique Brass | White Strie Glass

**A** | **SEREIN PETITE FLUSH MOUNT**  
AERIN  
  
**ARN4007**  
H: 3.5" | W: 5.5" | Canopy: 5.5" Round  
LED: 11w



**B** | **ARN4009PN-WG**  
Polished Nickel | White Strie Glass



**B** | **ARN4009HAB-WG**  
Hand-Rubbed Antique Brass | White Strie Glass

**B** | **SEREIN MEDIUM FLUSH MOUNT**  
AERIN  
  
**ARN4009**  
H: 8.5" | W: 14"  
Socket: 3 - E12 Candelabra | Bulb: 3 - 60 B



**C** | **ARN4010PN-WG**  
Polished Nickel | White Strie Glass



**C** | **ARN4010HAB-WG**  
Hand-Rubbed Antique Brass | White Strie Glass

**C** | **SEREIN LARGE FLUSH MOUNT**  
AERIN  
  
**ARN4010**  
H: 10" | W: 17.5"  
Socket: 4 - E12 Candelabra | Bulb: 4 - 60 B



**D** | **ARN4321PN-WG**  
Polished Nickel | Strie Glass

**D** | **MEZAN LARGE FLUSH MOUNT**  
AERIN  
  
**ARN4321**  
H: 5.5" | W: 15.5"  
Socket: 4 - E12 Candelabra | Bulb: 4 - 40 B



**D** | **ARN4321HAB-WG**  
Hand-Rubbed Antique Brass | Strie Glass



**B** | **ARN4000HAB-WG**  
Hand-Rubbed Antique Brass | Strie Glass

**A** | **CRISTOL LARGE TRIPLE FLUSH MOUNT**  
AERIN  
**ARN4401**  
H: 9.75" | W: 15.25"  
Socket: 3 - E12 Candelabra | Bulb: 3 - 40 B



**A** | **ARN4401PN-WG**  
Polished Nickel | White Strie Glass

**A** | **ARN4401HAB-WG**  
Hand-Rubbed Antique Brass | White Strie Glass

**B** | **ROSEHILL SEMI-FLUSH MOUNT**  
AERIN  
**ARN4000**  
H: 10.25" | W: 16" | Canopy: 5.75" Round  
Socket: 3 - E12 Candelabra | Bulb: 3 - 60 B



**B** | **ARN4000PN-WG**  
Polished Nickel | Strie Glass

**B** | **ARN4000HAB-WG**  
Hand-Rubbed Antique Brass | Strie Glass

**C** | **ROSEHILL LARGE FLUSH MOUNT**  
AERIN  
**ARN4001**  
H: 10.25" | W: 21" | Canopy: 5.75" Round  
Socket: 4 - E12 Candelabra | Bulb: 4 - 40 C



**C** | **ARN4001PN-WG**  
Polished Nickel | Strie Glass

**C** | **ARN4001HAB-WG**  
Hand-Rubbed Antique Brass | Strie Glass



**A** **CHC2109PN**  
Polished Nickel | Clear Glass

**A** **CHC2109AB**  
Antique-Burnished Brass | Clear Glass

**A** **CHC2109BZ**  
Bronze | Clear Glass

**A** **COUNTRY SEMI-FLUSH BELL JAR LANTERN**  
E. F. CHAPMAN  
  
**CHC2109**  
H: 16.5" | W: 13" | Canopy: 6" Round  
Socket: 3 - E12 Candelabra | Bulb: 3 - 60 C  
©EFC DESIGNS  
**Additional Options:**  
Antique Nickel | Clear Glass (AN)

**B** **MERCHANT SEMI-FLUSH LANTERN**  
THOMAS O'BRIEN  
  
**TOB4212**  
H: 16.5" | W: 11.25" | Canopy: 5.25" Round  
Socket: 3 - E12 Candelabra | Bulb: 3 - 60 C  
**Additional Options:**  
Antique Nickel | Clear Glass (AN)

**C** **SUSSEX SEMI-FLUSH LANTERN**  
E. F. CHAPMAN  
  
**CHC2209**  
H: 18" | W: 12" | Canopy: 6" Round  
Socket: 4 - E12 Candelabra | Bulb: 4 - 60 C  
**Additional Options:**  
Antique Nickel | Clear Glass (AN)  
©EFC DESIGNS



**B** **TOB4212PN**  
Polished Nickel | Clear Glass

**B** **TOB4212HAB**  
Hand-Rubbed Antique Brass | Clear Glass

**B** **TOB4212BZ**  
Bronze | Clear Glass



**C** **CHC2209PN**  
Polished Nickel | Clear Glass

**C** **CHC2209AB**  
Antique-Burnished Brass | Clear Glass

**C** **CHC2209BZ**  
Bronze | Clear Glass



**A** **CHC2109AB**  
Antique-Burnished Brass | Clear Glass

**D** **LORFORD MEDIUM SEMI-FLUSH LANTERN**  
E. F. CHAPMAN  
  
**CHC4270**  
H: 15" | Fixture: 13.5" H | W: 19.75"  
Canopy: 5.5" Round  
Socket: 3 - E26 Keyless | Bulb: 3 - 40 B  
©EFC DESIGNS



**D** **CHC4270GI-MG**  
Gilded Iron | Mercury Glass



**D** **CHC4270AI-MG**  
Aged Iron | Mercury Glass



WALL



WALL | DECORATIVE



**A** **KS2062PN-CG**  
Polished Nickel | Etched Clear Glass



**A** **KS2062SB-CG**  
Soft Brass | Etched Clear Glass



**B** **KS2060SB-CG**  
Soft Brass | Etched Clear Glass



**C** **LR2905PN-CG**  
Polished Nickel | Crystal



**D** **LR2907HAB-CG**  
Hand-Rubbed Antique Brass | Crystal



**E** **LR2909PN-CG**  
Polished Nickel | Crystal



**E** **LR2909BZ-CG**  
Bronze | Crystal



opposite page

**A** **CASTLE PEAK LARGE SCONCE**  
kate spade new york

**KS2062**  
H: 12.5" | W: 8" | Ext: 5.25"  
Backplate: 7.5" x 12" Rec.  
Socket: E26 Keyless | Bulb: 60 A

**B** **CASTLE PEAK SMALL SCONCE**  
kate spade new york

**KS2060**  
H: 12.5" | W: 5" | Ext: 5"  
Backplate: 5" x 12" Rec.  
Socket: E26 Keyless | Bulb: 60 T

**C** **FASCIO 14" SCONCE**  
LAUREN ROTTET

**LR2905**  
H: 14" | W: 4.5" | Ext: 3.5"  
Backplate: 4.5" Square  
LED: 17w

**D** **FASCIO 14" ASYMMETRIC SCONCE**  
LAUREN ROTTET

**LR2907**  
H: 14" | W: 4.5" | Ext: 4"  
Backplate: 4.5" Square  
LED: 17w

**E** **FASCIO 18" SCONCE**  
LAUREN ROTTET

**LR2909**  
H: 18" | W: 4.25" | Ext: 4"  
Backplate: 4.25" x 6" Rec.  
LED: 17w

**F** **FASCIO 36" SCONCE**  
LAUREN ROTTET

**LR2910**  
H: 24" | W: 4.25" | Ext: 4"  
Backplate: 4.25" x 5" Rec.  
LED: 34w

**Available Options for Fascio:**  
Bronze | Crystal (BZ-CG)  
Hand-Rubbed Antique Brass | Crystal (HAB-CG)  
Polished Nickel | Crystal (PN-CG)

**F** **LR2910PN-CG**  
Polished Nickel | Crystal



**F** **LR2910HAB-CG**  
Hand-Rubbed Antique Brass | Crystal

A | ARN2124PN-CG  
Polished Nickel | Crystal



**A BONNINGTON WALL SCONCE**  
AERIN

**ARN2124**  
H: 12" | W: 6.75" | Ext: 4.75"  
Backplate: 4.5" x 7.25" Rec.  
Socket: E12 Candelabra | Bulb: 60 B

**B BONNINGTON TALL SCONCE**  
AERIN

**ARN2125**  
H: 22" | W: 7.5" | Ext: 4.75"  
Backplate: 4.5" x 12" Rec.  
Socket: 2 - E26 Keyless | Bulb: 2 - 40 T

**C ADELE WIDE SCONCE**  
SUZANNE KASLER

**SK2400**  
H: 14" | W: 10.75" | Ext: 6.75"  
Socket: 2 - E12 Candelabra  
Socket: 2 - E26 Keyless | Bulb: 2 - 40 B

**D ADELE TALL SCONCE**  
SUZANNE KASLER

**SK2404**  
H: 24" | W: 7" | Ext: 5"  
Backplate: 3.75" x 11.5" Rec.  
Socket: 2 - E12 Candelabra | Bulb: 2 - 40 C

A | ARN2124PN-CG  
Polished Nickel | Crystal



A | ARN2124HAB-CG  
Hand-Rubbed Antique Brass | Crystal

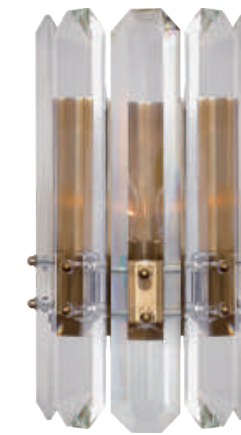

C | SK2400PN-CA  
Polished Nickel | Clear Acrylic



C | SK2400HAB-CA  
Hand-Rubbed Antique Brass | Clear Acrylic



B | ARN2125PN  
Polished Nickel



B | ARN2125HAB  
Hand-Rubbed Antique Brass

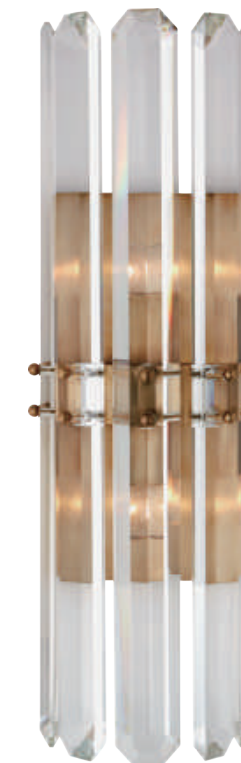

D | SK2404PN-CA  
Polished Nickel | Clear Acrylic



D | SK2404HAB-CA  
Hand-Rubbed Antique Brass | Clear Acrylic



**A** | **ARN2105PN-CG**  
Polished Nickel | Crystal



**A** | **SANGER LARGE SCONCE**  
AERIN  
**ARN2105**  
H: 13" | W: 10.25" | Ext: 6.25"  
Backplate: 6.25" x 10" Rec.  
Socket: 2 - E12 Candelabra | Bulb: 2 - 60 C

**B** | **SANGER LONG SCONCE**  
AERIN  
**ARN2305**  
H: 17.25" | W: 8" | Ext: 5.25"  
Backplate: 7.5" x 17.25" Rec.  
Socket: 2 - E12 Candelabra | Bulb: 2 - 40 C

**C** | **ARN2170BSL-CG**  
Burnished Silver Leaf | Crystal



**C** | **ARN2170G-CG**  
Gild | Crystal



**E** | **ARN2026PN**  
Polished Nickel | Clear Glass



**E** | **ARN2026HAB**  
Hand-Rubbed Antique Brass | Clear Glass



**E** | **EATON SCONCE**  
AERIN  
**ARN2026**  
H: 14" | W: 7.5" | Ext: 4.75"  
Backplate: 4.25" x 13" Rec.  
Socket: 2 - E12 Candelabra | Bulb: 2 - 40 C

**F** | **EATON LINEAR SCONCE**  
AERIN  
**ARN2027**  
H: 21" | W: 5.5" | Ext: 4.5"  
Backplate: 5.25" x 20" Rec.  
Socket: 3 - E12 Candelabra | Bulb: 3 - 40 C

**G** | **ARN2040BSL-CG**  
Burnished Silver Leaf | Clear Glass



**B** | **ARN2305PN-CG**  
Polished Nickel | Crystal



**C** | **LISCIA 12" SCONCE**  
AERIN  
**ARN2170**  
H: 12.5" | W: 6" | Ext: 4.25"  
Backplate: 4.25" x 10" Rec.  
Socket: E12 Candelabra | Bulb: 40 C

**D** | **LISCIA 22" SCONCE**  
AERIN  
**ARN2171**  
H: 21.75" | W: 6" | Ext: 4.25"  
Backplate: 4.25" x 19.5" Rec.  
Socket: 3 - E12 Candelabra | Bulb: 3 - 40 C

**D** | **ARN2171BSL-CG**  
Burnished Silver Leaf | Crystal



**D** | **ARN2171G-CG**  
Gild | Crystal



**F** | **ARN2027PN**  
Polished Nickel



**F** | **ARN2027HAB**  
Hand-Rubbed Antique Brass

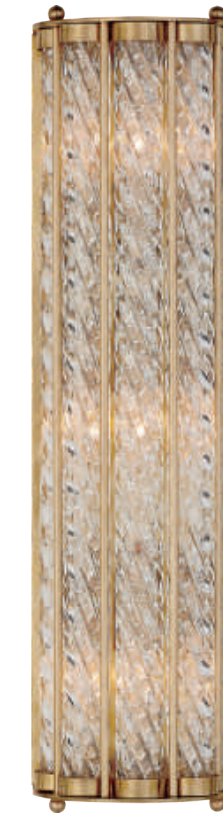

**G** | **ARN2040G-CG**  
Gild | Clear Glass



**G** | **RENE WALL SCONCE**  
AERIN  
**ARN2040**  
H: 15" | W: 9" | Ext: 4.75"  
Backplate: 5.25" x 14.5" Rec.  
Socket: E12 Candelabra | Bulb: 60 B

**A** | **ARN2103BSL-CG**  
Burnished Silver Leaf | Clear Glass



**A** | **ARN2103HAB-CG**  
Hand-Rubbed Antique Brass | Clear Glass



**A** | **JACQUELINE MEDIUM SCONCE**  
AERIN  
**ARN2103**  
H: 10.25" | W: 10" | Ext: 5.75"  
Backplate: 6.5" x 8" Rec.  
Socket: E12 Candelabra | Bulb: 40 B

**B** | **ARN2007BSL-CG**  
Burnished Silver Leaf | Clear Glass



**C** | **KS2065PN-CRE**  
Polished Nickel | Cream Tinted Glass



**C** | **LEIGHTON SMALL SCONCE**  
kate spade new york  
**KS2065**  
H: 11.5" | W: 7.75" | Ext: 4"  
Backplate: 4.5" x 9" Rec.  
Socket: 2 - E12 Candelabra | Bulb: 2 - 60 B  
**Additional Options:**  
Polished Nickel | Blush Tinted Glass (PN-BLS)  
Soft Brass | Blush Tinted Glass (SB-BLS)

**D** | **KS2015PN-CG**  
Polished Nickel | Clear Crystal



**D** | **KS2015SB-CG**  
Soft Brass | Clear Crystal



**A** | **ARN2103BSL-WG**  
Burnished Silver Leaf | White Acrylic



**A** | **ARN2103HAB-WG**  
Hand-Rubbed Antique Brass | White Acrylic



**B** | **LYNN MEDIUM SCONCE**  
AERIN  
**ARN2007**  
H: 14.25" | W: 12.25" | Ext: 7.5"  
Backplate: 4.5" Round  
Socket: 3 - E12 Candelabra | Bulb: 3 - 60 C

**B** | **ARN2007HAB-CG**  
Hand-Rubbed Antique Brass | Clear Glass

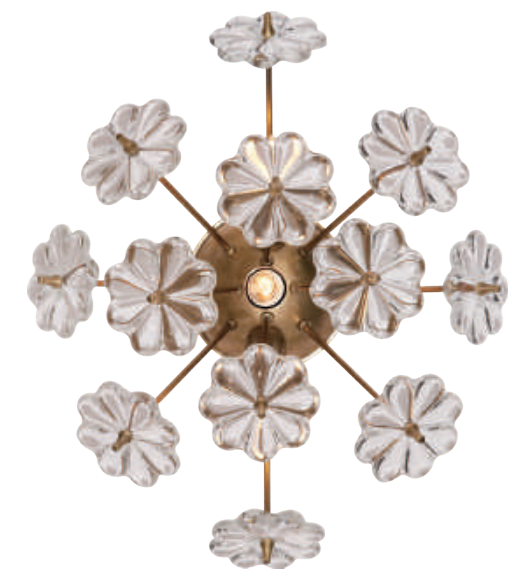

**C** | **KS2065SB-CRE**  
Soft Brass | Cream Tinted Glass



**D** | **LLOYD SMALL JEWELLED SCONCE**  
kate spade new york  
**KS2015**  
H: 10" | W: 6" | Ext: 3.5"  
Backplate: 4" Square  
Socket: E12 Candelabra | Bulb: 40 B  
**Additional Options:**  
Antique Nickel | Dark Smoky Crystal (AN-DCG)

**E** | **LLOYD LARGE JEWELLED SCONCE**  
kate spade new york  
**KS2017**  
H: 18.5" | W: 6.25" | Ext: 4"  
Backplate: 4" x 12.25" Rec.  
Socket: 2 - E12 Candelabra | Bulb: 2 - 40 B  
**Additional Options:**  
Polished Nickel | Clear Crystal (PN-CG)

**E** | **KS2017AN-DCG**  
Antique Nickel | Dark Smoky Crystal



**E** | **KS2017SB-CG**  
Soft Brass | Clear Crystal





**A** | **ARN2226BSL-L**  
Burnished Silver Leaf | Crystal | Linen

**A** | **ARN2226BSL-L**  
Burnished Silver Leaf | Crystal | Linen



**A** | **CLARET TAIL SCONCE**  
AERIN  
**ARN2226**  
H: 23.5" | W: 10" | Ext: 5.75"  
Backplate: 4.5" x 6.5" Oval  
Socket: E12 Candelabra | Bulb: 40 C  
Shade: 9" x 10" x 8" Rec. Shield

**B** | **JN2201BSL/CG-L**  
Burnished Silver Leaf | Crystal | Linen



**B** | **JN2201G/CG-L**  
Gild | Crystal | Linen



**A** | **ARN2226G-L**  
Gild | Linen



**B** | **MILAZZO MEDIUM LEFT SCONCE**  
JULIE NEILL  
**JN2201**  
H: 24" | W: 11.5" | Ext: 4.25"  
Backplate: 4.5" x 5.75" Rec.  
Socket: E12 Candelabra | Bulb: 40 B  
Shade: 11.5" x 11.5" x 8.5"

**C** | **JN2202BSL/CG-L**  
Burnished Silver Leaf | Crystal | Linen



**C** | **JN2202G/CG-L**  
Gild | Crystal | Linen



**C** | **MILAZZO MEDIUM RIGHT SCONCE**  
JULIE NEILL  
**JN2202**  
H: 24" | W: 11.5" | Ext: 4.25"  
Backplate: 4.5" x 5.75" Rec.  
Socket: E12 Candelabra | Bulb: 40 B  
Shade: 11.5" x 11.5" x 8.5"

**A** **CHD1549BW-SG**  
Belgian White | Seeded Glass Trim



**B** **JN2016VWG-CG**  
Vintage White | Gild | Crystal



**A** **FLANDERS LARGE SCONCE**  
E. F. CHAPMAN

**CHD1549**  
H: 22.75" | W: 14" | Ext: 9"  
Backplate: 4" Round  
Socket: 3 - E12 Candelabra | Bulb: 3 - 60 C  
©EFC DESIGNS

**B** **ENTELLINA SCONCE**  
JULIE NEILL

**JN2016**  
H: 27.25" | W: 13.25" | Ext: 9"  
Backplate: 4.5" Round  
Socket: 2 - E12 Candelabra | Bulb: 2 - 40 B

**C** **OSLO SMALL SCONCE**  
E. F. CHAPMAN

**CHD2550**  
H: 16.75" | W: 9.75" | Ext: 7.5"  
Backplate: 4.25" Round  
Socket: 2 - E12 Candelabra | Bulb: 2 - 60 C  
©EFC DESIGNS

**D** **OSLO LARGE SCONCE**  
E. F. CHAPMAN

**CHD2551**  
H: 23.5" | W: 17" | Ext: 11.5"  
Backplate: 4.25" Round  
Socket: 3 - E12 Candelabra | Bulb: 3 - 60 C  
**Additional Options:**  
Gilded Iron | Clear Glass (GI-CG)  
©EFC DESIGNS

opposite page

**E** **MILAN DOUBLE SCONCE**  
NIERMANN WEEKS

**NW2030**  
H: 28" | W: 18" | Ext: 9"  
Backplate: 5" Round  
Socket: 2 - E12 Candelabra | Bulb: 2 - 60 C

**C** **CHD2550BSL-CG**  
Burnished Silver Leaf | Clear Glass



**C** **CHD2550GI-CG**  
Gilded Iron | Clear Glass



**D** **CHD2551BSL-CG**  
Burnished Silver Leaf | Clear Glass



**D** **CHD2551GI-CG**  
Gilded Iron | Clear Glass



**D** **CHD2551BSL-CG**  
Burnished Silver Leaf | Clear Glass



**E** **NW2030VS**  
Venetian Silver | Crystal



**E** **NW2030VG**  
Venetian Gold | Crystal



B TOB2236GI  
Gilded Iron | Quartz



A ELIZABETH SINGLE SCONCE  
THOMAS O'BRIEN

TOB2235  
H: 16.75" | W: 4.5" | Ext: 8"  
Backplate: 4.5" x 6.5" Oval  
Socket: E12 Candelabra | Bulb: 60 C

B ELIZABETH DOUBLE SCONCE  
THOMAS O'BRIEN

TOB2236  
H: 14.5" | W: 9.5" | Ext: 7.25"  
Backplate: 4.5" x 6.5" Oval  
Socket: 2 - E12 Candelabra | Bulb: 2 - 60 C

C ELIZABETH WALL SCONCE  
THOMAS O'BRIEN

TOB2237  
H: 14.75" | W: 5" | Ext: 7.75"  
Backplate: 5" x 12" Rec.  
Socket: E12 Candelabra | Bulb: 60 C

D YVES CRYSTAL SINGLE SCONCE  
THOMAS O'BRIEN

TOB2470  
H: 19" | W: 5" | Ext: 9"  
Backplate: 3.5" x 8.75" Decorative  
Socket: E12 Candelabra | Bulb: 40 C  
Shade: 3" x 5" x 6"  
\* French Wired

E YVES CRYSTAL DOUBLE SCONCE  
THOMAS O'BRIEN

TOB2471  
H: 19" | W: 11.5" | Ext: 9"  
Backplate: 4" x 8.75" Decorative  
Socket: 2 - E12 Candelabra | Bulb: 2 - 40 C  
Shade: 3" x 5" x 6"  
\* French Wired

A TOB2235BSL  
Burnished Silver Leaf | Quartz



A TOB2235GI  
Gilded Iron | Quartz



C TOB2237BSL  
Burnished Silver Leaf | Quartz | Antique Mirror



C TOB2237GI  
Gilded Iron | Quartz | Antique Mirror



B TOB2236BSL  
Burnished Silver Leaf | Quartz



B TOB2236GI  
Gilded Iron | Quartz



D TOB2470GI/CG-PL  
Gilded Iron | Crystal | Percalé



E TOB2471GI/CG-PL  
Gilded Iron | Crystal | Percalé



**A** **SP2013PN**  
Polished Nickel | Crystal



**A** **SP2013HAB**  
Hand-Rubbed Antique Brass | Crystal



**A** **HUNTINGDON DOUBLE SCONCE**  
J. RANDALL POWERS

**SP2013**  
H: 9.5" | W: 10.25" | Ext: 4"  
Backplate: 4.25" Round  
Socket: 2 - E12 Candelabra | Bulb: 2 - 60 C

**B** **PENHURST SCONCE**  
E. F. CHAPMAN

**CHD1555**  
H: 19" | W: 12" | Ext: 7"  
Backplate: 4.5" Round  
Socket: 2 - E12 Candelabra | Bulb: 2 - 60 C  
\* French Wired  
©EFC DESIGNS

**D** **CHD1155CG/PN**  
Crystal | Polished Nickel



**C** **CHD1156CG/PN**  
Crystal | Polished Nickel



**B** **CHD1555PN-CG**  
Polished Nickel | Clear Glass



**B** **CHD1555GI-CG**  
Gilded Iron | Clear Glass



opposite page

**C** **GEORGE II SINGLE SCONCE**  
E. F. CHAPMAN

**CHD1156**  
H: 12" | W: 4.5" | Ext: 8.25"  
Backplate: 4.5" Round  
Socket: E12 Candelabra | Bulb: 60 C  
\* Assembly Required  
©EFC DESIGNS

**D** **GEORGE II DOUBLE SCONCE**  
E. F. CHAPMAN

**CHD1155**  
H: 12" | W: 11.5" | Ext: 7"  
Backplate: 4.5" Round  
Socket: 2 - E12 Candelabra | Bulb: 2 - 60 C  
\* Assembly Required  
©EFC DESIGNS

**D** **CHD1155CG/PN**  
Crystal | Polished Nickel





<p><b>A</b> <b>TOB2032PN-NP</b> Polished Nickel   Natural Paper</p>	<p><b>A</b> <b>TOB2032HAB-NP</b> Hand-Rubbed Antique Brass   Natural Paper</p>	<p><b>B</b> <b>TOB2033PN-NP</b> Polished Nickel   Natural Paper</p>	<p><b>B</b> <b>TOB2033HAB-NP</b> Hand-Rubbed Antique Brass   Natural Paper</p>
---	--	---	--



<p><b>C</b> <b>JN2030CG/PN-L</b> Crystal   Polished Nickel   Linen</p>	<p><b>C</b> <b>JN2030CG/AB-L</b> Crystal   Antique-Burnished Brass   Linen</p>	<p><b>D</b> <b>KW2404CRB/PN</b> Clear Ribbed Glass   Nickel</p>	<p><b>D</b> <b>KW2404CRB/AB</b> Clear Ribbed Glass   Brass</p>
--	--	---	--



**A VIVIAN SINGLE SCONCE**  
THOMAS O'BRIEN

**TOB2032**  
H: 13.5" | W: 4" | Ext: 8.5"  
Backplate: 4" x 5.25" Rec.  
Socket: E12 Candelabra | Bulb: 40 B  
Shade: 3.25" x 4" x 4.25"

**B VIVIAN DOUBLE SCONCE**  
THOMAS O'BRIEN

**TOB2033**  
H: 13.5" | W: 13.5" | Ext: 8.5"  
Backplate: 4" x 5.25" Rec.  
Socket: 2 - E12 Candelabra | Bulb: 2 - 40 B  
Shade: 3.25" x 4" x 4.25"  
**Additional Options:**  
Polished Nickel | Natural Paper (PN-NP)  
©EFC DESIGNS

**C CLARICE DOUBLE SCONCE**  
JULIE NEILL

**JN2030**  
H: 15.75" | W: 17.5" | Ext: 11.25"  
Backplate: 4.25" x 7.75" Oval  
Socket: 2 - E12 Candelabra  
Bulb: 2 - 40 B  
Shade: 4.25" x 5" x 6"

**D REVERIE DOUBLE SCONCE**  
KELLY WEARSTLER

**KW2404**  
H: 19" | W: 14" | Ext: 7.75"  
Backplate: 4" x 9" Rec.  
Socket: 2 - E12 Candelabra | Bulb: 2 - 40 B  
**Additional Options:**  
Clear Ribbed Glass | Bronze (CRB/BZ)

<p><b>B</b> <b>TOB2033HAB-NP</b> Hand-Rubbed Antique Brass   Natural Paper</p>
--



**A** SK2016HAB-NP  
Hand-Rubbed Antique Brass | Natural Paper

**A** CAMILLE SCONCE  
SUZANNE KASLER

**SK2016**  
H: 19" | W: 5.5" | Ext: 6"  
Backplate: 4.5" Round  
Socket: E12 Candelabra | Bulb: 40 B  
Shade: 4" x 5.5" x 5.5"

**A** SK2016PN-NP  
Polished Nickel | Natural Paper

**A** SK2016AN-NP  
Antique Nickel | Natural Paper

**A** SK2016HAB-NP  
Hand-Rubbed Antique Brass | Natural Paper

**A** SK2016BZ-NP  
Bronze | Natural Paper

**B** CAMILLE LARGE TAIL SCONCE  
SUZANNE KASLER

**SK2017**  
H: 29" | W: 7.5" | Ext: 8"  
Backplate: 5" Round  
Socket: E26 Keyless | Bulb: 60 A  
Shade: 6" x 7.5" x 7.25"

**B** SK2017PN-NP  
Polished Nickel | Natural Paper

**B** SK2017AN-NP  
Antique Nickel | Natural Paper

**B** SK2017HAB-NP  
Hand-Rubbed Antique Brass | Natural Paper

**B** SK2017BZ-NP  
Bronze | Natural Paper



**A** **SK2902PN/Q-L**  
Polished Nickel | Quartz | Linen



**A** **SK2902AB/Q-L**  
Antique-Burnished Brass | Quartz | Linen



**A** **ADALINE SMALL TAIL SCONCE**  
SUZANNE KASLER

**SK2902**  
H: 15" | W: 7.5" | Ext: 3.75"  
Backplate: 2.5" x 3.75" Rec.  
Socket: E12 Candelabra | Bulb: 40 B  
Shade: 7.5" x 7.5" x 4.75"

**B** **ADALINE MEDIUM TAIL SCONCE**  
SUZANNE KASLER

**SK2904**  
H: 22.25" | W: 10" | Ext: 6.5"  
Backplate: 4.5" x 5" Rec.  
Socket: E26 Keyless | Bulb: 40 A  
Shade: 10" x 10" x 6.75"

**C** **TOB2916PN/CG-PL**  
Polished Nickel | Crystal | Natural Percale



**D** **CHD2712PN/CG-S**  
Polished Nickel | Crystal | Silk



**D** **CHD2712AB/CG-S**  
Antique-Burnished Brass | Crystal | Silk



**D** **EDGAR MEDIUM SCONCE**  
E. F. CHAPMAN

**CHD2712**  
H: 18.75" | W: 7" | Ext: 5.75"  
Backplate: 4.25" Square  
Socket: E26 Keyless | Bulb: 60 A  
Shade: 6" x 7" x 7.5" Rec. Shield  
©EFC DESIGNS

**E** **EDGAR LARGE SCONCE**  
E. F. CHAPMAN

**CHD2713**  
H: 26.25" | W: 8" | Ext: 5.75"  
Backplate: 4.25" Square  
Socket: E26 Keyless | Bulb: 60 A  
Shade: 6.5" x 8" x 8.25" Rec. Shield  
©EFC DESIGNS

**F** **CHD2957CG/PN-S**  
Crystal | Polished Nickel | Silk



**B** **SK2904PN/Q-L**  
Polished Nickel | Quartz | Linen



**B** **SK2904AB/Q-L**  
Antique-Burnished Brass | Quartz | Linen



**C** **MOREAU LARGE SCONCE**  
THOMAS O'BRIEN

**TOB2916**  
H: 22.5" | W: 9.5" | Ext: 8.5"  
Backplate: 4" x 5.5" Rec.  
Socket: E26 Keyless | Bulb: 60 A  
Shade: 8.5" x 9.5" x 10.5" Square Shield



**C** **TOB2916HAB/CG-PL**  
Hand-Rubbed Antique Brass | Crystal | Natural Percale



**E** **CHD2713PN/CG-S**  
Polished Nickel | Crystal | Silk



**E** **CHD2713AB/CG-S**  
Antique-Burnished Brass | Crystal | Silk



**F** **EDWIN DOUBLE ARM SCONCE**  
E. F. CHAPMAN

**CHD2957**  
H: 19" | W: 13.5" | Ext: 6.5"  
Backplate: 4" Square  
Socket: 2 - E12 Candelabra | Bulb: 2 - 40 C  
Shade: 12" x 13.5" x 7.5" Shield  
©EFC DESIGNS



**F** **CHD2957CG/AB-S**  
Crystal | Brass | Silk





**B** | **CHD2262CG/AB-PL**  
Crystal | Brass | Percalé

**A HENRI FRAMED JEWEL SCONCE**  
SUZANNE KASLER

**SK2030**  
H: 15.25" | W: 9.5" | Ext: 5.25"  
Backplate: 4.5" x 5" Rec.  
Socket: E26 Keyless | Bulb: 40 A  
Shade: 7.5" x 9.5" x 7.75" Rec. Shield

**B AMBAR TALL WALL LIGHT**  
IAN K. FOWLER

**S2944**  
H: 10.25" | W: 4.25" | Ext: 3.75"  
Backplate: 4.25" x 6.25" Rec.  
Socket: E12 Candelabra | Bulb: 40 T

**C PALADIN TALL OBELISK SCONCE**  
E. F. CHAPMAN

**CHD2262**  
H: 25" | W: 11" | Ext: 5.75"  
Backplate: 5" x 23.25" Rec.  
Socket: E12 Candelabra | Bulb: 60 B  
Shade: 11" x 11" x 8" Shield  
©EFC DESIGNS

**D AMBAR SMALL WALL LIGHT**  
IAN K. FOWLER

**S2945**  
H: 7.75" | W: 7" | Ext: 4"  
Backplate: 4.75" x 6.25" Square  
Socket: E12 Candelabra | Bulb: 40 T

**A** | **SK2030CG/PN-L**  
Crystal | Polished Nickel | Linen



**A** | **SK2030CG/HAB-L**  
Crystal | Hand-Rubbed Antique Brass | Linen



**B** | **S2944CG/PN**  
Crystal | Polished Nickel



**B** | **S2944CG/HAB**  
Crystal | Hand-Rubbed Antique Brass



**C** | **CHD2262CG/PN-PL**  
Crystal | Polished Nickel | Percalé



**C** | **CHD2262CG/AB-PL**  
Crystal | Brass | Percalé

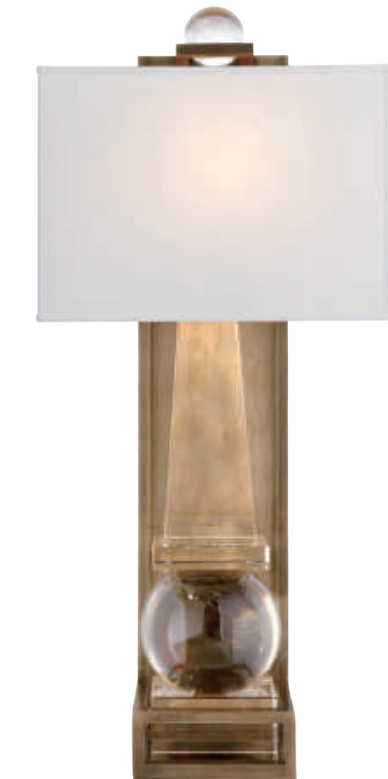

**D** | **S2945CG/PN**  
Crystal | Polished Nickel



**D** | **S2945CG/HAB**  
Crystal | Hand-Rubbed Antique Brass





opposite page

**A ALPINE SMALL SINGLE SCONCE**  
AERIN

**ARN2309**  
H: 11" | W: 4.5" | Ext: 6.25"  
Backplate: 4.25" Square  
Socket: E12 Candelabra | Bulb: 60 C  
**Additional Options:**  
Hand-Rubbed Antique Brass | Clear Glass (HAB-CG)  
Polished Nickel | White Glass (PN-WG)

**B DEAUVILLE SINGLE SCONCE**  
AERIN

**ARN2010**  
H: 14.5" | W: 5.25" | Ext: 7"  
Backplate: 4.25" x 14.5" Rec.  
Socket: E12 Candelabra | Bulb: 60 C

**C ALPINE SINGLE SCONCE**  
AERIN

**ARN2310**  
H: 16.25" | W: 5.25" | Ext: 7.75"  
Backplate: 4.25" x 7" Rec.  
Socket: 2 - E12 Candelabra | Bulb: 2 - 60 C  
**Additional Options:**  
Polished Nickel | Clear Glass (PN-WG)  
Hand-Rubbed Antique Brass | Clear Glass (HAB-CG)

**D PRESIDIO SMALL SCONCE**  
IAN K. FOWLER

**S2167**  
H: 14.5" | W: 8" | Ext: 7"  
Backplate: 5.5" x 14.25" Rec.  
Socket: E26 Keyless | Bulb: 60 T

**E PRESCOTT LEFT SCONCE**  
kate spade new york

**KS2407**  
H: 20.5" | W: 12" | Ext: 7"  
Backplate: 3" x 5" Rec.  
Socket: 2 - E12 Candelabra | Bulb: 2 - 40 G  
**Additional Options:**  
Soft Brass | White Glass (SB-WG)  
\* Requires Smaller Outlet Box

**F PRESCOTT RIGHT SCONCE**  
kate spade new york

**KS2408**  
H: 20.5" | W: 12" | Ext: 7"  
Backplate: 3" x 5" Rec.  
Socket: 2 - E12 Candelabra | Bulb: 2 - 40 G  
**Additional Options:**  
Polished Nickel | White Glass (PN-WG)  
\* Requires Smaller Outlet Box

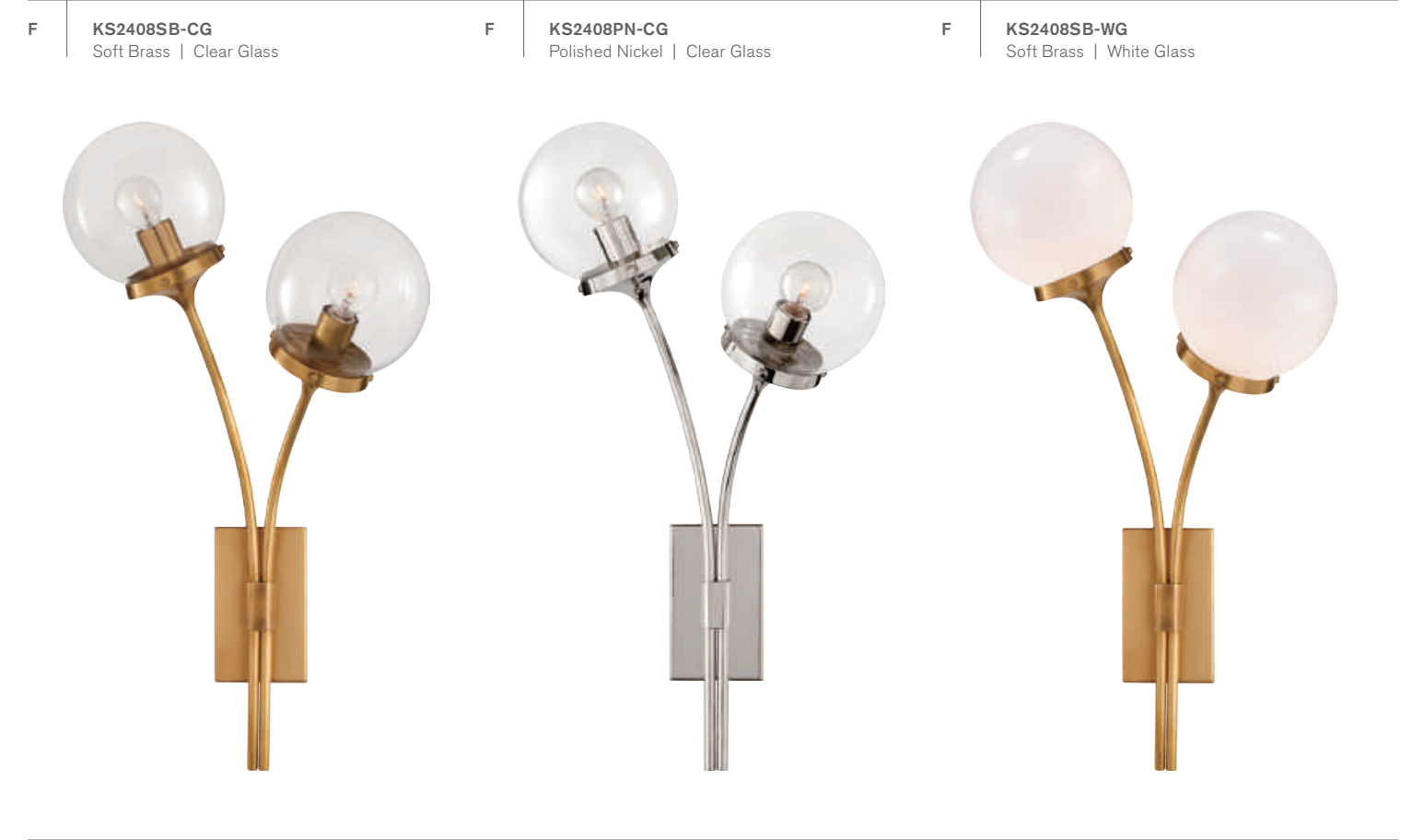
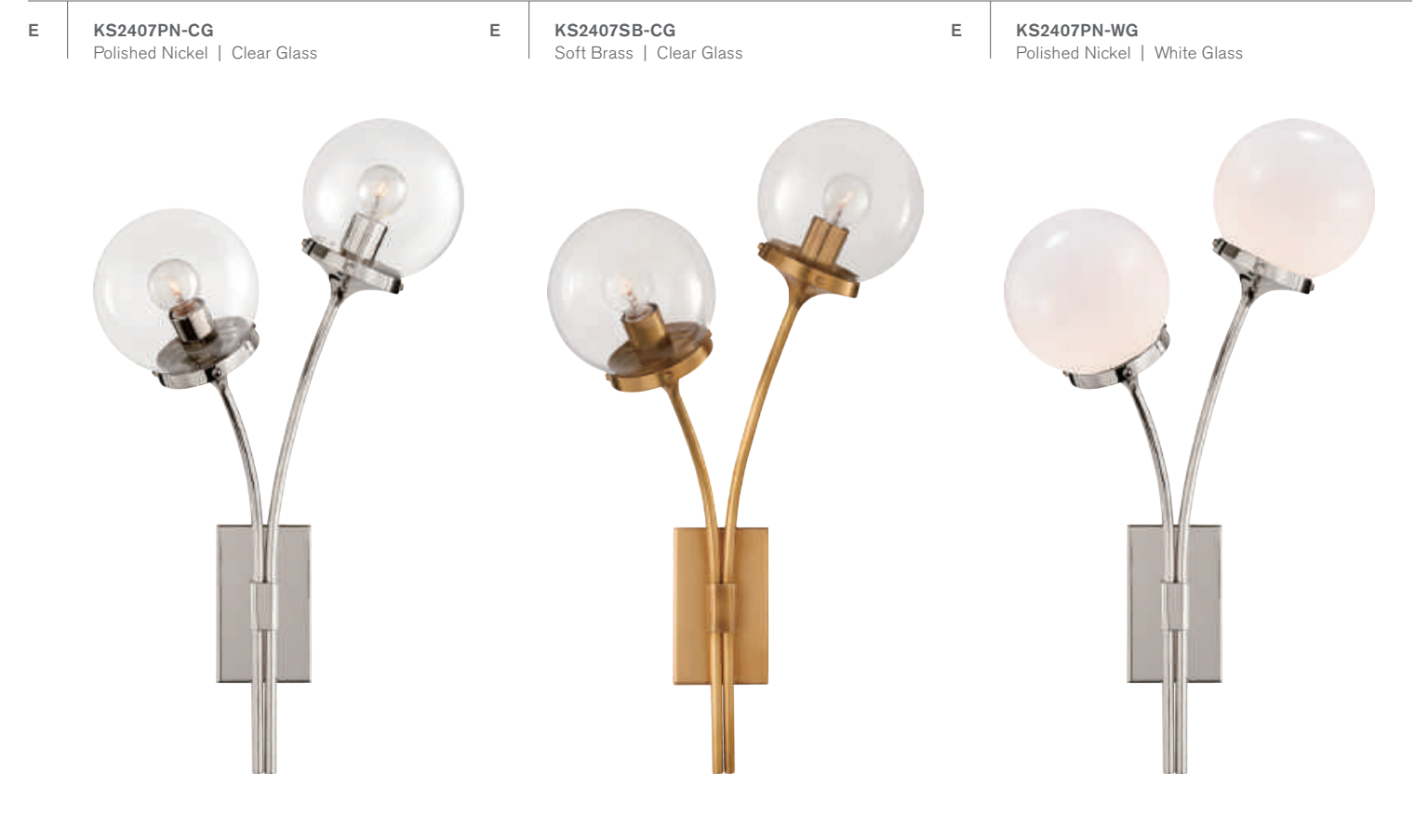

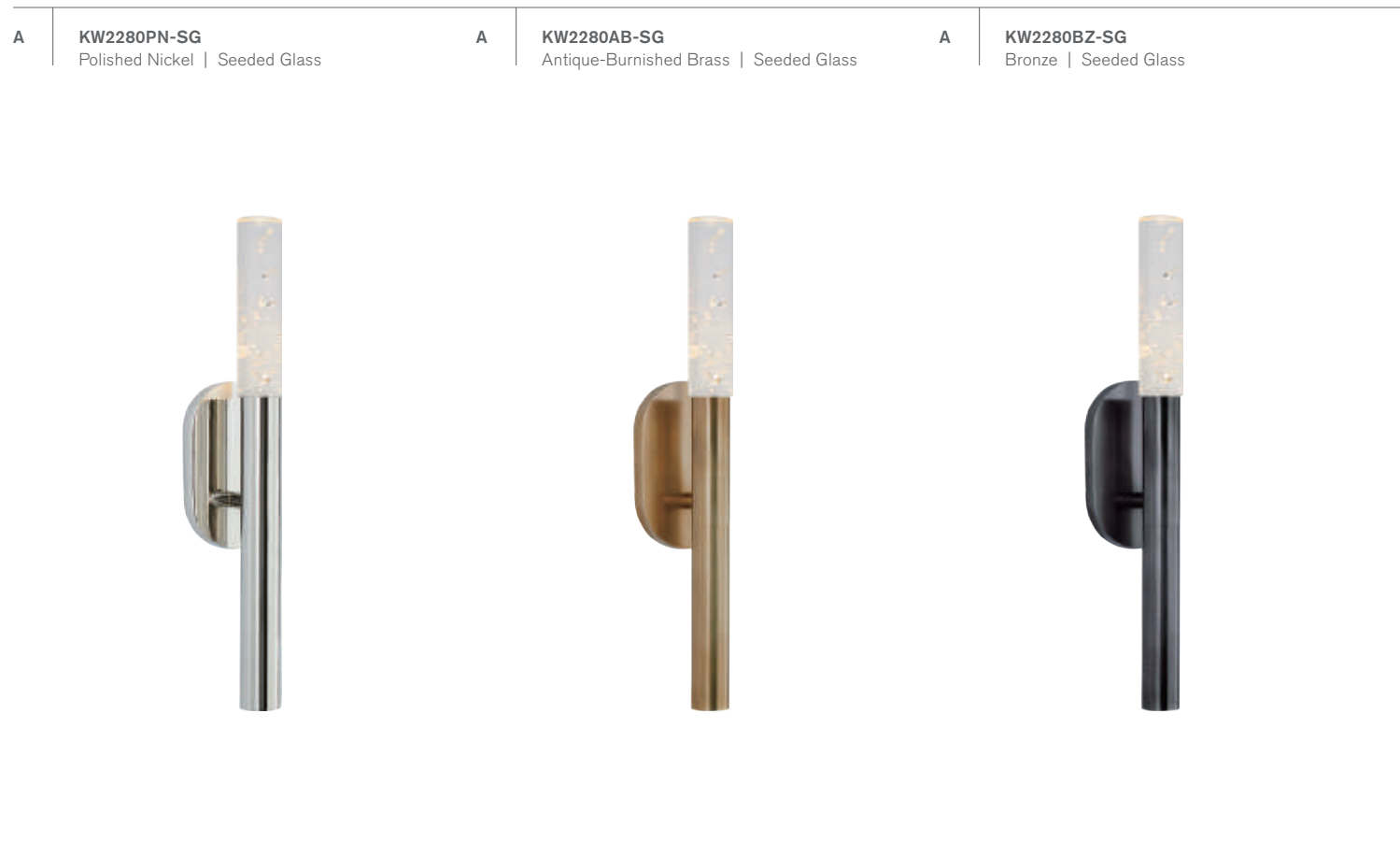

**A** | **ROUSSEAU SMALL BATH SCONCE**  
KELLY WEARSTLER

**KW2280**  
H: 14.5" | W: 3" | Ext: 2.75"  
Backplate: 3" x 5" Oval | LED: 5w  
**Additional Options:**  
Antique-Burnished Brass | Etched Crystal (AB-EC)  
Bronze | Etched Crystal (BZ-EC)  
Polished Nickel | Etched Crystal (PN-EC)  
\* Requires Smaller Outlet Box

**B** | **ROUSSEAU MEDIUM BATH SCONCE**  
KELLY WEARSTLER

**KW2281**  
H: 20" | W: 4.25" | Ext: 2.75"  
Backplate: 4.25" x 9.5" Oval | LED: 5w  
**Additional Options:**  
Antique-Burnished Brass | Seeded Glass (AB-SG)  
Bronze | Seeded Glass (BZ-SG)  
Polished Nickel | Seeded Glass (PN-SG)

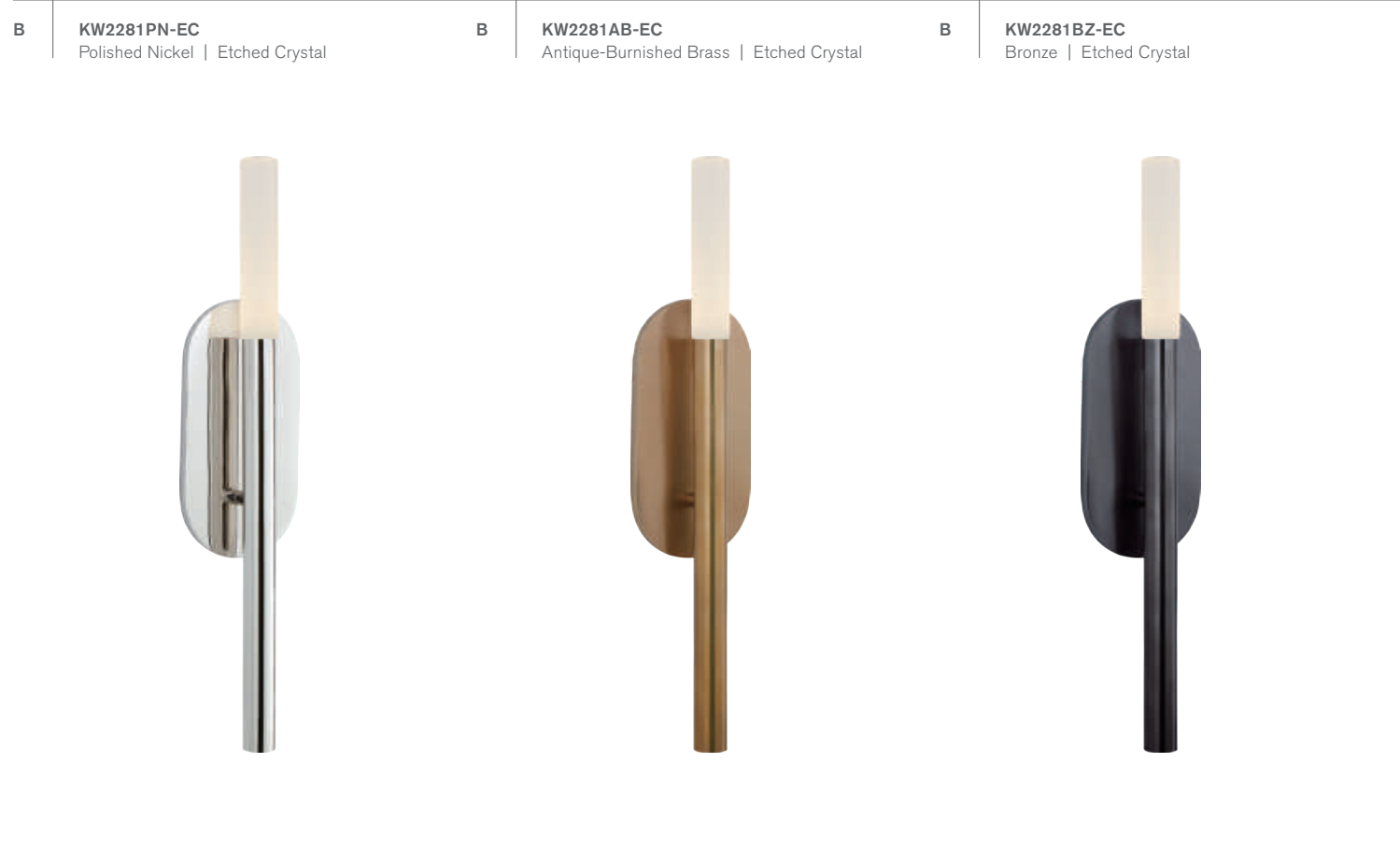

opposite page

**C** | **ROUSSEAU MEDIUM VANITY SCONCE**  
KELLY WEARSTLER

**KW2282**  
H: 22" | W: 4.25" | Ext: 2.75"  
Backplate: 4.25" x 9.5" Oval  
LED: 10w  
**Additional Options:**  
Antique-Burnished Brass | Seeded Glass (AB-SG)  
Polished Nickel | Etched Crystal (PN-EC)

**D** | **ROUSSEAU DOUBLE WALL SCONCE**  
KELLY WEARSTLER

**KW2283**  
H: 20.25" | W: 10" | Ext: 5.75"  
Backplate: 4.25" x 9.5" Oval  
LED: 10w  
**Additional Options:**  
Antique-Burnished Brass | Seeded Glass (AB-SG)  
Bronze | Seeded Glass (BZ-SG)  
Polished Nickel | Seeded Glass (PN-SG)

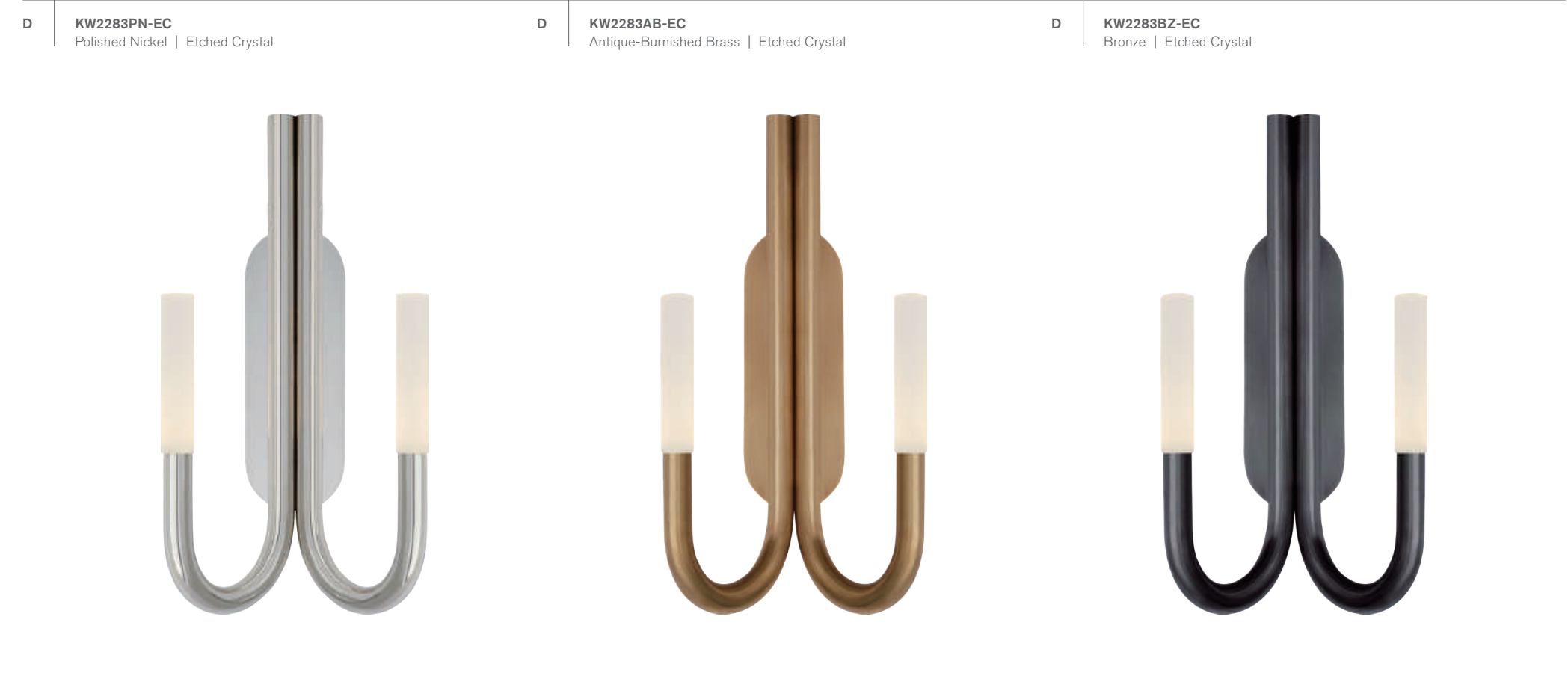
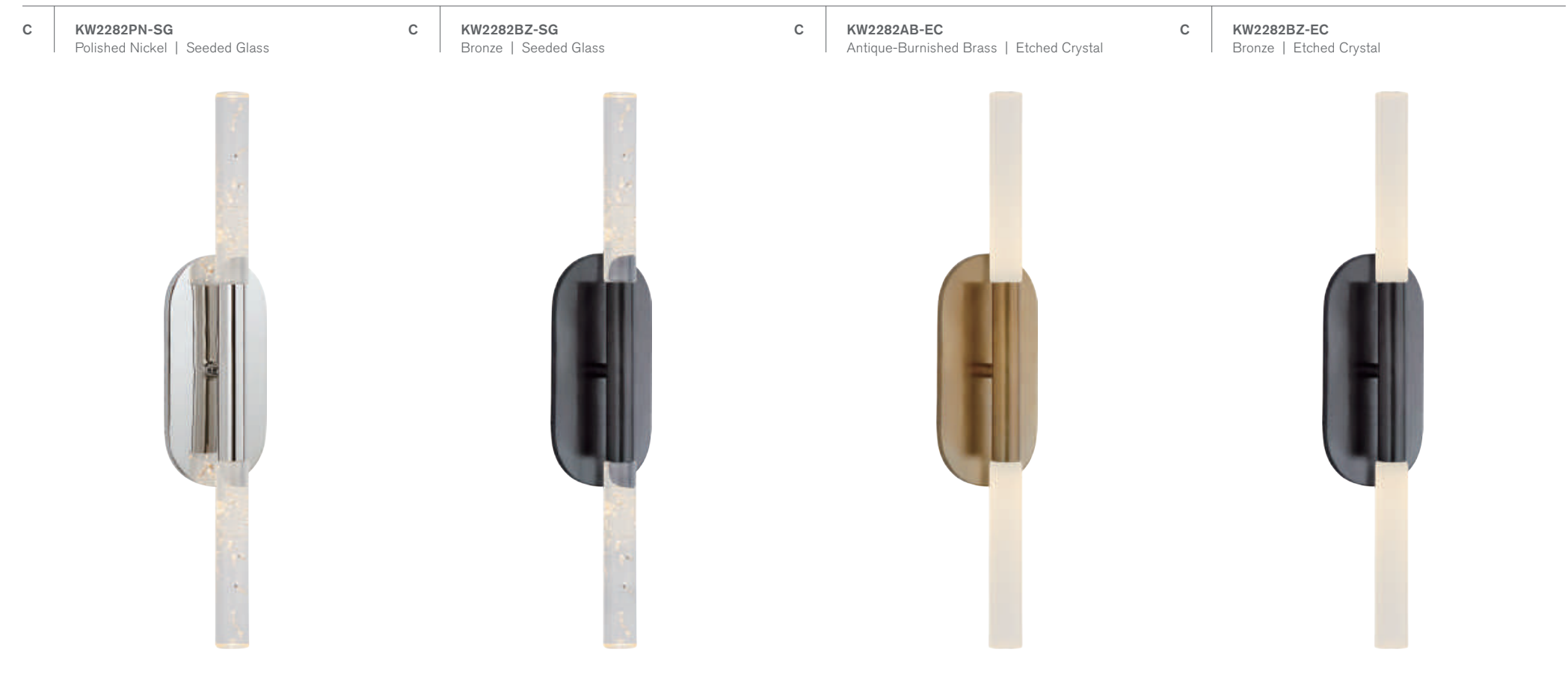

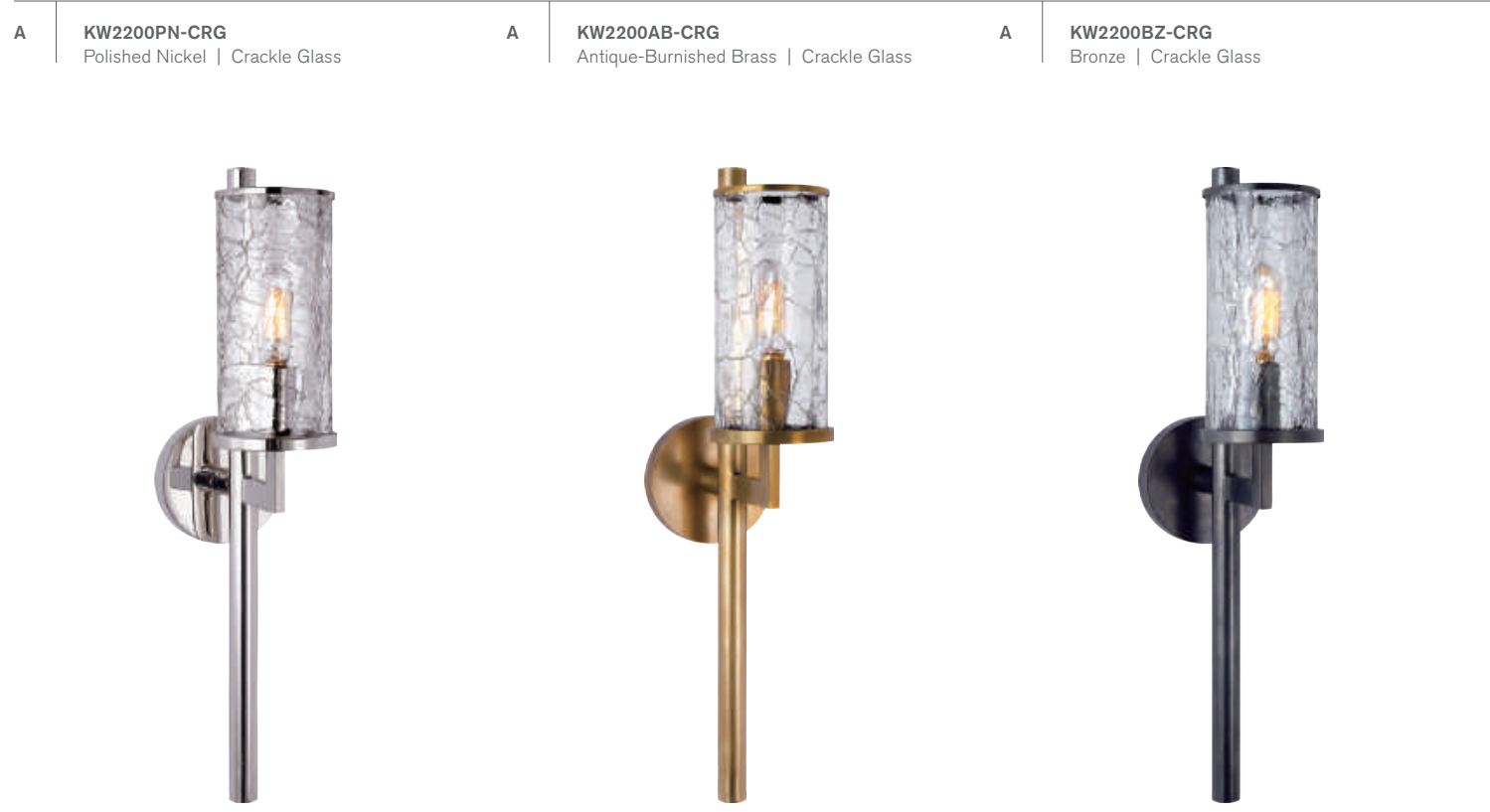

**A LIAISON SINGLE ARM SCONCE**  
KELLY WEARSTLER

**KW2200**  
H: 19" | W: 4" | Ext: 7.5"  
Backplate: 4" Round  
Socket: E12 Candelabra | Bulb: 60 C  
\* Requires Smaller Outlet Box

**B LIAISON DOUBLE ARM SCONCE**  
KELLY WEARSTLER

**KW2201**  
H: 19" | W: 9.5" | Ext: 5.25"  
Backplate: 4" Round  
Socket: 2 - E12 Candelabra | Bulb: 2 - 60 C  
\* Requires Smaller Outlet Box

**C KW2204AB-CRG**  
Antique-Burnished Brass | Crackle Glass



opposite page

**C LIAISON STATEMENT SCONCE**  
KELLY WEARSTLER

**KW2204**  
H: 84.25" | W: 12.75" | Ext: 5.25"  
Backplate: 4" Round  
Socket: 8 - E12 Candelabra | Bulb: 8 - 60 C  
**Additional Options:**  
Bronze | Crackle Glass (BZ-CRG)  
Polished Nickel | Crackle Glass (PN-CRG)  
\* Requires Smaller Outlet Box

**D VIVIER SINGLE SCONCE**  
THOMAS O'BRIEN

**TOB2502**  
H: 20" | W: 6.5" | Ext: 6.75"  
Backplate: 5" Round  
Socket: E12 Candelabra | Bulb: 40 B

**E VIVIER DOUBLE SCONCE**  
THOMAS O'BRIEN

**TOB2503**  
H: 20" | W: 13.5" | Ext: 6.25"  
Backplate: 5" Round  
Socket: 2 - E12 Candelabra | Bulb: 2 - 40 B

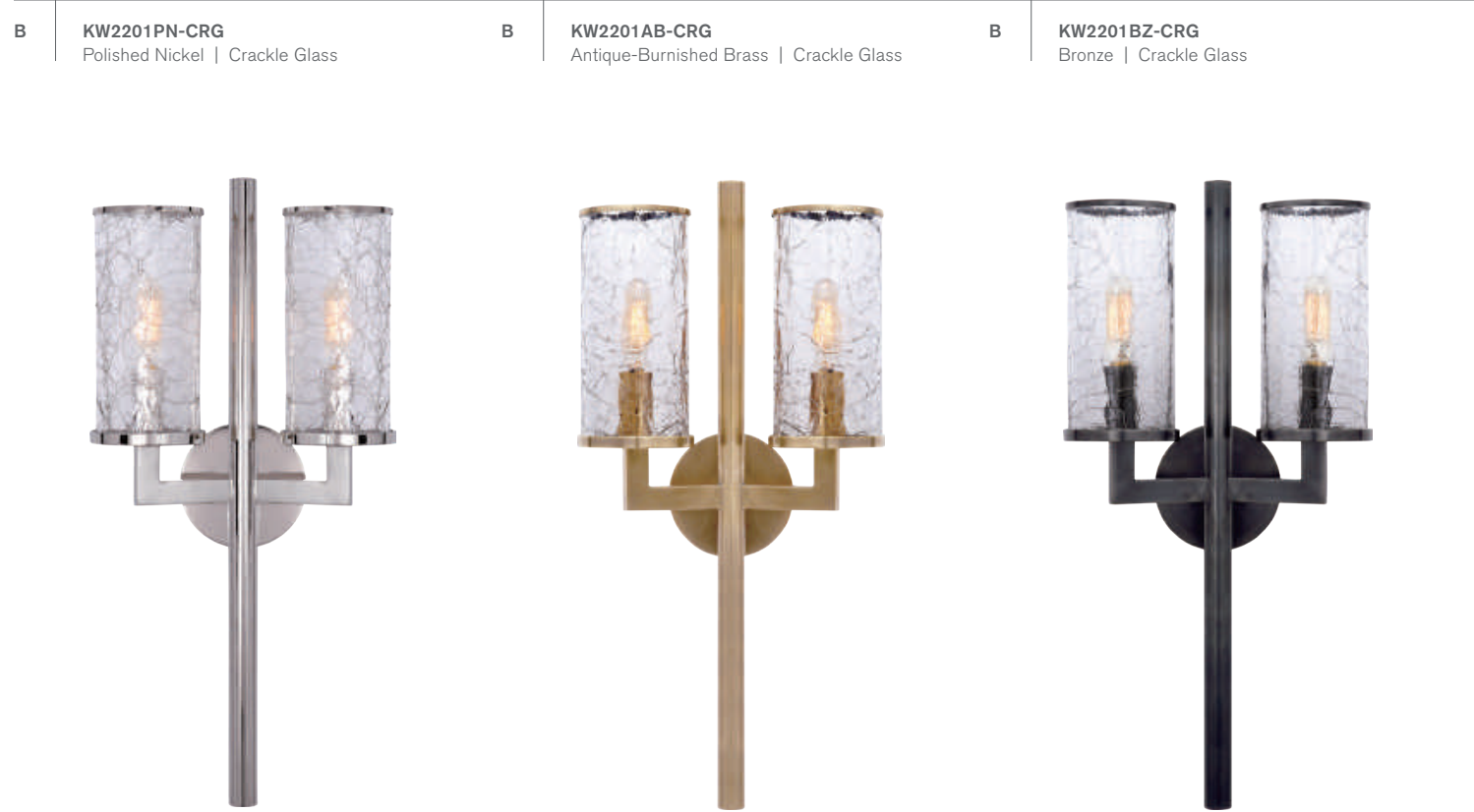

**D TOB2502BK/HAB-CG2**  
Blackened Iron | Brass | Cylinder Clear Glass



**E TOB2503BK/HAB-CG2**  
Blackened Iron | Brass | Cylinder Clear Glass



**A** **KS2120SB/CRE-L/SB**  
Soft Brass | Cream | Cream Linen



**A** **KS2120SB/BLK-L/SB**  
Soft Brass | Black | Cream Linen



**A** **BRADFORD MEDIUM SCONCE**  
kate spade new york  
**KS2120**  
H: 14.5" | W: 6.5" | Ext: 8.75"  
Backplate: 4.5" Square  
Socket: E12 Candelabra | Bulb: 60 B  
Shade: 5.25" x 6.5" x 6"

**B** **KS2008PN-L**  
Polished Nickel | Linen



**C** **KS2117SB-L**  
Soft Brass | Mirror | Linen



**B** **KS2008SB-B**  
Soft Brass | Matte Black



**A** **KS2120PN/MIR-L/PN**  
Polished Nickel | Mirror | Cream Linen



**A** **KS2120SB/MIR-L/SB**  
Soft Brass | Mirror | Cream Linen



**B** **KS2008SB-L**  
Soft Brass | Linen



**B** **ELLERY GROS-GRAIN BOW SMALL SCONCE**  
kate spade new york  
**KS2008**  
H: 13.5" | W: 5" | Ext: 5.375"  
Backplate: 4" Square  
Socket: E12 Candelabra | Bulb: 60 B  
Shade: 4.25" x 5" x 5.5" Square Shield

**C** **ELLERY GROS-GRAIN BOW TAIL SCONCE**  
kate spade new york  
**KS2117**  
H: 36" | W: 7" | Ext: 6.5"  
Backplate: 3.25" Square  
Socket: E12 Candelabra | Bulb: 40 B  
Shade: 5.75" x 7" x 9.25" Square Shield  
**Additional Options:**  
Soft Brass | Mirror | Matte Black (SB-B)  
Polished Nickel | Mirror | Linen (PN-L)





**A** | **S2177PN-PL**  
Polished Nickel | Percalé



**B** | **S2320PN-NP**  
Polished Nickel | Natural Paper



**A** | **S2177HAB-PL**  
Hand-Rubbed Antique Brass | Percalé



opposite page

**A** | **GRENOL SINGLE BAMBOO SCONCE**  
STUDIO VC

**S2177**  
H: 17.75" | W: 5" | Ext: 5"  
Backplate: 3.5" x 5.5" Rec.  
Socket: E12 Candelabra | Bulb: 40 B  
Shade: 4" x 5" x 6.75"  
**Additional Options:**  
Bronze | Percalé (BZ-PL)  
\* Requires Smaller Outlet Box

**B** | **S2320PN-NP**  
Polished Nickel | Natural Paper



**B** | **S2320GI-NP**  
Gilded Iron | Natural Paper



**B** | **S2320AI-NP**  
Aged Iron | Natural Paper



**C** | **S2321PN-NP**  
Polished Nickel | Natural Paper



**C** | **S2321GI-NP**  
Gilded Iron | Natural Paper

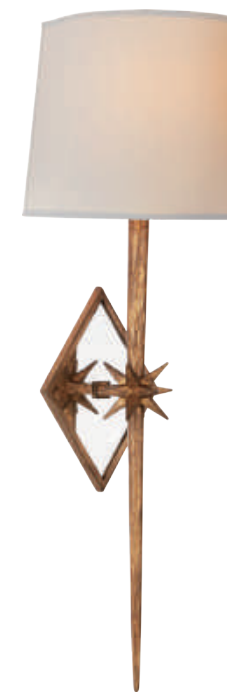

**C** | **S2321AI-NP**  
Aged Iron | Natural Paper



**B** | **ETOILE SINGLE SCONCE**  
IAN K. FOWLER

**S2320**  
H: 16.5" | W: 5.25" | Ext: 5.5"  
Backplate: 4.5" Round  
Socket: E12 Candelabra | Bulb: 40 B  
Shade: 4.5" x 5.25" x 6.25" Shield  
\* Electrical is Behind Shade

**C** | **ETOILE LARGE TAIL SCONCE**  
IAN K. FOWLER

**S2321**  
H: 29.5" | W: 9.5" | Ext: 8"  
Backplate: 5.5" x 9.5" Diamond  
Socket: 2 - E12 Candelabra | Bulb: 2 - 40 B  
Shade: 8" x 9.5" x 8.75" Shield

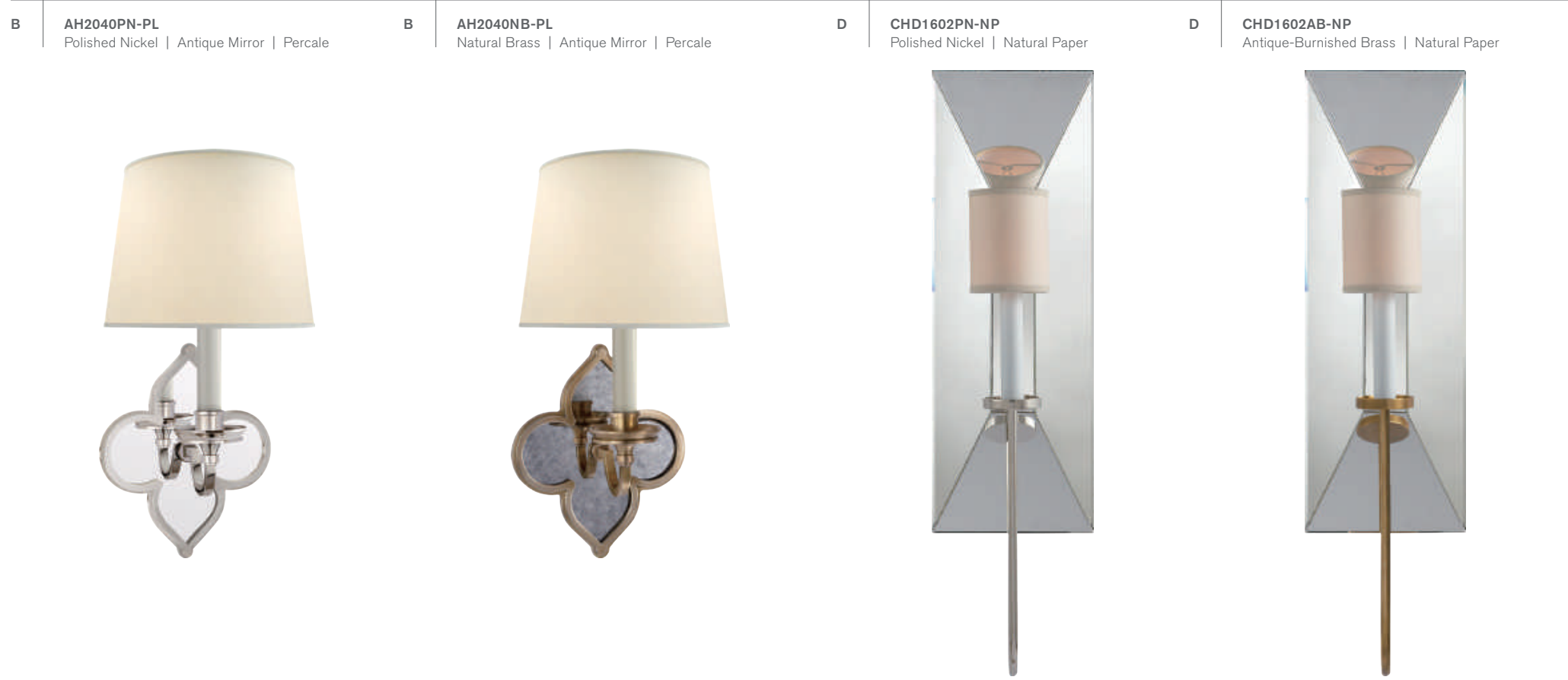

**A VERONA MIRRORED SCONCE**  
THOMAS O'BRIEN

**TOB2330**  
H: 15.75" | W: 5.5" | Ext: 7.5"  
Backplate: 4.5" x 8.5"  
Socket: E12 Candelabra | Bulb: 40 B  
Shade: 3.5" x 5.5" x 6"  
**Additional Options:**  
Sheffield Nickel | Natural Paper (SN-NP)  
Weathered Iron | Natural Paper (WI-NP)

**B LANA SINGLE SCONCE**  
ALEXA HAMPTON

**AH2040**  
H: 13.75" | W: 6.5" | Ext: 6.5"  
Backplate: 4" Round  
Socket: E12 Candelabra | Bulb: 60 B  
Shade: 5" x 6.5" x 5.5"  
**Additional Options:**  
Gun Metal | Antique Mirror | Percalé (GM-PL)

**C COTSWOLD NARROW MIRRORED SCONCE**  
E. F. CHAPMAN

**CHD1601**  
H: 15.5" | W: 4" | Ext: 4"  
Backplate: 3.75" x 11.75" Rec.  
Socket: E12 Candelabra | Bulb: 25 B  
Shade: 3" x 3" x 4"  
©EFC DESIGNS

**D COTSWOLD LARGE MIRRORED SCONCE**  
E. F. CHAPMAN

**CHD1602**  
H: 24.25" | W: 6.5" | Ext: 5.25"  
Backplate: 6.5" x 18.5" Rec.  
Socket: E12 Candelabra | Bulb: 25 B  
Shade: 3" x 3" x 4"  
©EFC DESIGNS



**D CHD1602PN-NP**  
Polished Nickel | Natural Paper

**A** | **LIDO SMALL SCONCE**  
NIERMANN WEEKS

**NW2044**  
H: 16" | W: 6" | Ext: 3.25"  
Backplate: 5.5" x 16" Decorative  
Socket: E12 Candelabra | Bulb: 40 C

**A** | **NW2044AM/HAB**  
Antique Mirror | Hand-Rubbed Antique Brass



**C** | **CHD1184AB**  
Antique-Burnished Brass | Antique Mirror



**B** | **SUSSEX SMALL FRAMED SCONCE**  
E. F. CHAPMAN

**CHD1183**  
H: 12.25" | W: 5" | Ext: 4.25"  
Backplate: 2.25" x 7" Rec.  
Socket: E12 Candelabra | Bulb: 60 C  
©EFC DESIGNS

**C** | **SUSSEX MEDIUM FRAMED DOUBLE SCONCE**  
E. F. CHAPMAN

**CHD1184**  
H: 20.5" | W: 9.5" | Ext: 4.75"  
Backplate: 4.75" x 17" Rec.  
Socket: 2 - E12 Candelabra | Bulb: 2 - 60 C  
©EFC DESIGNS

**B** | **CHD1183PN**  
Polished Nickel | Antique Mirror



**C** | **CHD1184PN**  
Polished Nickel | Antique Mirror



**B** | **CHD1183AB**  
Antique-Burnished Brass | Antique Mirror



**C** | **CHD1184AB**  
Antique-Burnished Brass | Antique Mirror



**B** | **CHD1183SN**  
Sheffield Nickel | Antique Mirror



**C** | **CHD1184SN**  
Sheffield Nickel | Antique Mirror



A

**NW2115PN**  
Polished Nickel | Mirror



A

**NW2115HAB**  
Hand-Rubbed Antique Brass | Antique Mirror



A

**REGENT RECTANGULAR SCONCE**  
NIERMANN WEEKS

**NW2115**  
H: 17.5" | W: 5.5" | Ext: 3.25"  
Backplate: 5.5" x 17.5" Rec.  
Socket: E12 Candelabra | Bulb: 60 C

B

**SP2003AI**  
Aged Iron | Antique Mirror



A

**NW2115AN**  
Antique Nickel | Antique Mirror



A

**NW2115BZ**  
Bronze | Antique Mirror



B

**KATE SMALL REFLECTOR SCONCE**  
J. RANDALL POWERS

**SP2003**  
H: 13.75" | W: 4.5" | Ext: 3"  
Backplate: 4.5" Square  
Socket: E12 Candelabra | Bulb: 60 C

C

**ALICE FRAMED SCONCE**  
SUZANNE KASLER

**SK2002**  
H: 27.25" | W: 11.75" | Ext: 6"  
Backplate: 4" x 5.25" Rec.  
Socket: E12 Candelabra | Bulb: 60 C

C

**SK2002AI**  
Aged Iron | Clear Glass



D

**CHD1186OW**  
Old White | Acrylic Mirror



D

**CHELSEA MEDIUM REFLECTION SCONCE**  
E. F. CHAPMAN

**CHD1186**  
H: 12.25" | W: 10.25" | Ext: 4.5"  
Backplate: 9.5" Round  
Socket: E12 Candelabra | Bulb: 60 C  
©EFC DESIGNS

D

**CHD1186TB**  
Tudor Brown | Acrylic Mirror



A **TOB2221PN-AM**  
Polished Nickel | Antique Mirror

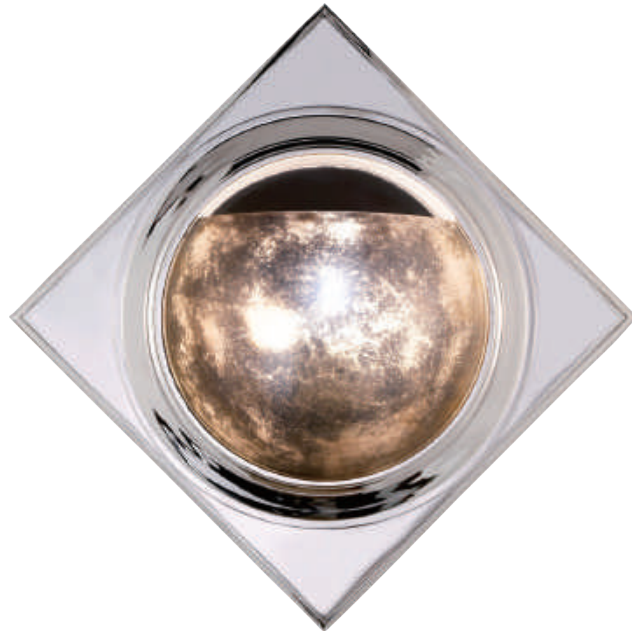

A **TOB2221HAB-AM**  
Hand-Rubbed Antique Brass | Antique Mirror



A **TOB2221BZ-AM**  
Bronze | Antique Mirror



B **TOB2730Q-NP**  
Quartz | Natural Paper



B **TOB2730CG-NP**  
Crystal | Natural Paper



opposite page

A **VENICE SCONCE**  
THOMAS O'BRIEN

**TOB2221**  
H: 12.5" | W: 12.5" | Ext: 4"  
Backplate: 8.75" Square  
Socket: E12 Candelabra | Bulb: 60 B

C **TOB2242HAB/ALB-L**  
Hand-Rubbed Antique Brass | Alabaster | Linen



B **TOB2730HAB-NP**  
Hand-Rubbed Antique Brass | Natural Paper



B **TOB2730SHS-NP**  
Sheffield Silver | Natural Paper



B **JONATHAN SCONCE**  
THOMAS O'BRIEN

**TOB2730**  
H: 13.5" | W: 6" | Ext: 7"  
Backplate: 5" Round  
Socket: E26 Keyless | Bulb: 60 A  
Shade: 4" x 6" x 6"

C **CASPER SMALL SCONCE**  
THOMAS O'BRIEN

**TOB2242**  
H: 10" | W: 6" | Ext: 7"  
Backplate: 4.25" x 7.75" Oval  
Socket: E12 Candelabra | Bulb: 40 B  
Shade: 6" x 6" x 6" Oval

C **TOB2242BZ/ALB-L**  
Bronze | Alabaster | Linen



A **NW2311VS**  
Venetian Silver | Antique Mirror



A **NW2311VG**  
Venetian Gold | Antique Mirror



B **CHD4175GI**  
Gilded Iron | Antique Mirror



C **ARN2000PW-WG**  
Plaster White | White Glass



C **ARN2000BSL-WG**  
Burnished Silver Leaf | White Glass



C **ARN2000G-WG**  
Gild | White Glass



C **ARN2000BZ-WG**  
Bronze | White Glass



opposite page

A **BRITTANY DOUBLE SCONCE**  
NIERMANN WEEKS

**NW2311**  
H: 15.75" | W: 5.75" | Ext: 3"  
Backplate: 5" x 15.75" Decorative  
Socket: 2 - E12 Candelabra | Bulb: 2 - 60 C  
**Additional Options:**  
Aged Iron | Antique Mirror (AI)

B **GRAMERCY DOUBLE SCONCE**  
E. F. CHAPMAN

**CHD4175**  
H: 15.75" | W: 12.5" | Ext: 7.75"  
Backplate: 6.75" Round  
Socket: 2 - E12 Candelabra | Bulb: 2 - 60 C  
©EFC DESIGNS

D **CHD2470GI**  
Gilded Iron



D **CHD2470AI**  
Aged Iron



C **EDGEMERE SINGLE SCONCE**  
AERIN

**ARN2000**  
H: 16" | W: 4.5" | Ext: 8.5"  
Backplate: 4.25" Round  
Socket: E12 Candelabra | Bulb: 60 B

D **BRANCH SCONCE**  
E. F. CHAPMAN

**CHD2470**  
H: 22.75" | W: 15" | Ext: 6.5"  
Backplate: 4.25" Round  
Socket: 2 - E12 Candelabra | Bulb: 2 - 60 C  
**Additional Options:**  
Old White (OW)  
\* French Wired  
©EFC DESIGNS

A

**JN2070PW**  
Plaster White



A

**JN2070AGL**  
Antique Gold Leaf



A

**MANDEVILLE SCONCE**  
JULIE NEILL

**JN2070**  
H: 15" | W: 13.75" | Ext: 5.25"  
Backplate: 4.5" Round  
Socket: 2 - E12 Candelabra | Bulb: 2 - 60 G

B

**ALBERTO MEDIUM SCONCE**  
JULIE NEILL

**JN2002**  
H: 21" | W: 6.25" | Ext: 7.75"  
Backplate: 2.75" x 4.75" Rec.  
Socket: E12 Candelabra | Bulb: 60 G  
\* Requires Smaller Outlet Box

C

**ARN2001G**  
Gild



C

**ARN2001PW**  
Plaster White

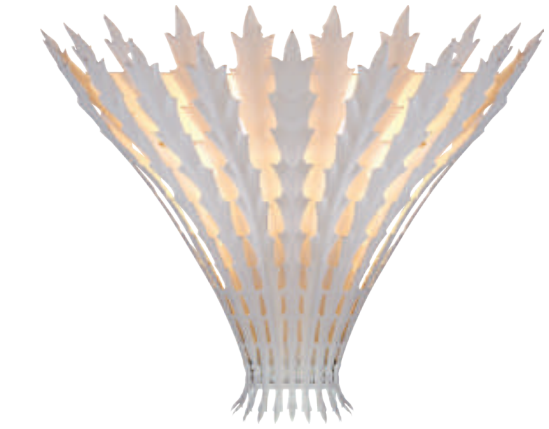

B

**JN2002PW**  
Plaster White



B

**JN2002BSL**  
Burnished Silver Leaf



B

**JN2002AGL**  
Antique Gold Leaf



opposite page

C

**HAMPTON MEDIUM SCONCE**  
AERIN

**ARN2001**  
H: 12" | W: 15" | Ext: 7"  
Backplate: 4" Round  
Socket: E26 Keyless | Bulb: 60 B

C

**ARN2001BSL**  
Burnished Silver Leaf



**A** | **CLAYMORE TAPERED ROUND SCONCE**  
E. F. CHAPMAN

**CHD1624**  
H: 20.5" | W: 16" | Ext: 4.25"  
Backplate: 4.25" Round  
Socket: E12 Candelabra | Bulb: 40 C  
©EFC DESIGNS

**A** | **CHD1624BSL**  
Burnished Silver Leaf

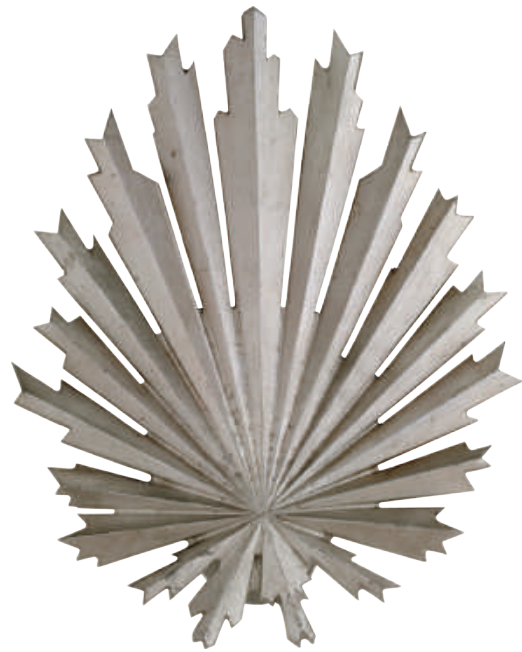

**A** | **CHD1624GI**  
Gilded Iron



**B** | **CLAYMORE SCONCE**  
E. F. CHAPMAN

**CHD1625**  
H: 25" | W: 8.25" | Ext: 4"  
Backplate: 4.25" Round  
Socket: 2 - E12 Candelabra | Bulb: 2 - 60 C  
©EFC DESIGNS

**C** | **CLAYMORE TALL SCONCE**  
E. F. CHAPMAN

**CHD1627**  
H: 38.5" | W: 10.5" | Ext: 4"  
Backplate: 4.25" Round  
Socket: 2 - E12 Candelabra | Bulb: 2 - 40 C  
©EFC DESIGNS

**B** | **CHD1625BSL**  
Burnished Silver Leaf



**B** | **CHD1625GI**  
Gilded Iron



**C** | **CHD1627BSL**  
Burnished Silver Leaf



**C** | **CHD1627GI**  
Gilded Iron





A SK4000GI  
Gilded Iron



B CS2102PW  
Plaster White



B CS2102AI  
Aged Iron



opposite page

A RÉ FLUSH MOUNT  
SUZANNE KASLER

**SK4000**  
H: 6" | W: 22" | Backplate: 5" Round  
Socket: 2 - E12 Candelabra | Bulb: 2 - 60 B  
\* Ceiling or Wall Mount

B HARLOW TAIL SCONCE  
CHRISTOPHER SPITZMILLER

**CS2102**  
H: 11.75" | W: 4.75" | Ext: 4.75"  
Backplate: 4.75" Round  
Socket: E12 Candelabra | Bulb: 40 B

C WALKER SMALL SCONCE  
KATE SPADE NEW YORK

**KS2070**  
H: 12.25" | W: 5.5" | Ext: 7.25"  
Backplate: 4.5" Round  
Socket: E12 Candelabra | Bulb: 60 B  
Shade: 5.5" x 5.5" x 6"

D GO LIGHTLY SINGLE SCONCE  
BARBARA BARRY

**BBL2080**  
H: 17" | W: 6" | Ext: 7"  
Backplate: 4.25" Round  
Socket: E12 Candelabra | Bulb: 40 C  
Shade: 5.5" x 6" x 7"

C KS2070LC-NL  
Light Cream | Natural Linen



C KS2070BSL-L  
Burnished Silver Leaf | Cream Linen



C KS2070G-L/BL  
Gild | Cream Linen | Black Linen



D BBL2080CW-S  
China White | Silk



D BBL2080G-S  
Gilded | Silk



D BBL2080C-S  
Charcoal | Silk



A	<b>ARN2201PL-L</b> Plaster   Linen	A	<b>ARN2201GP-L</b> Gilded Plaster   Linen	A	<b>ARN2201AI-L</b> Aged Iron   Linen
---	---------------------------------------	---	--	---	---



**A FONTAINE SINGLE SCONCE**  
AERIN

**ARN2201**  
H: 14.25" | W: 5.5" | Ext: 7.25"  
Backplate: 5" Round  
Socket: E12 Candelabra | Bulb: 40 B  
Shade: 3" x 5.5" x 9.5"

**B FONTAINE DOUBLE SCONCE**  
AERIN

**ARN2202**  
H: 14.25" | W: 13.25" | Ext: 7.25"  
Backplate: 5" Round  
Socket: 2 - E12 Candelabra | Bulb: 2 - 40 B  
Shade: 3" x 5.5" x 9.5"

opposite page

**C VAIL SCONCE**  
IAN K. FOWLER

**S2052**  
H: 19.75" | W: 6.25" | Ext: 3.5"  
Backplate: 4.75" Square  
Socket: E12 Candelabra | Bulb: 40 B  
Shade: 6.25" x 6.25" x 7"

C	<b>S2052GI-NP</b> Gilded Iron   Natural Paper	C	<b>S2052AI-NP</b> Aged Iron   Natural Paper	D	<b>TOB2750AI-L</b> Aged Iron   Linen
---	--	---	--	---	---



B	<b>ARN2202PL-L</b> Plaster   Linen	B	<b>ARN2202GP-L</b> Gilded Plaster   Linen	B	<b>ARN2202AI-L</b> Aged Iron   Linen
---	---------------------------------------	---	--	---	---



**D PIETRO LARGE SCONCE**  
THOMAS O'BRIEN

**TOB2750**  
H: 31.5" | W: 11" | Ext: 6.5"  
Backplate: 4" x 6.25" Rec.  
Socket: 2 - E12 Candelabra | Bulb: 2 - 60 B  
Shade: 11" x 11" x 12.25"

**E MONTREUIL SMALL WALL SCONCE**  
AERIN

**ARN2051**  
H: 22" | W: 16.5" | Ext: 11.25"  
Backplate: 4.25" Round  
Socket: 3 - E12 Candelabra | Bulb: 3 - 40 B  
Shade: 2.5" x 5" x 7"

**F KELLEY MEDIUM TRIPLE SCONCE**  
NIERMANN WEEKS

**NW2070**  
H: 14.25" | W: 19" | Ext: 12.75"  
Backplate: 5" Round  
Socket: 3 - E12 Candelabra | Bulb: 3 - 40 B  
Shade: 3" x 8" x 5"  
**Additional Options:**  
Burnished Silver Leaf | Linen (BSL-L)

E	<b>ARN2051BSL-L</b> Burnished Silver Leaf   Linen	E	<b>ARN2051G-L</b> Gild   Linen	F	<b>NW2070GI-L</b> Gilded Iron   Linen
---	--	---	-----------------------------------	---	--



A **TOB2753G-NP**  
Gild | Natural Paper



A **TOB2753BSL-NP**  
Burnished Silver Leaf | Natural Paper

B **S2030BR-NP**  
Blackened Rust | Natural Paper



C **JN2051WHT/CG-L**  
Matte White | Crystal | Linen



C **JN2051G/CG-L**  
Gild | Crystal | Linen



C **JN2051CEL/CG-L**  
Celadon | Crystal | Linen



C **JN2051MBK/CG-L**  
Matte Black | Crystal | Linen



opposite page

A **SIERRA TAIL SCONCE**  
THOMAS O'BRIEN

**TOB2753**  
H: 45" | W: 11" | Ext: 8"  
Backplate: 4" Square  
Socket: 2 - E12 Candelabra | Bulb: 2 - 40 C  
Shade: 10" x 11" x 10" Shield  
**Additional Options:**  
Plaster White | Natural Paper (PW-NP)

B **ASPEN BEDSIDE SCONCE**  
IAN K. FOWLER

**S2030**  
H: 15.5" | W: 7.5" | Ext: 9.5"  
Backplate: 5" x 12.75" Rec.  
Socket: E12 Candelabra | Bulb: 60 B  
Shade: 7.5" x 7.5" x 6"

D **TOB2116G-NP**  
Gild | Natural Paper



D **TOB2116AI-NP**  
Aged Iron | Natural Paper



C **LUCIA MEDIUM TAIL SCONCE**  
JULIE NEILL

**JN2051**  
H: 20.75" | W: 5.5" | Ext: 6"  
Backplate: 3.75" x 4.75" Rec.  
Socket: E12 Candelabra | Bulb: 40 B  
Shade: 4.5" x 5.5" x 6.25"

D **MICHEL TAIL SCONCE**  
THOMAS O'BRIEN

**TOB2116**  
H: 30.25" | W: 8.75" | Ext: 7.5"  
Backplate: 4" Round  
Socket: 2 - E12 Candelabra | Bulb: 2 - 40 B  
Shade: 8" x 8.75" x 8.25" Shield  
\* Requires Smaller Outlet Box

**A BRISTOL SINGLE SCONCE**  
AERIN

**ARN2022**  
H: 18" | W: 7" | Ext: 7.5"  
Backplate: 4.5" Round  
Socket: E12 Candelabra | Bulb: 40 B  
Shade: 5" x 7" x 6.5" Nordy



**A ARN2022BSL-L**  
Burnished Silver Leaf | Linen

**A ARN2022G-L**  
Gilded | Linen

**A ARN2022AI-L**  
Aged Iron | Linen

**C BEAUMONT MEDIUM TAIL SCONCE**  
AERIN

**ARN2301**  
H: 19" | W: 7.5" | Ext: 5.25"  
Backplate: 4.25" x 6.25" Oval  
Socket: E12 Candelabra | Bulb: 60 B  
Shade: 7" x 7.5" x 6.5"  
**Additional Options:**  
White | Linen (WHT-L)



**C ARN2301BSL-L**  
Burnished Silver Leaf | Linen

**C ARN2301G-L**  
Gild | Linen

**C ARN2301AI-L**  
Aged Iron | Linen

**B DOVER LARGE TAIL SCONCE**  
AERIN

**ARN2302**  
H: 27" | W: 7.5" | Ext: 6.5"  
Backplate: 4.25" Round  
Socket: E12 Candelabra | Bulb: 40 B  
Shade: 6" x 7.5" x 7" Oval



**B ARN2302BSL-L**  
Burnished Silver Leaf | Linen

**B ARN2302G-L**  
Gild | Linen

**B ARN2302AI-L**  
Aged Iron | Linen

**D FLIANA TAIL SCONCE**  
AERIN

**ARN2080**  
H: 24" | W: 8.5" | Ext: 5"  
Backplate: 4.5" x 5.5" Oval  
Socket: E12 Candelabra | Bulb: 40 B  
Shade: 8" x 8.5" x 6.5"



**D ARN2080PW-L**  
Plaster White | Linen

**D ARN2080G-L**  
Gild | Linen

**D ARN2080AI-L**  
Aged Iron | Linen



**A** SK2263GI-L  
Gilded Iron | Linen

**A** SK2263AI-L  
Aged Iron | Linen

**A** CAREY RAIL SCONCE  
SUZANNE KASLER  
  
SK2263  
H: 31" | W: 14.5" | Ext: 5.25"  
Backplate: 4" x 6" Rec.  
Socket: E26 Keyless | Bulb: 75 A  
Shade: 14.5" x 14.5" x 9.5" Shield

**B** TALISMAN LARGE TAIL SCONCE  
IAN K. FOWLER  
  
S2430  
H: 31.5" | W: 13.5" | Ext: 5.75"  
Backplate: 5" x 6" Rec.  
Socket: 2 - E12 Candelabra | Bulb: 2 - 40 B  
Shade: 12.25" x 13.5" x 7.5"

**C** QUATREFOIL TAIL SCONCE  
SUZANNE KASLER  
  
SK2501  
H: 32.5" | W: 14.5" | Ext: 4.75"  
Backplate: 4.5" x 6" Rec.  
Socket: E26 Keyless | Bulb: 60 A  
Shade: 14.5" x 14.5" x 9.75" Shield



**C** SK2501GI-L  
Gilded Iron | Linen

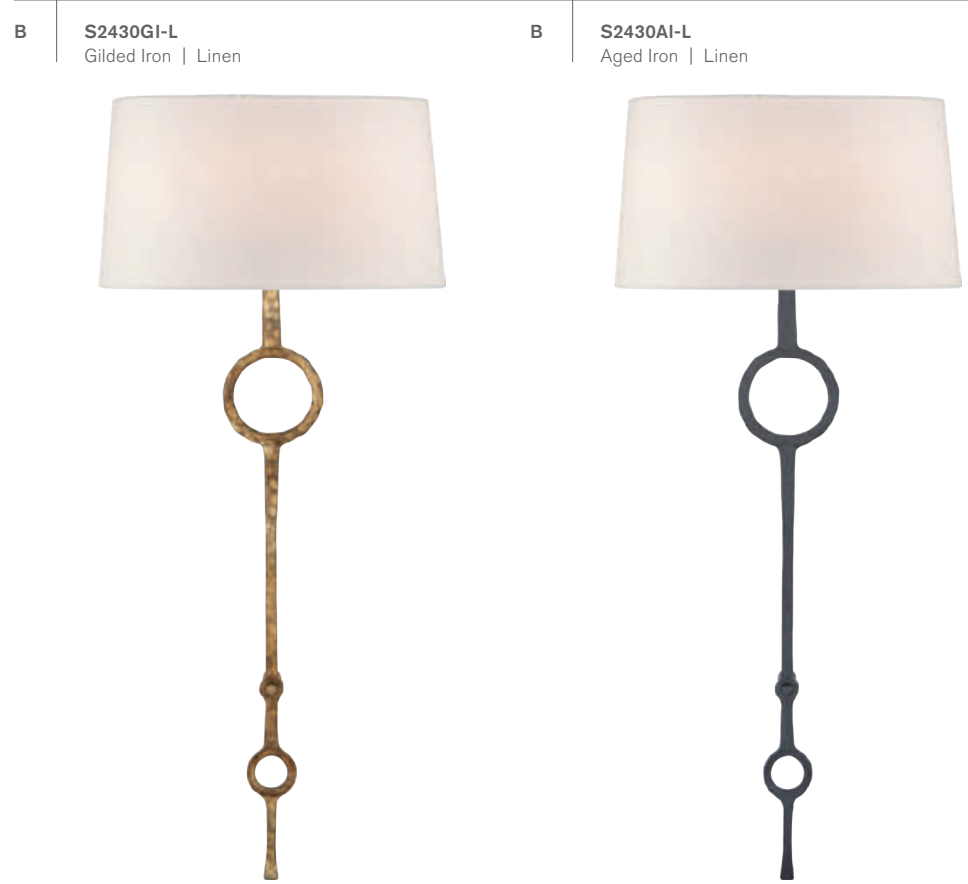

**B** S2430GI-L  
Gilded Iron | Linen

**B** S2430AI-L  
Aged Iron | Linen

**D** HEART MEDIUM SCONCE  
SUZANNE KASLER  
  
SK2258  
H: 19" | W: 12.75" | Ext: 4.25"  
Backplate: 4" Square  
Socket: E12 Candelabra | Bulb: 60 B  
Shade: 12.25" x 12.75" x 9" Rec. Shield  
**Additional Options:**  
Aged Iron | Percal (AI-L)

**E** GABRIEL DOUBLE SCONCE  
E. F. CHAPMAN  
  
CHD2315  
H: 22.5" | W: 12.5" | Ext: 7"  
Backplate: 4" x 4.375" Rec.  
Socket: 2 - E12 Candelabra | Bulb: 2 - 40 B  
Shade: 3.5" x 5" x 8"  
©EFC DESIGNS



**C** SK2501AI-L  
Aged Iron | Linen



**D** SK2258GI-PL  
Gilded Iron | Percal



**E** CHD2315PW-L  
Plaster White | Linen



**E** CHD2315AI-L  
Aged Iron | Linen

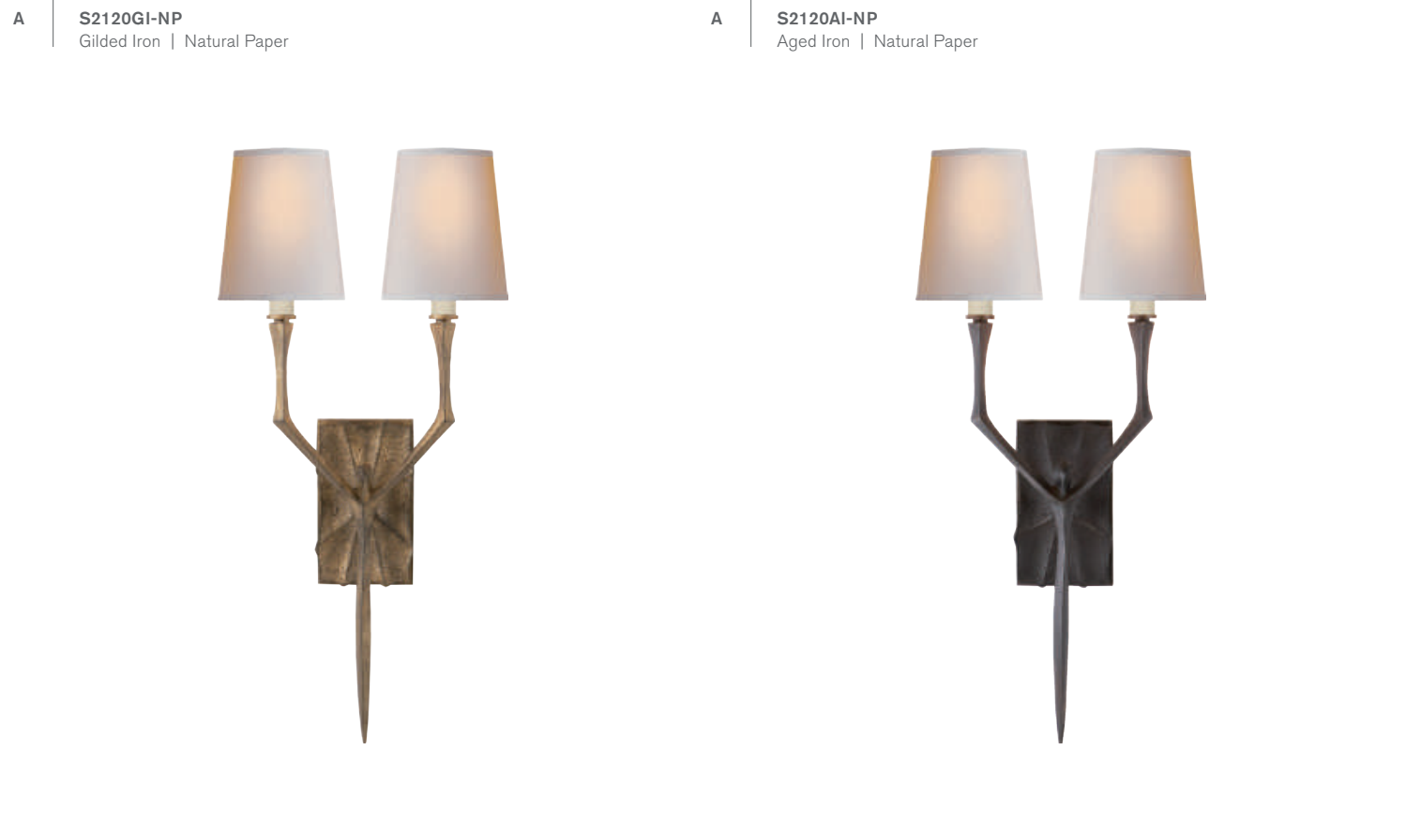

**A BRISTOL SMALL SCONCE**  
STUDIO VC

**S2120**  
H: 15.5" | W: 7.5" | Ext: 4.5"  
Backplate: 3" x 4" Rec.  
Socket: 2 - E12 Candelabra | Bulb: 2 - 40 B  
Shade: 2.5" x 3.5" x 4"  
\* French Wired

**B BRISTOL LARGE SCONCE**  
STUDIO VC

**S2121**  
H: 24.5" | W: 11.5" | Ext: 6.5"  
Backplate: 4" x 6.75" Rec.  
Socket: 2 - E12 Candelabra | Bulb: 2 - 40 B  
Shade: 10.5" x 11.5" x 6" Rec.  
\* French Wired

opposite page

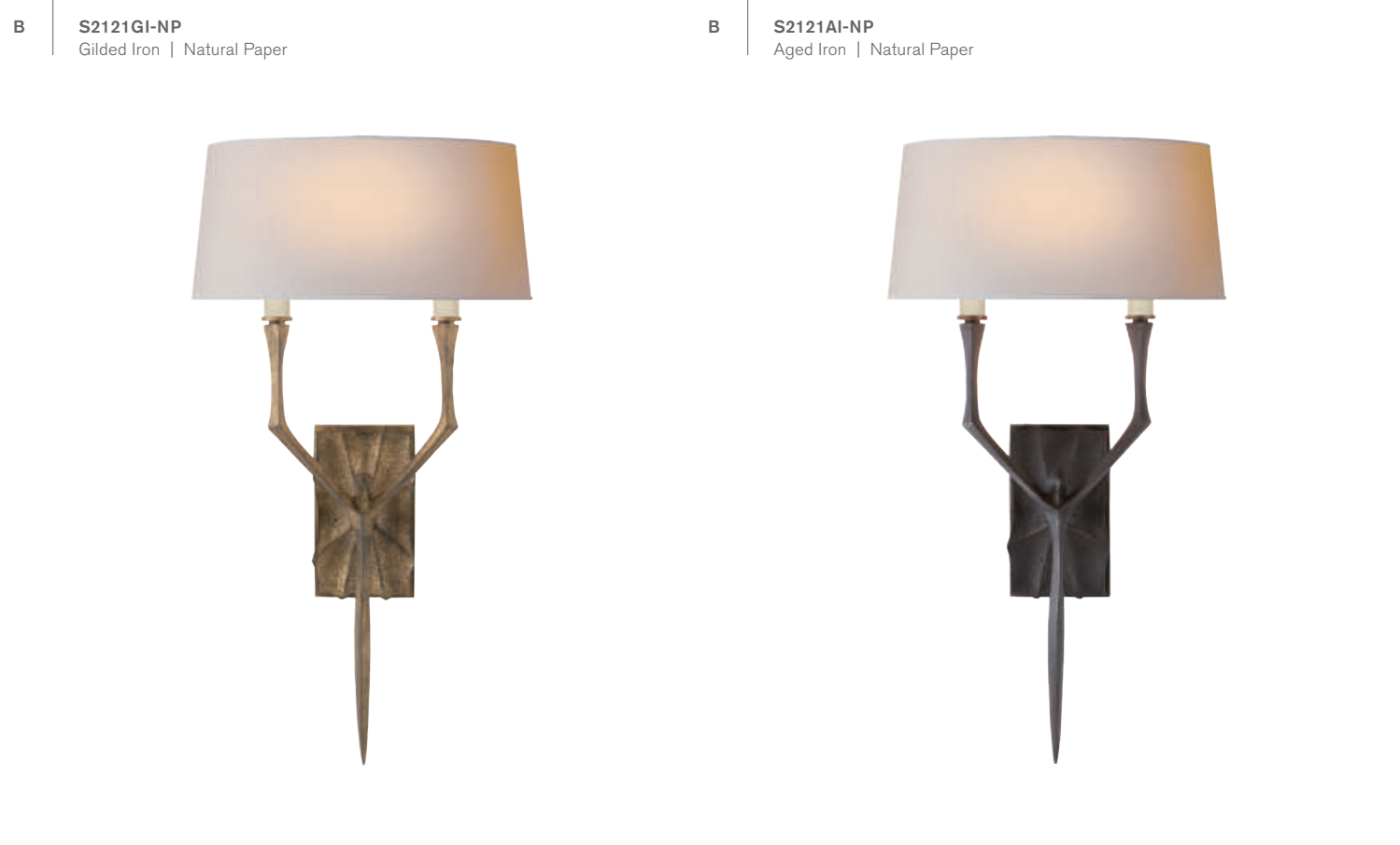

**C DAUPHINE SCONCE**  
STUDIO VC

**S2401**  
H: 19" | W: 5.5" | Ext: 4.5"  
Backplate: 4" Square  
Socket: E12 Candelabra | Bulb: 40 B  
Shade: 5" x 5.5" x 6.5" Shield  
\* Requires Smaller Outlet Box

**D STRIE TAIL SCONCE**  
E. F. CHAPMAN

**CHD2705**  
H: 25.5" | W: 11.25" | Ext: 5.25"  
Backplate: 4.25" Round  
Socket: E12 Candelabra | Bulb: 60 C  
Shade: 10.5" x 11.25" x 7" Rec. Shield  
©EFC DESIGNS

**E CRANSTON SMALL SCONCE**  
STUDIO VC

**S2406**  
H: 16.25" | W: 6.5" | Ext: 4.25"  
Backplate: 4" Round  
Socket: E12 Candelabra | Bulb: 40 B  
Shade: 6" x 6.5" x 5.25" Oval Shield

**F CRANSTON LARGE SCONCE**  
STUDIO VC

**S2408**  
H: 37" | W: 13" | Ext: 4.75"  
Backplate: 4" Round  
Socket: E26 Keyless | Bulb: 75 A  
Shade: 11" x 13" x 9.5" Oval Shield





A | **ROSWELL SCONCE**  
SUZANNE KASLER

**SK2009**  
H: 27" | W: 11" | Ext: 7.5"  
Backplate: 4.5" Round  
Socket: 2 - E26 Keyless | Bulb: 2 - 60 B  
Shade: 11" x 11" x 9" Oval Shield  
**Additional Options:**  
Belgian White | Blue Linen (BW-BL)  
Belgian White | Linen (BW-L)  
Gilded Iron | Linen (GI-L)  
Natural Rust | Linen (NR-L)  
Natural Rust | Taupe Linen (NR-TL)



B | **CAWDOR STANCHION SCONCE**  
E. F. CHAPMAN

**CHD2300**  
H: 35.75" | W: 12.5" | Ext: 7"  
Backplate: 4.25" Round  
Socket: E26 Keyless | Bulb: 75 A  
Shade: 11.75" x 12.5" x 8.25" Shield  
©EFC DESIGNS



A **CHD1404GI-NP**  
Gilded Iron | Natural Paper



A **CHD1404BR-NP**  
Blackened Rust | Natural Paper



A **IRON TORCH SCONCE**  
E. F. CHAPMAN

**CHD1404**  
H: 18" | W: 8" | Ext: 9"  
Backplate: 5.5" Round  
Socket: E26 Keyless | Bulb: 60 B  
Shade: 5" x 8" x 6"  
\* French Wired  
©EFC DESIGNS

B **LONG IRON TORCH**  
E. F. CHAPMAN

**CHD1407**  
H: 36" | W: 13.5" | Ext: 6.25"  
Backplate: 4.25" Round  
Socket: E26 Keyless | Bulb: 60 A  
Shade: 10.5" x 13.5" x 8.5" Rec. Shield  
©EFC DESIGNS

C **CHD1158GI**  
Gilded Iron



D **SK2105GI**  
Gilded Iron



D **MARGARITE SINGLE SCONCE**  
SUZANNE KASLER

**SK2105**  
H: 21" | W: 4.75" | Ext: 7"  
Backplate: 4.75" x 10.75" Rec.  
Socket: E12 Candelabra | Bulb: 60 B  
\* CHS104NP Shade Sold Separately  
\* Use 40 Bulb Frosted Type "B" with Clip On Shade

E **CHD1495GI-NP**  
Gilded Iron | Natural Paper



E **CHD1495AI-NP**  
Aged Iron | Natural Paper



B **CHD1407GI-NP**  
Gilded Iron | Natural Paper



B **CHD1407BR-NP**  
Blackened Rust | Natural Paper



C **CHD1158R**  
Hand Painted Rust Finish



D **SK2105AI**  
Aged Iron



E **FLEMISH SINGLE SCONCE**  
E. F. CHAPMAN

**CHD1495**  
H: 15.25" | W: 6.5" | Ext: 11.75"  
Backplate: 4" x 6.5" Rec.  
Socket: E12 Candelabra | Bulb: 60 B  
Shade: 4.5" x 6" x 5.5"  
©EFC DESIGNS

F **FLEMISH DOUBLE SCONCE**  
E. F. CHAPMAN

**CHD1496**  
H: 15" | W: 12.5" | Ext: 11.75"  
Backplate: 4" x 6.5" Rec.  
Socket: 2 - E12 Candelabra | Bulb: 2 - 60 B  
Shade: 4.5" x 6" x 5.5"  
©EFC DESIGNS

F **CHD1496GI-NP**  
Gilded Iron | Natural Paper



F **CHD1496AI-NP**  
Aged Iron | Natural Paper



C **PERCHING BIRD SCONCE**  
E. F. CHAPMAN

**CHD1158**  
H: 14" | W: 5" | Ext: 7"  
Backplate: 6.75" x 4.75" Oval  
Socket: E12 Candelabra | Bulb: 60 C  
\* CHS104B Shade Sold Separately  
\* Use 40 Bulb Frosted Type "B" with Clip On Shade  
©EFC DESIGNS



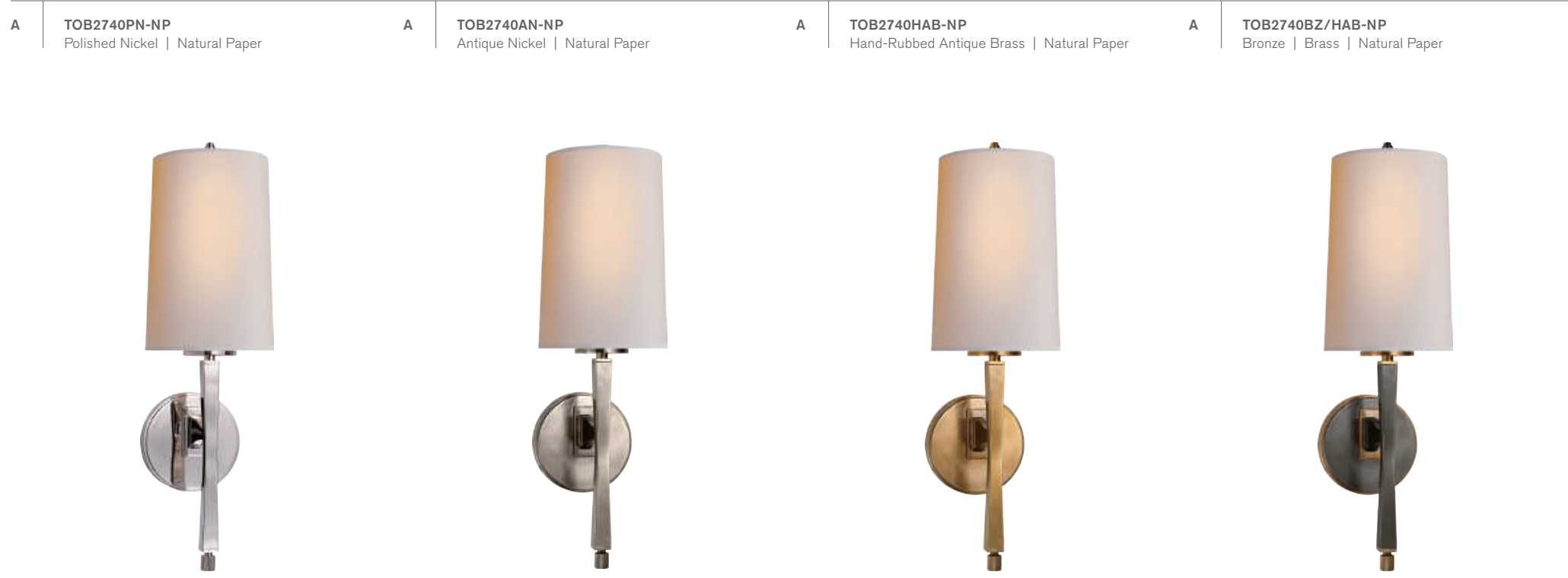

**A** **EDIE SCONCE**  
THOMAS O'BRIEN

**TOB2740**  
H: 18.5" | W: 5.5" | Ext: 6.75"  
Backplate: 4.5" Round  
Socket: E26 Keyless | Bulb: 60 A  
Shade: 5" x 5.5" x 8"  
**Additional Options:**  
Bronze | Natural Paper (BZ-NP)

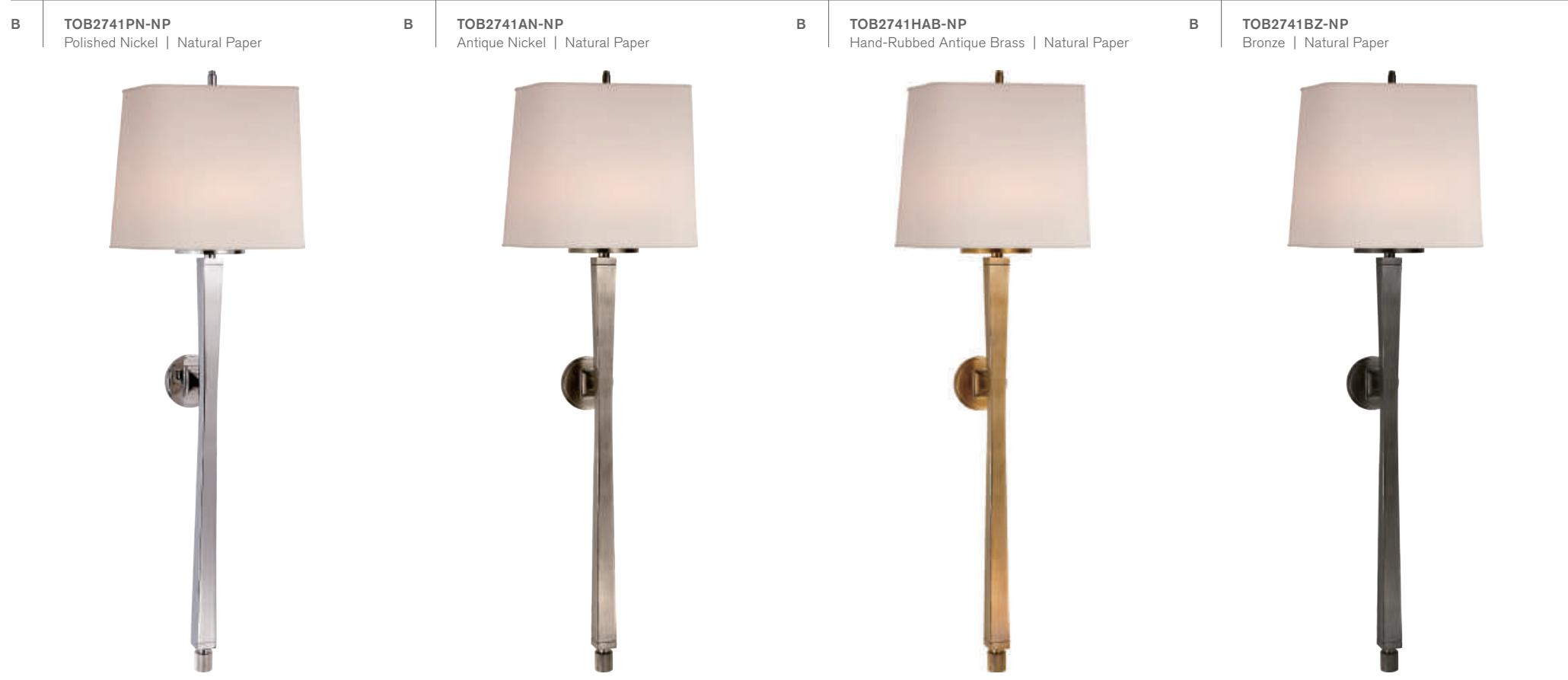

**B** **EDIE BALUSTER SCONCE**  
THOMAS O'BRIEN

**TOB2741**  
H: 32.75" | W: 10" | Ext: 7"  
Backplate: 4" Square  
Socket: 2 - E12 Candelabra | Bulb: 2 - 40 C  
Shade: 9" x 10" x 8" Shield  
\* Requires Smaller Outlet Box



**B** **TOB2741BZ/HAB-NP**  
Bronze | Brass | Natural Paper

A **TOB2002AN-NP**  
Antique Nickel | Natural Paper



A **TOB2002HAB-NP**  
Hand-Rubbed Antique Brass | Natural Paper



A **TOB2002PN-NP/ST**  
Polished Nickel | Natural Paper | Silver Tape



A **BRYANT SCONCE**  
THOMAS O'BRIEN  
  
**TOB2002**  
H: 14.25" | W: 5.5" | Ext: 8.75"  
Backplate: 4" Round  
Socket: E26 Keyless | Bulb: 60 A  
Shade: 4" x 5.5" x 6"  
**Additional Options:**  
Bronze | Natural Paper | Black Tape (BZ-NP/BT)  
\* Requires Smaller Outlet Box

B **BRYANT LARGE TAIL SCONCE**  
THOMAS O'BRIEN  
  
**TOB2024**  
H: 29.5" | W: 6.5" | Ext: 8.5"  
Backplate: 4.5" Round  
Socket: E26 Keyless | Bulb: 60 A  
Shade: 4.5" x 6.5" x 6.75"  
**Additional Options:**  
Antique Nickel | Natural Paper (AN-NP)

C **BRYANT LARGE DOUBLE TAIL SCONCE**  
THOMAS O'BRIEN  
  
**TOB2025**  
H: 26" | W: 16" | Ext: 9"  
Backplate: 4" Round  
Socket: 2 - E26 Keyless | Bulb: 2 - 40 A  
Shade: 4.5" x 6.5" x 6.75"

C **TOB2025PN-NP**  
Polished Nickel | Natural Paper



B **TOB2024PN-NP**  
Polished Nickel | Natural Paper



B **TOB2024HAB-NP**  
Hand-Rubbed Antique Brass | Natural Paper



B **TOB2024BZ-NP**  
Bronze | Natural Paper



C **TOB2025AN-NP**  
Antique Nickel | Natural Paper



C **TOB2025HAB-NP**  
Hand-Rubbed Antique Brass | Natural Paper



C **TOB2025BZ-NP**  
Bronze | Natural Paper



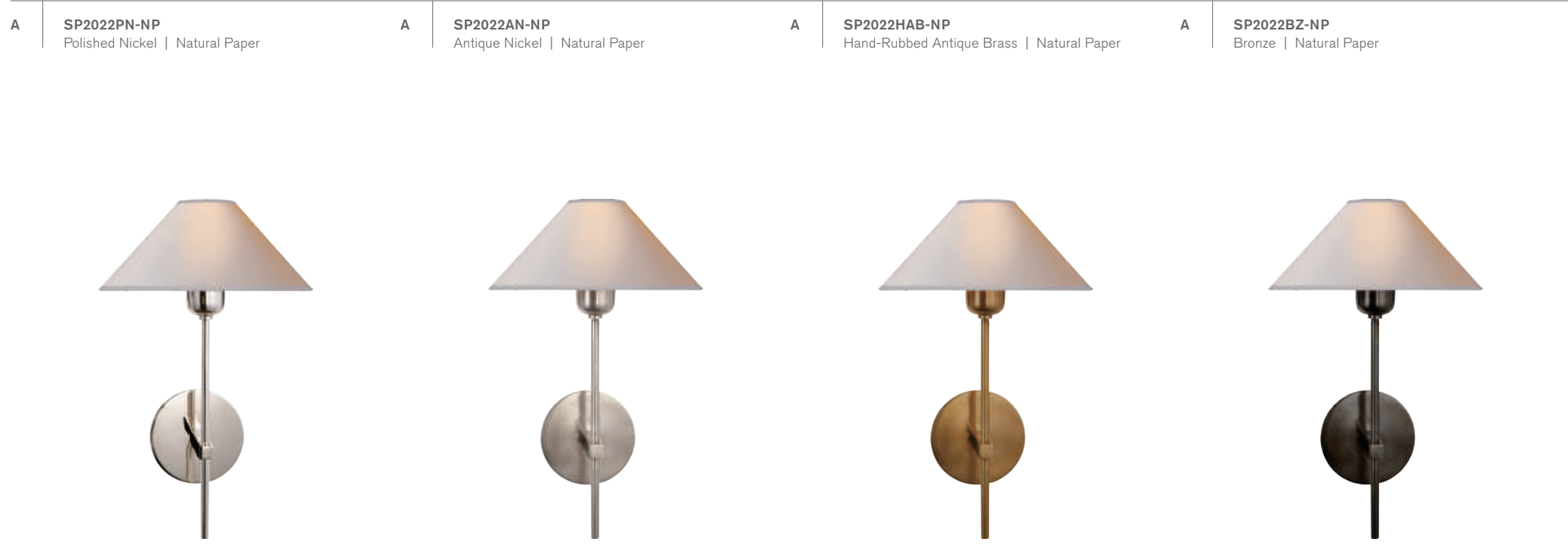

**A** **HACKNEY SINGLE SCONCE**  
J. RANDALL POWERS

**SP2022**  
H: 14" | W: 9" | Ext: 9.25"  
Backplate: 4" Round  
Socket: E12 Candelabra | Bulb: 40 B  
Shade: 2.5" x 9" x 5" Round  
\* Requires Smaller Outlet Box

**B** **SK2251AB-L**  
Antique-Burnished Brass | Linen



**B** **LANA TAIL SCONCE**  
SUZANNE KASLER

**SK2251**  
H: 29.75" | W: 12" | Ext: 5"  
Backplate: 4" Square  
Socket: 2 - E12 Candelabra | Bulb: 2 - 60 B  
Shade: 10.75" x 12" x 7" Rec. Shield  
\* Requires Smaller Outlet Box



**A SYMMETRIC TWIST SINGLE SCONCE**  
E. F. CHAPMAN

**CHD1610**  
H: 16" | W: 5" | Ext: 5.25"  
Backplate: 4.5" Round  
Socket: E12 Candelabra | Bulb: 60 B  
Shade: 3.5" x 5" x 4.5"  
©EFC DESIGNS

**B SYMMETRIC TWIST DOUBLE SCONCE**  
E. F. CHAPMAN

**CHD1612**  
H: 20" | W: 13.5" | Ext: 6.75"  
Backplate: 4.5" Round  
Socket: 2 - E12 Candelabra | Bulb: 2 - 60 B  
Shade: 13" x 13.5" x 5.25"  
©EFC DESIGNS

**B CHD1612AN-NP**  
Antique Nickel | Natural Paper



**A CHD1610PN-NP**  
Polished Nickel | Natural Paper



**A CHD1610AN-NP**  
Antique Nickel | Natural Paper



**A CHD1610AB-NP**  
Antique-Burnished Brass | Natural Paper



**A CHD1610BZ-NP**  
Bronze | Natural Paper



**B CHD1612PN-NP**  
Polished Nickel | Natural Paper



**B CHD1612AB-NP**  
Antique-Burnished Brass | Natural Paper



**B CHD1612BZ-NP**  
Bronze | Natural Paper



**B** | **CHD1191PN-NP**  
Polished Nickel | Natural Paper



**A** | **CROSS BOUILLLOTTE SMALL SCONCE**  
E. F. CHAPMAN

**CHD1190**  
H: 12.5" | W: 10" | Ext: 4.5"  
Backplate: 2.25" x 4.5" Rec.  
Socket: 2 - E12 Candelabra | Bulb: 2 - 40 B  
Shade: 9" x 10" x 5" Rec. Shield  
\* French Wired  
\* Requires Smaller Outlet Box  
©EFC DESIGNS

**B** | **CROSS BOUILLLOTTE LARGE SCONCE**  
E. F. CHAPMAN

**CHD1191**  
H: 14.75" | W: 15" | Ext: 6"  
Backplate: 4.25" Round  
Socket: 2 - E12 Candelabra | Bulb: 2 - 40 B  
Shade: 14" x 15" x 5.25" Rec. Shield  
\* French Wired  
©EFC DESIGNS

**A** | **CHD1190PN-NP**  
Polished Nickel | Natural Paper



**A** | **CHD1190AN-NP**  
Antique Nickel | Natural Paper



**A** | **CHD1190AB-NP**  
Antique-Burnished Brass | Natural Paper



**A** | **CHD1190BZ-NP**  
Bronze | Natural Paper



**B** | **CHD1191PN-NP**  
Polished Nickel | Natural Paper



**B** | **CHD1191AN-NP**  
Antique Nickel | Natural Paper



**B** | **CHD1191AB-NP**  
Antique-Burnished Brass | Natural Paper



**B** | **CHD1191BZ-NP**  
Bronze | Natural Paper



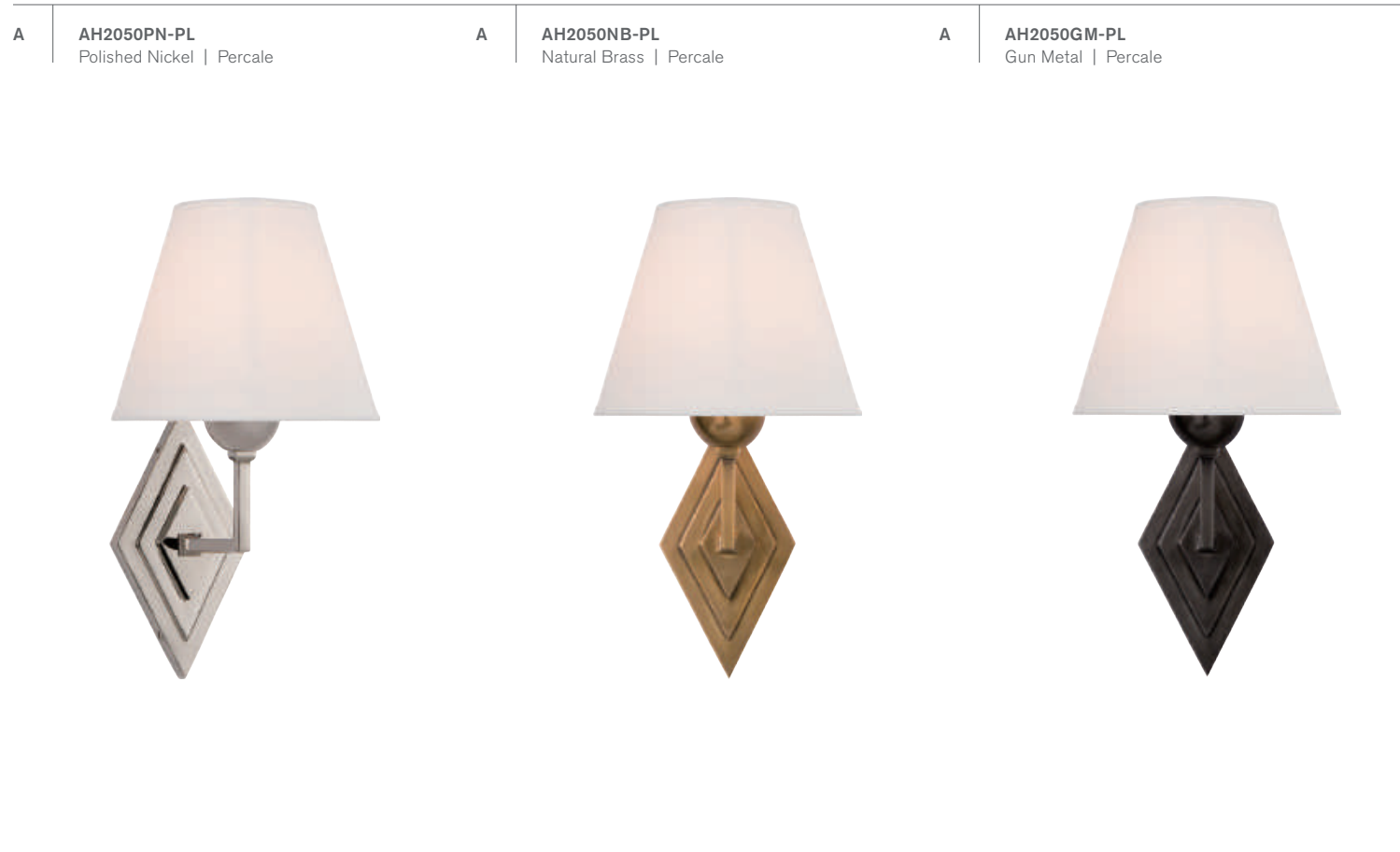

**A** AH2050PN-PL  
Polished Nickel | Percale

**A** AH2050NB-PL  
Natural Brass | Percale

**A** AH2050GM-PL  
Gun Metal | Percale

**A** **BETTINA SINGLE SCONCE**  
ALEXA HAMPTON

**AH2050**  
H: 12.75" | W: 8.25" | Ext: 9.5"  
Backplate: 3.75" x 7.5" Diamond  
Socket: E26 Keyless | Bulb: 60 A  
Shade: 4" x 8.25" x 6.5"  
\* Requires Smaller Outlet Box

**B** **SILHOUETTE FRETWORK SCONCE**  
THOMAS O'BRIEN

**TOB2600**  
H: 16.5" | W: 8.75" | Ext: 4.5"  
Backplate: 4" x 8"  
Socket: 2 - E12 Candelabra | Bulb: 2 - 25 B  
Shade: 8.5" x 8.75" x 6.5"

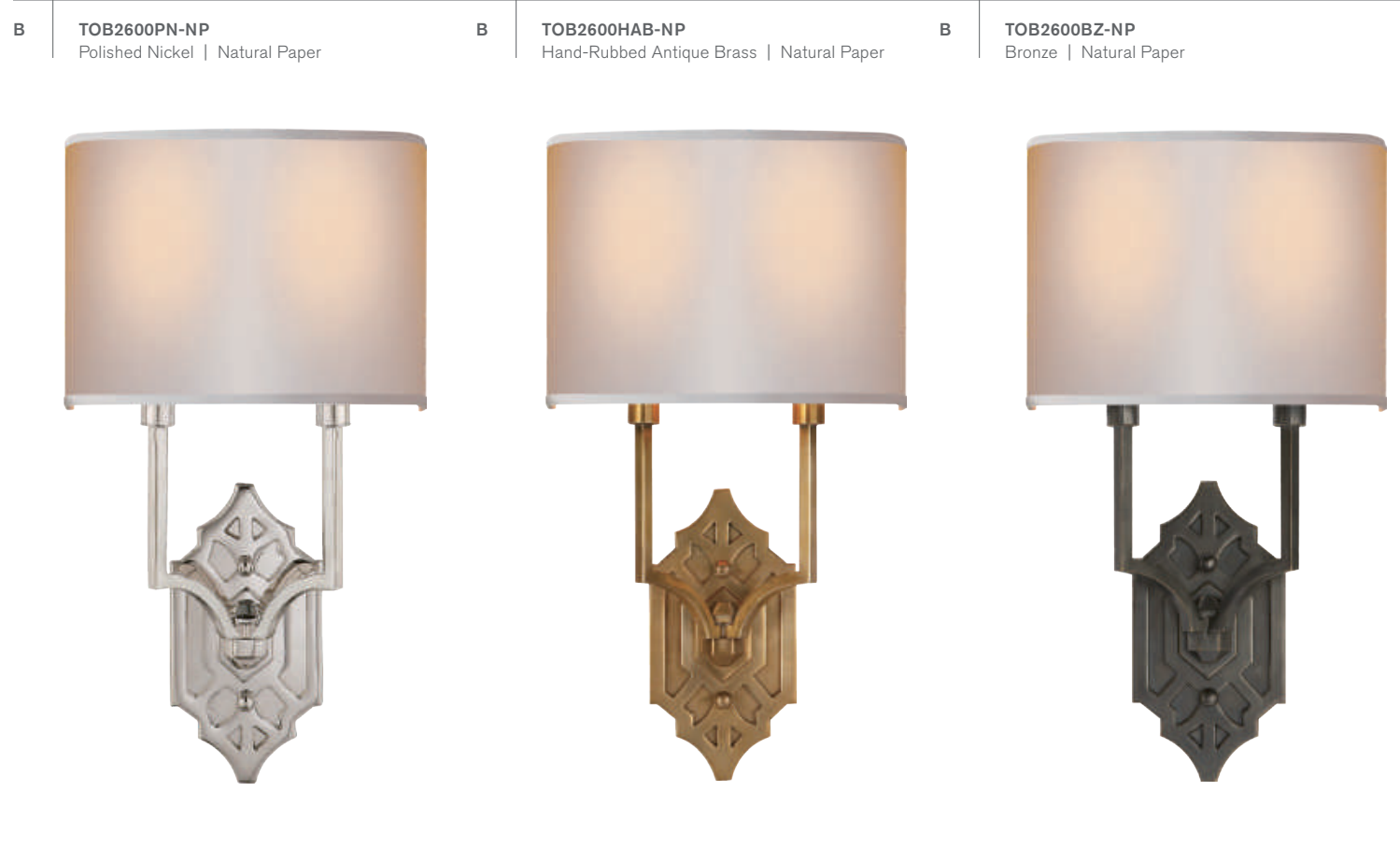

**B** TOB2600PN-NP  
Polished Nickel | Natural Paper

**B** TOB2600HAB-NP  
Hand-Rubbed Antique Brass | Natural Paper

**B** TOB2600BZ-NP  
Bronze | Natural Paper

opposite page

**C** **SAVANNAH SCONCE**  
JOHN ROSSELLI

**SR2140**  
H: 16" | W: 5" | Ext: 5.75"  
Backplate: 5" x 16" Rec.  
Socket: E12 Candelabra | Bulb: 60 B



**B** TOB2600HAB-NP  
Hand-Rubbed Antique Brass | Natural Paper



**C** SR2140SHS  
Sheffield Silver



**C** SR2140HAB  
Hand-Rubbed Antique Brass



A

**CHD2460PN-NP**  
Polished Nickel | Natural Paper

**A RUHLMANN SINGLE SCONCE**  
E. F. CHAPMAN

**CHD2460**  
H: 22.5" | W: 6.25" | Ext: 7"  
Backplate: 3.5" x 6.25"  
Socket: E12 Candelabra | Bulb: 40 B  
Shade: 5.5" x 6.25" x 6" Shield  
\* Requires Smaller Outlet Box  
©EFC DESIGNS

A

**CHD2460PN-NP**  
Polished Nickel | Natural Paper

A

**CHD2460AN-NP**  
Antique Nickel | Natural Paper

A

**CHD2460AB-NP**  
Antique-Burnished Brass | Natural Paper

A

**CHD2460BZ-NP**  
Bronze | Natural Paper



**B RUHLMANN DOUBLE SCONCE**  
E. F. CHAPMAN

**CHD2461**  
H: 22.5" | W: 10.75" | Ext: 6.25"  
Backplate: 3.5" x 6.25"  
Socket: 2 - E12 Candelabra | Bulb: 2 - 40 B  
Shade: 10.5" x 10.75" x 6" Rec. Shield  
\* Requires Smaller Outlet Box  
©EFC DESIGNS

B

**CHD2461PN-NP**  
Polished Nickel | Natural Paper

B

**CHD2461AN-NP**  
Antique Nickel | Natural Paper

B

**CHD2461AB-NP**  
Antique-Burnished Brass | Natural Paper

B

**CHD2461BZ-NP**  
Bronze | Natural Paper



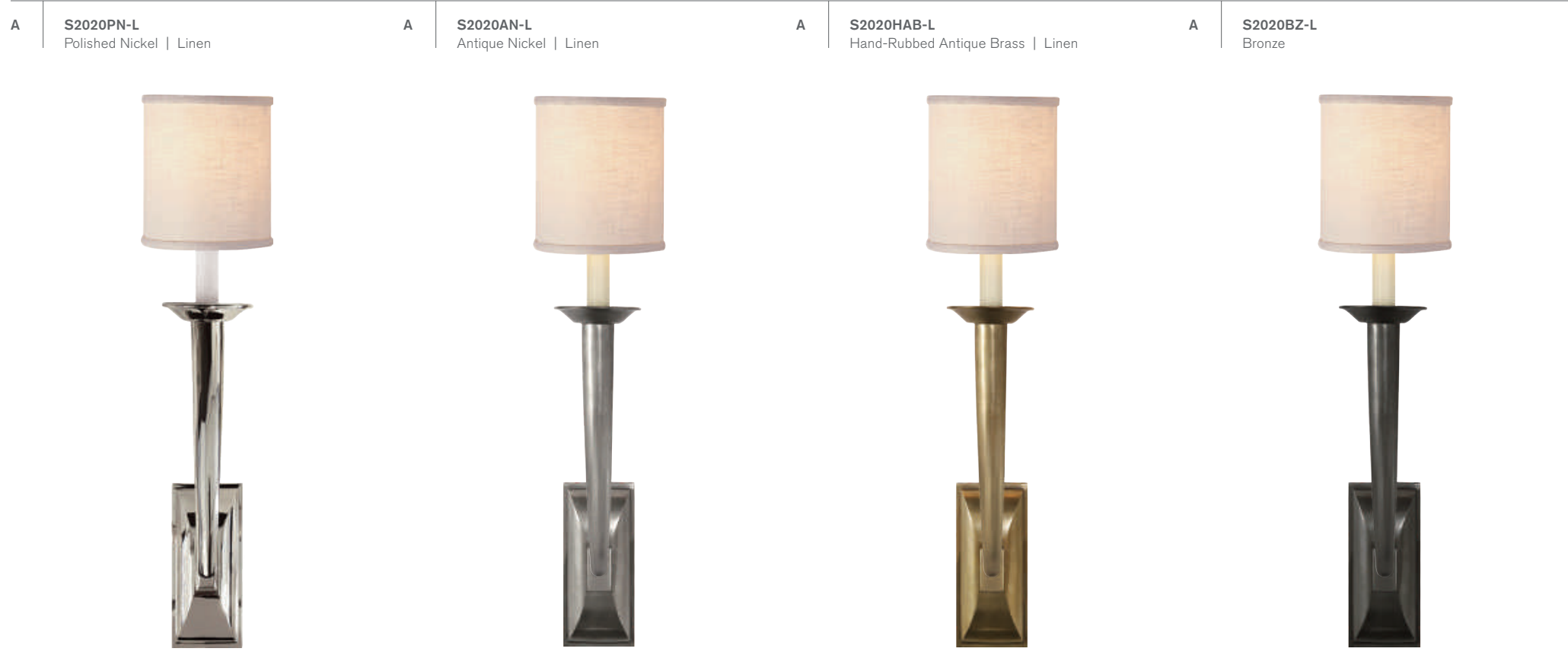

**A** | **FRENCH DECO HORN SCONCE**  
IAN K. FOWLER

**S2020**  
H: 23.5" | W: 5" | Ext: 7"  
Backplate: 3.25" x 7" Rec.  
Socket: E12 Candelabra | Bulb: 40 B  
Shade: 5" x 5" x 6"  
\* Requires Smaller Outlet Box

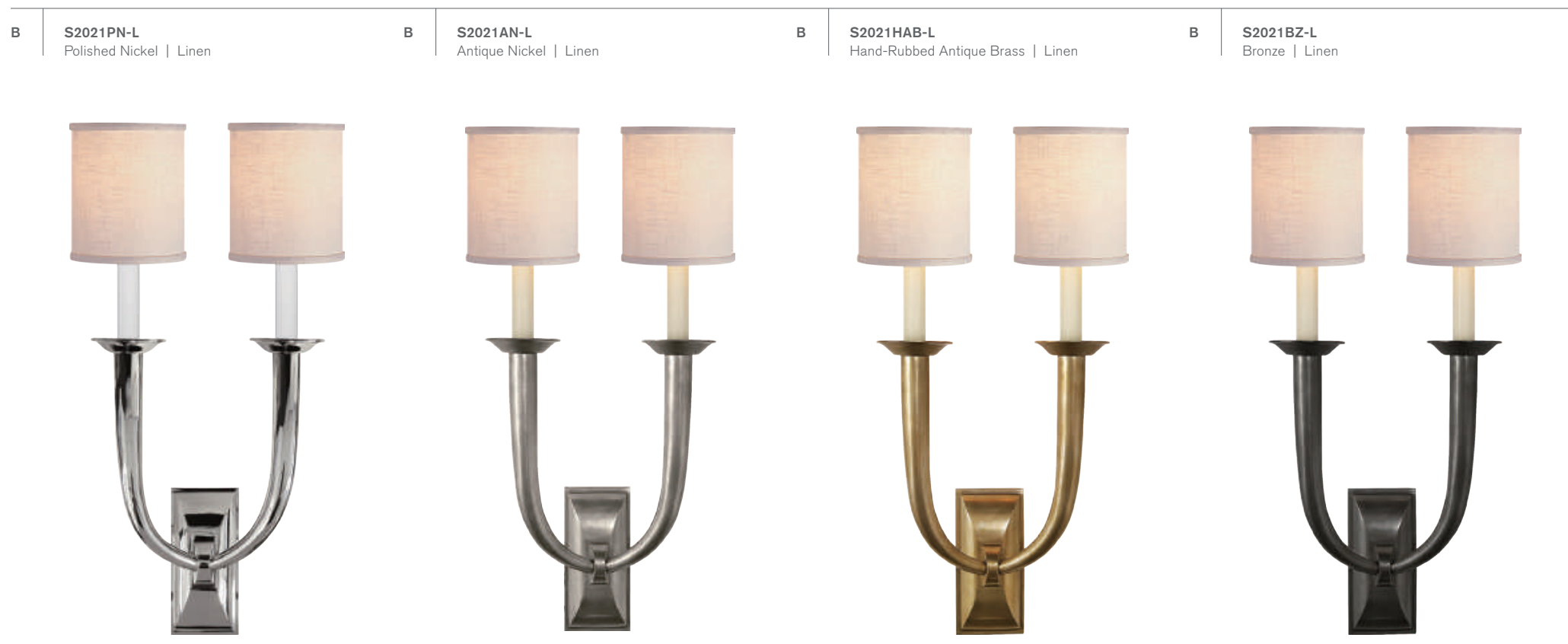

**B** | **FRENCH DECO HORN DOUBLE SCONCE**  
IAN K. FOWLER

**S2021**  
H: 22" | W: 12.25" | Ext: 6"  
Backplate: 3.25" x 7" Rec.  
Socket: 2 - E12 Candelabra | Bulb: 2 - 40 B  
Shade: 3" x 5" x 4"  
\* Requires Smaller Outlet Box



**A** | **S2020BZ-L**  
Bronze | Linen





**A TT SINGLE SCONCE**  
E. F. CHAPMAN

**SL2860**  
H: 18" | W: 4" | Ext: 7"  
Backplate: 4" x 6" Rec.  
Socket: E12 Candelabra | Bulb: 60 C  
\* CHS104NP Shade Sold Separately  
\* Use 40 Bulb Frosted Type "B" with Clip On Shade  
©EFC DESIGNS

**B TT DOUBLE SCONCE**  
E. F. CHAPMAN

**SL2861**  
H: 18" | W: 10" | Ext: 7"  
Backplate: 4" x 6" Rec.  
Socket: 2 - E12 Candelabra | Bulb: 2 - 60 C  
\* CHS104NP Shade Sold Separately  
\* Use 40 Bulb Frosted Type "B" with Clip On Shade  
©EFC DESIGNS

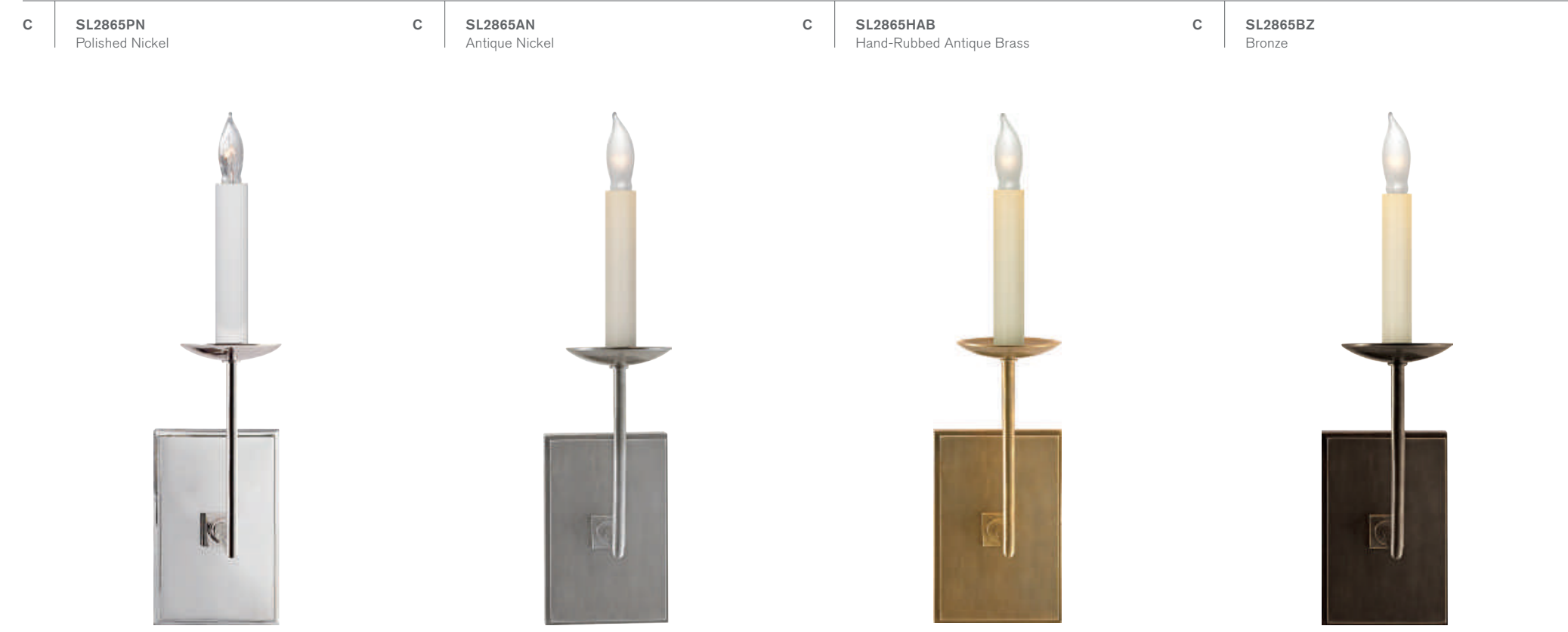

**C SL2865PN**  
Polished Nickel

**C SL2865AN**  
Antique Nickel

**C SL2865HAB**  
Hand-Rubbed Antique Brass

**C SL2865BZ**  
Bronze

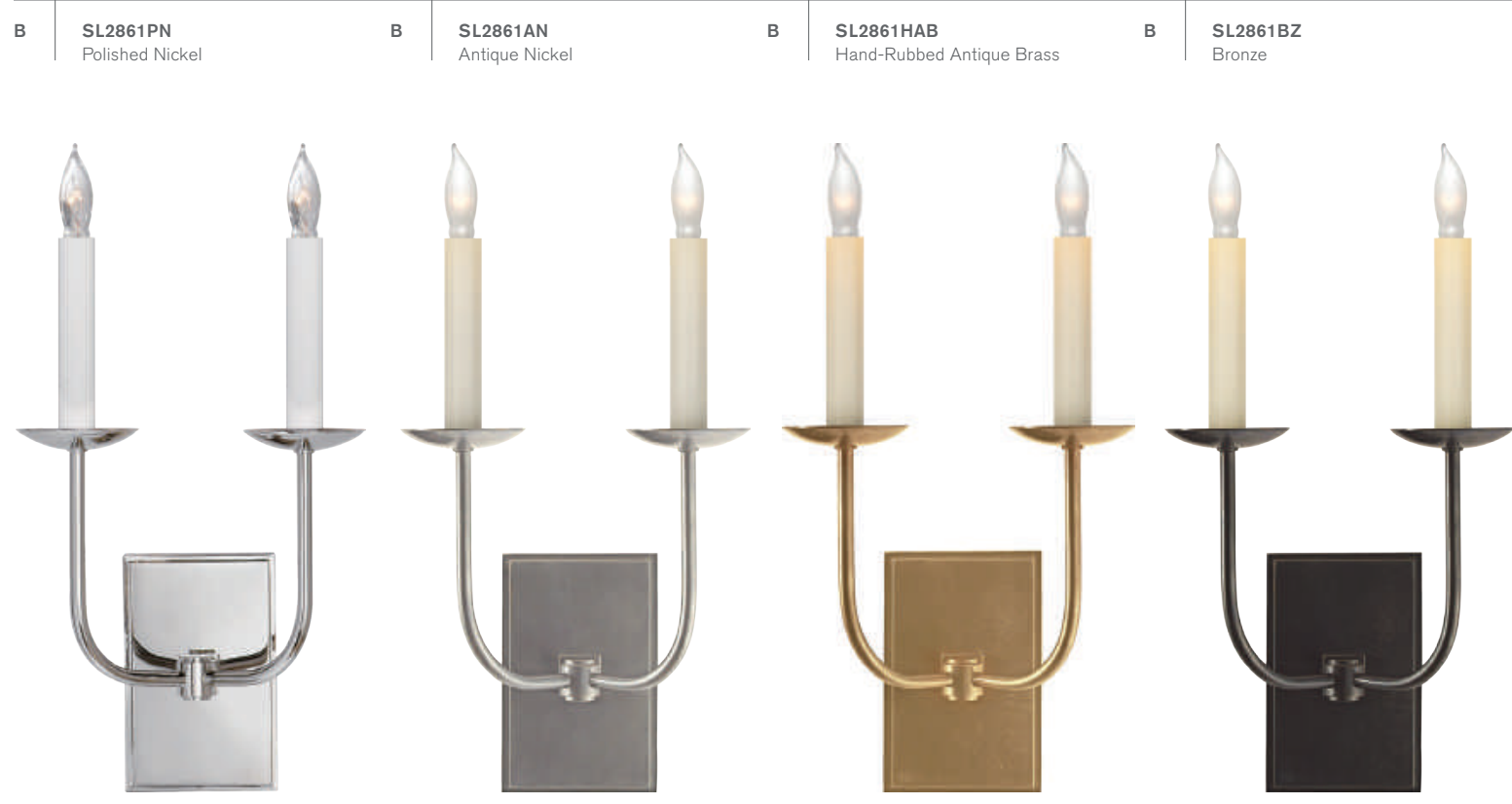

opposite page

**C RIGHT ANGLE SINGLE SCONCE**  
E. F. CHAPMAN

**SL2865**  
H: 18" | W: 4" | Ext: 7"  
Backplate: 4" x 6" Rec.  
Socket: E12 Candelabra | Bulb: 60 C  
\* CHS104NP Shade Sold Separately  
\* Use 40 Bulb Frosted Type "B" with Clip On Shade  
©EFC DESIGNS

**D RIGHT ANGLE DOUBLE SCONCE**  
E. F. CHAPMAN

**SL2866**  
H: 18" | W: 10" | Ext: 7"  
Backplate: 4" x 6" Rec.  
Socket: 2 - E12 Candelabra | Bulb: 2 - 60 C  
\* SH11.5X12X5.75NP Rec. Shade Sold Separately  
©EFC DESIGNS

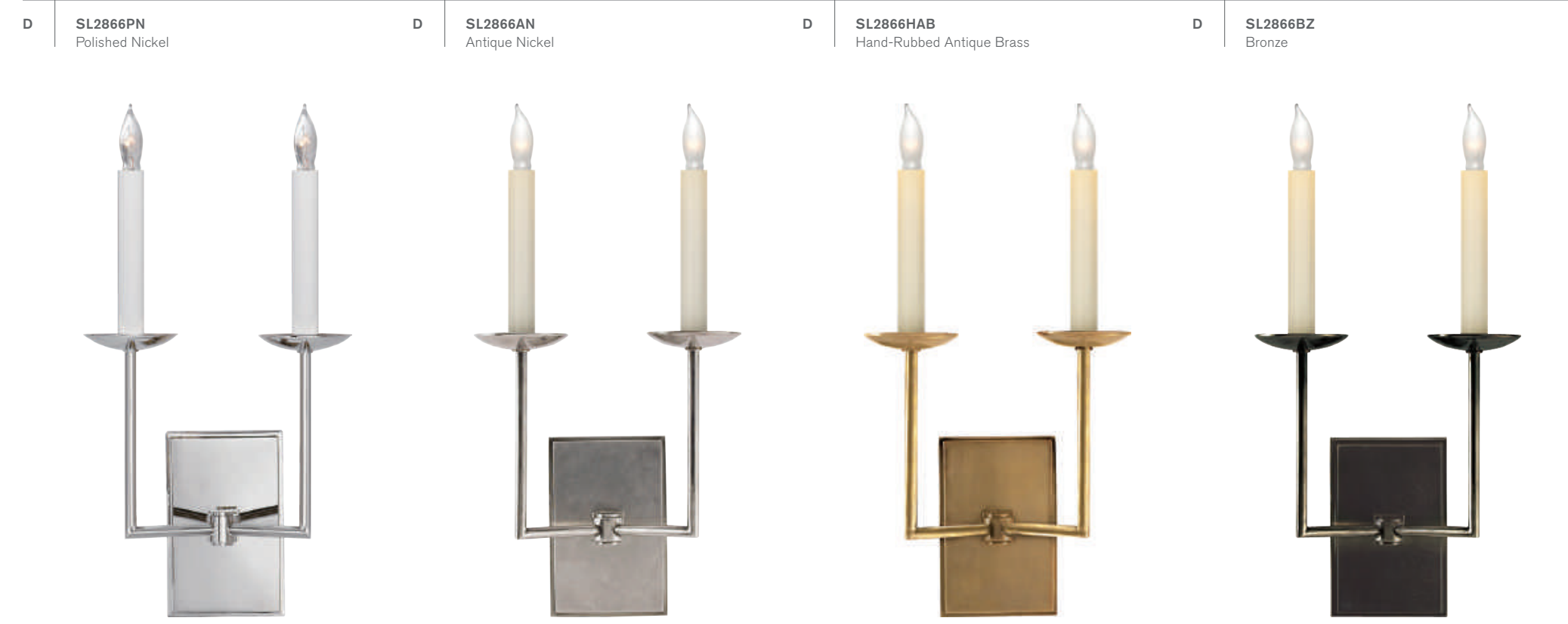

**D SL2866PN**  
Polished Nickel

**D SL2866AN**  
Antique Nickel

**D SL2866HAB**  
Hand-Rubbed Antique Brass

**D SL2866BZ**  
Bronze

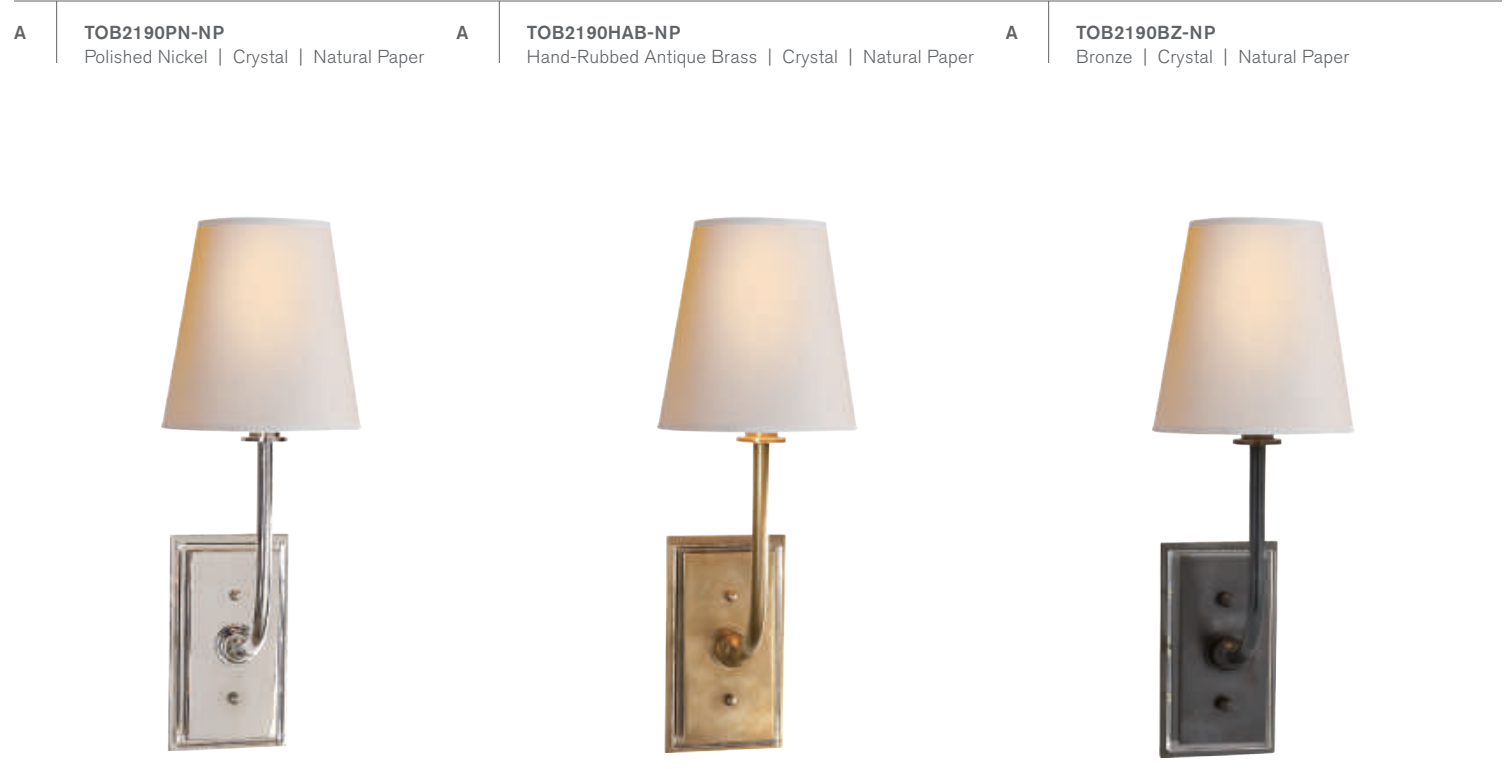

**A** **HULTON SINGLE SCONCE**  
THOMAS O'BRIEN

**TOB2190**  
H: 16.5" | W: 6" | Ext: 7.5"  
Backplate: 4" x 7.25" Rec.  
Socket: E12 Candelabra | Bulb: 60 B  
Shade: 4" x 6" x 6.5" Oval

**C** **VENINI SINGLE SCONCE**  
E. F. CHAPMAN

**CHD2620**  
H: 15.25" | W: 4.75" | Ext: 6"  
Backplate: 4.5" Square  
Socket: E12 Candelabra | Bulb: 25 B  
Shade: 3.5" x 4.75" x 6.25"  
©EFC DESIGNS

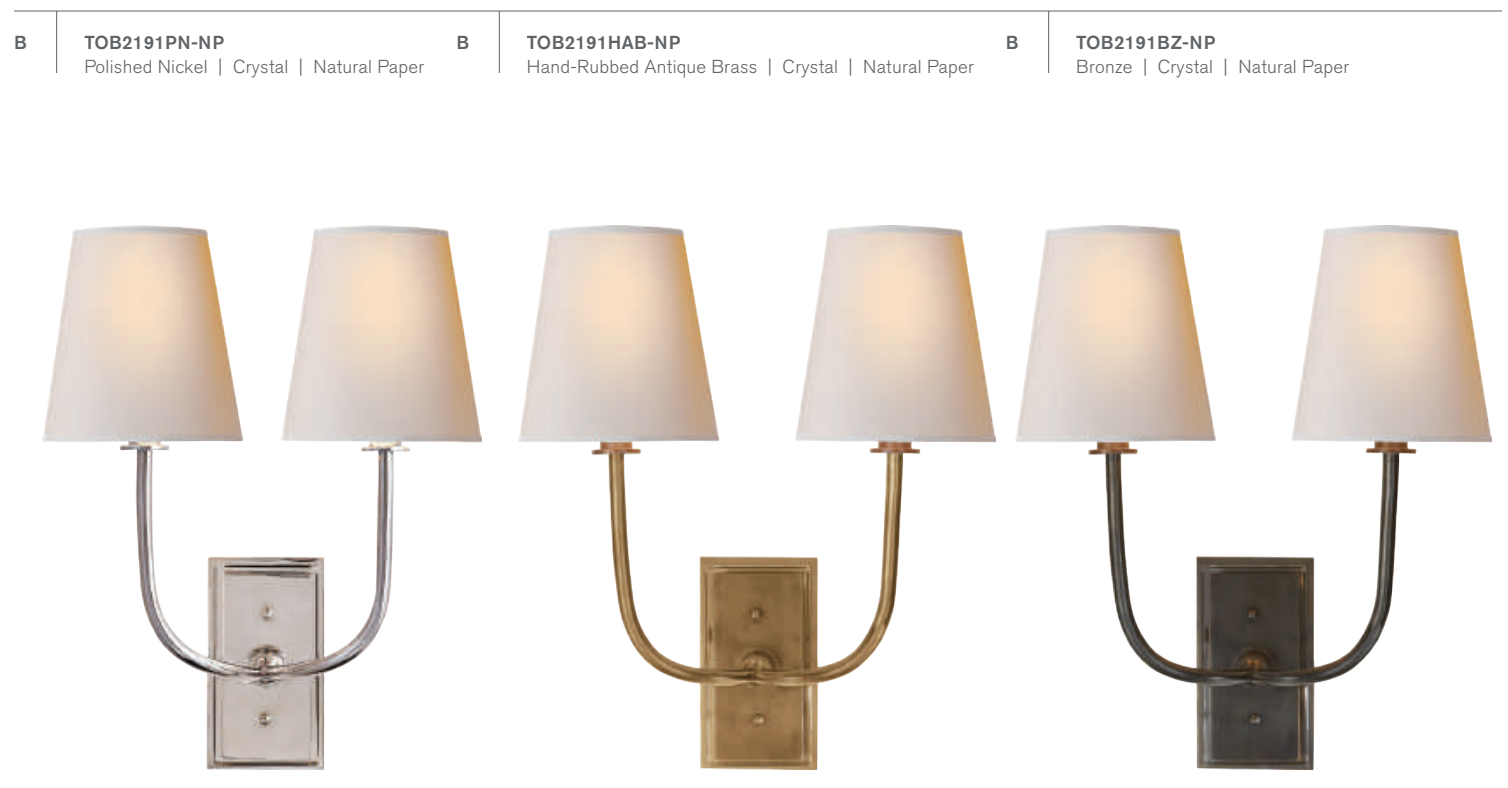
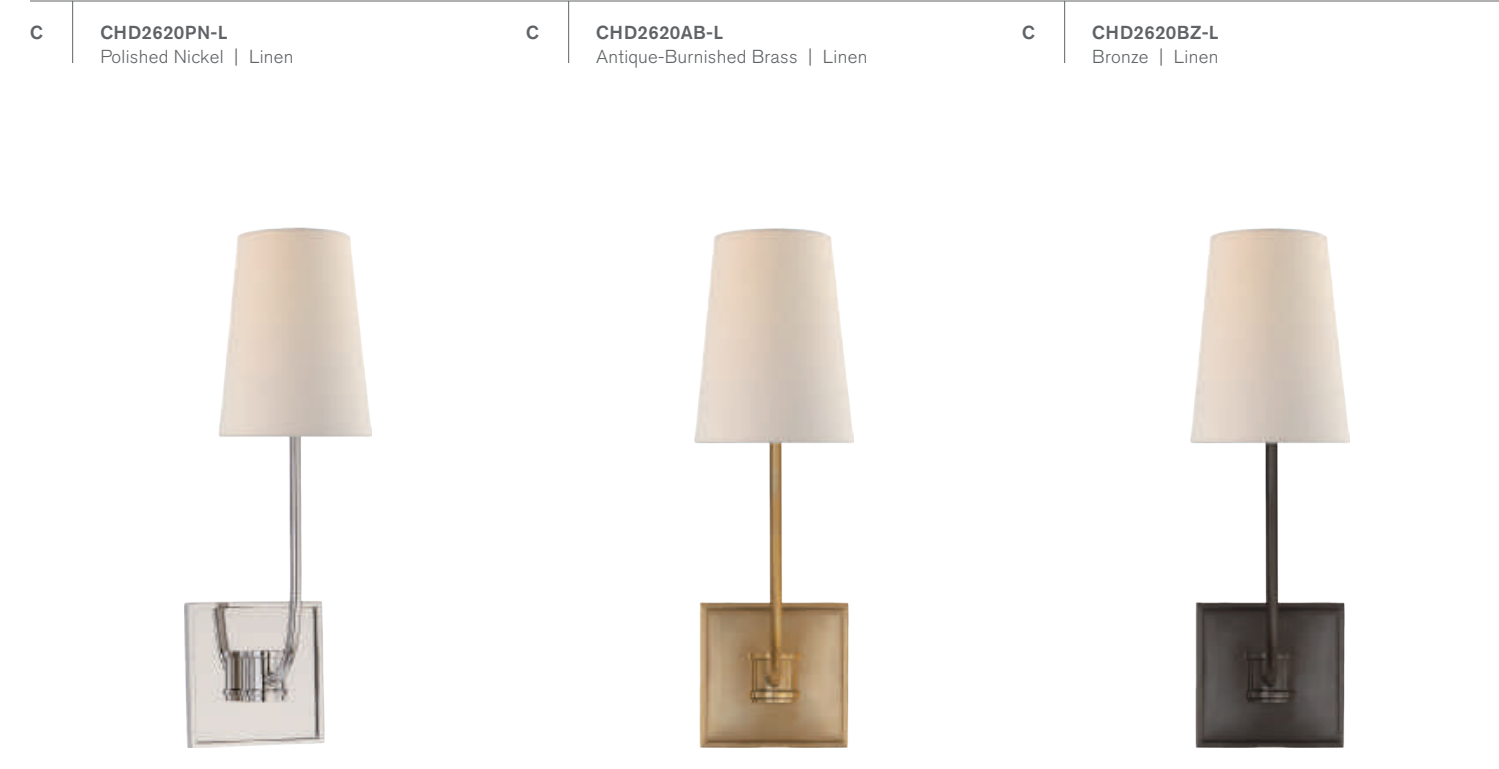

**B** **HULTON DOUBLE SCONCE**  
THOMAS O'BRIEN

**TOB2191**  
H: 16.5" | W: 14" | Ext: 9.5"  
Backplate: 4" x 7.25" Rec.  
Socket: 2 - E12 Candelabra | Bulb: 2 - 60 B  
Shade: 4" x 6" x 6.5" Oval

**D** **VENINI DOUBLE SCONCE**  
E. F. CHAPMAN

**CHD2621**  
H: 18" | W: 13.5" | Ext: 5.5"  
Backplate: 5.5" x 6" Rec.  
Socket: 2 - E12 Candelabra | Bulb: 2 - 40 B  
Shade: 12" x 13.5" x 7" Rec. Shield  
©EFC DESIGNS

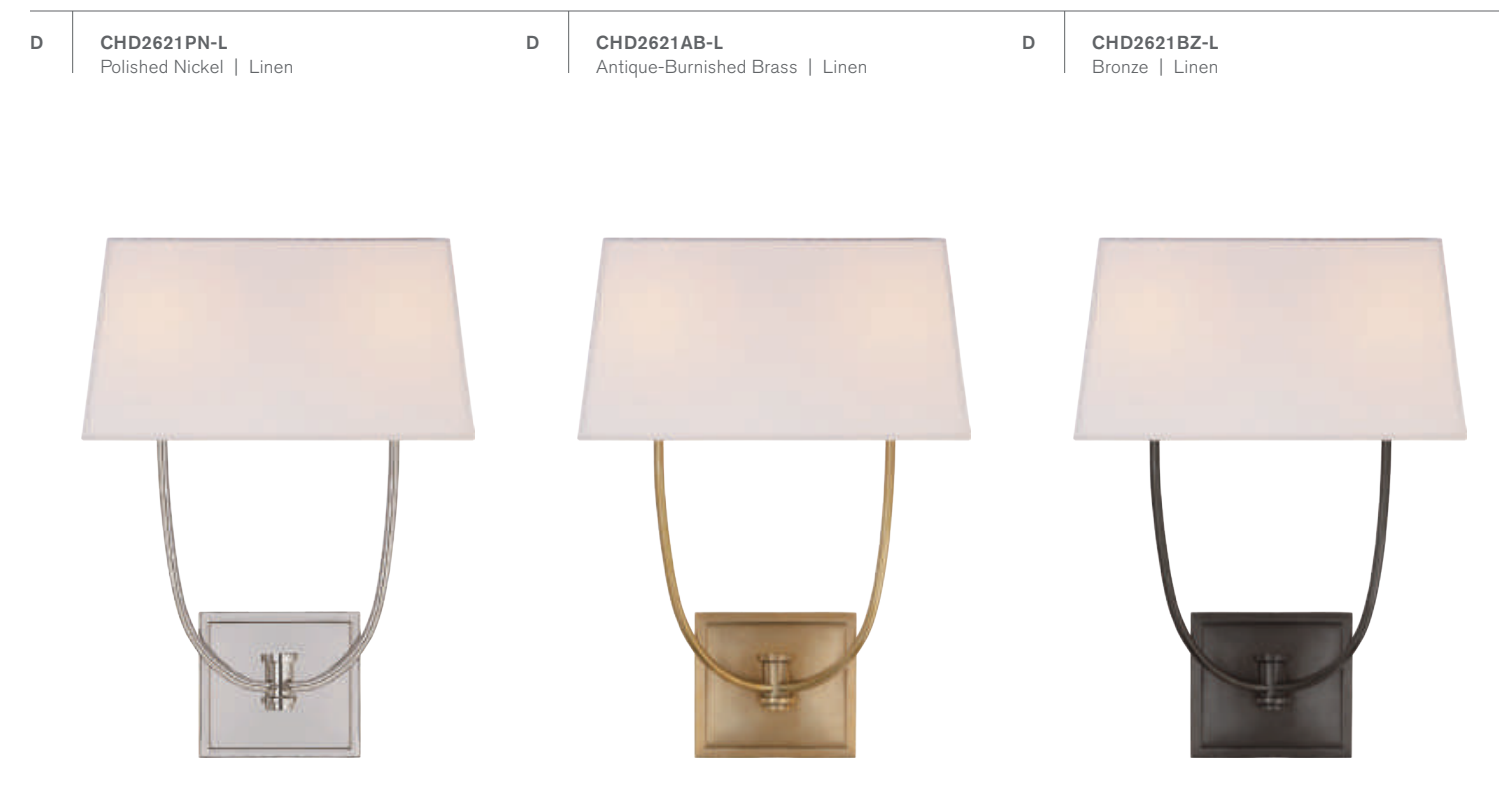

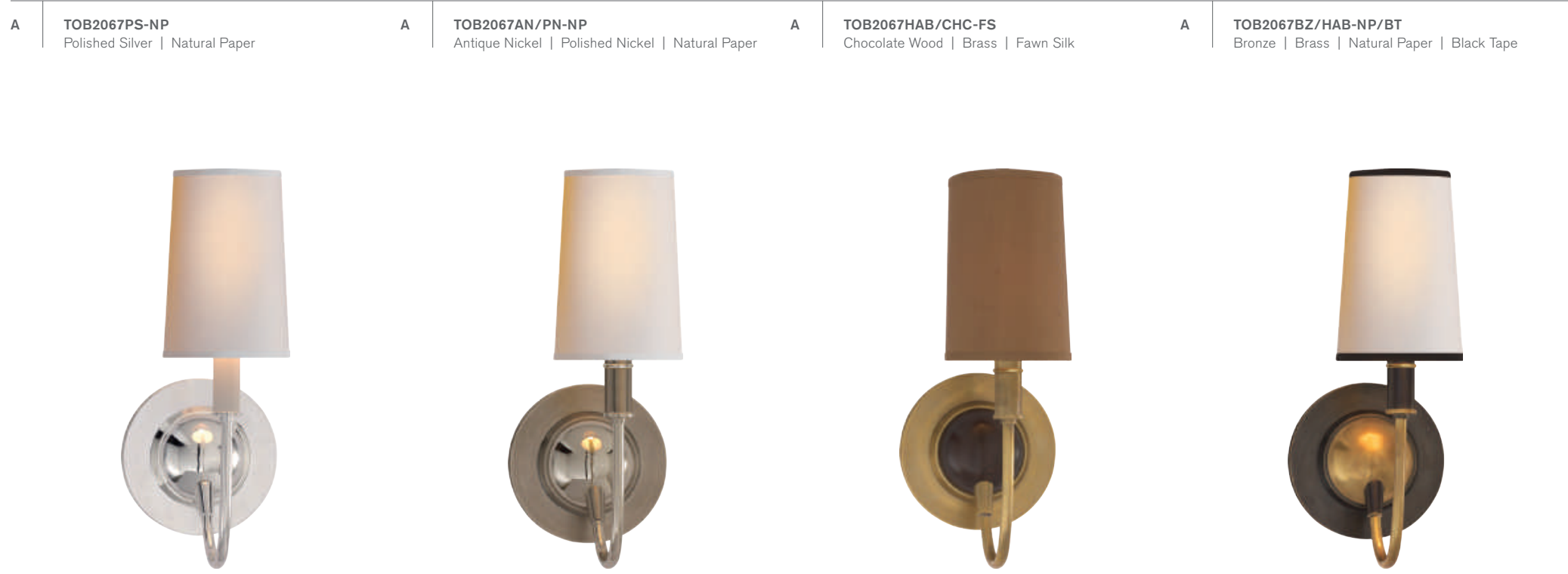

opposite page

**A ELKINS SCONCE**  
THOMAS O'BRIEN

**TOB2067**  
H: 12.75" | W: 5.5" | Ext: 7"  
Backplate: 5.5" Round  
Socket: E12 Candelabra | Bulb: 40 B  
Shade: 3.5" x 4" x 6"

**B ELKINS DOUBLE SCONCE**  
THOMAS O'BRIEN

**TOB2068**  
H: 13.25" | W: 9.5" | Ext: 8.75"  
Backplate: 5.5" Round  
Socket: 2 - E12 Candelabra | Bulb: 2 - 40 B  
Shade: 3.5" x 4" x 6"

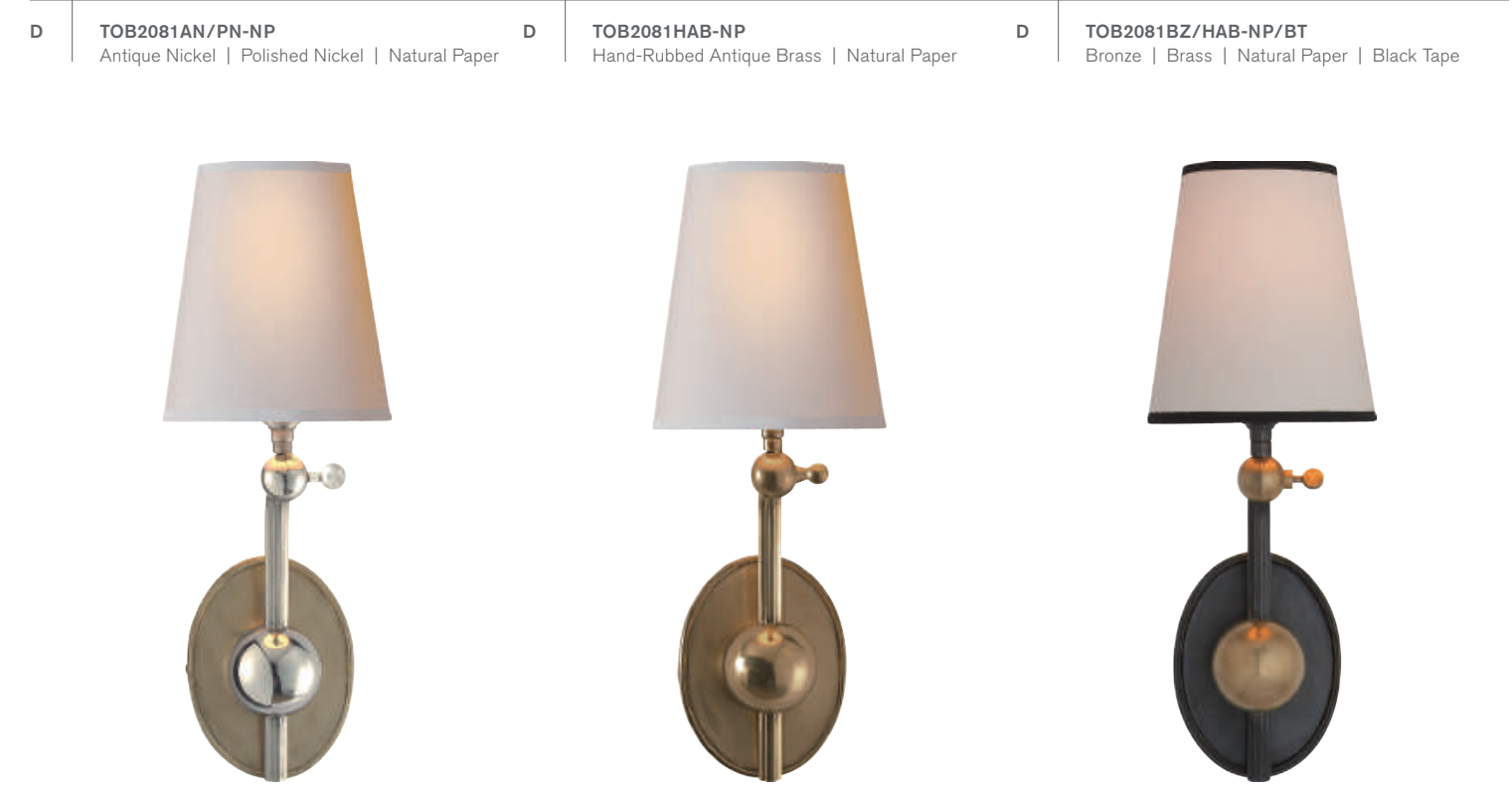
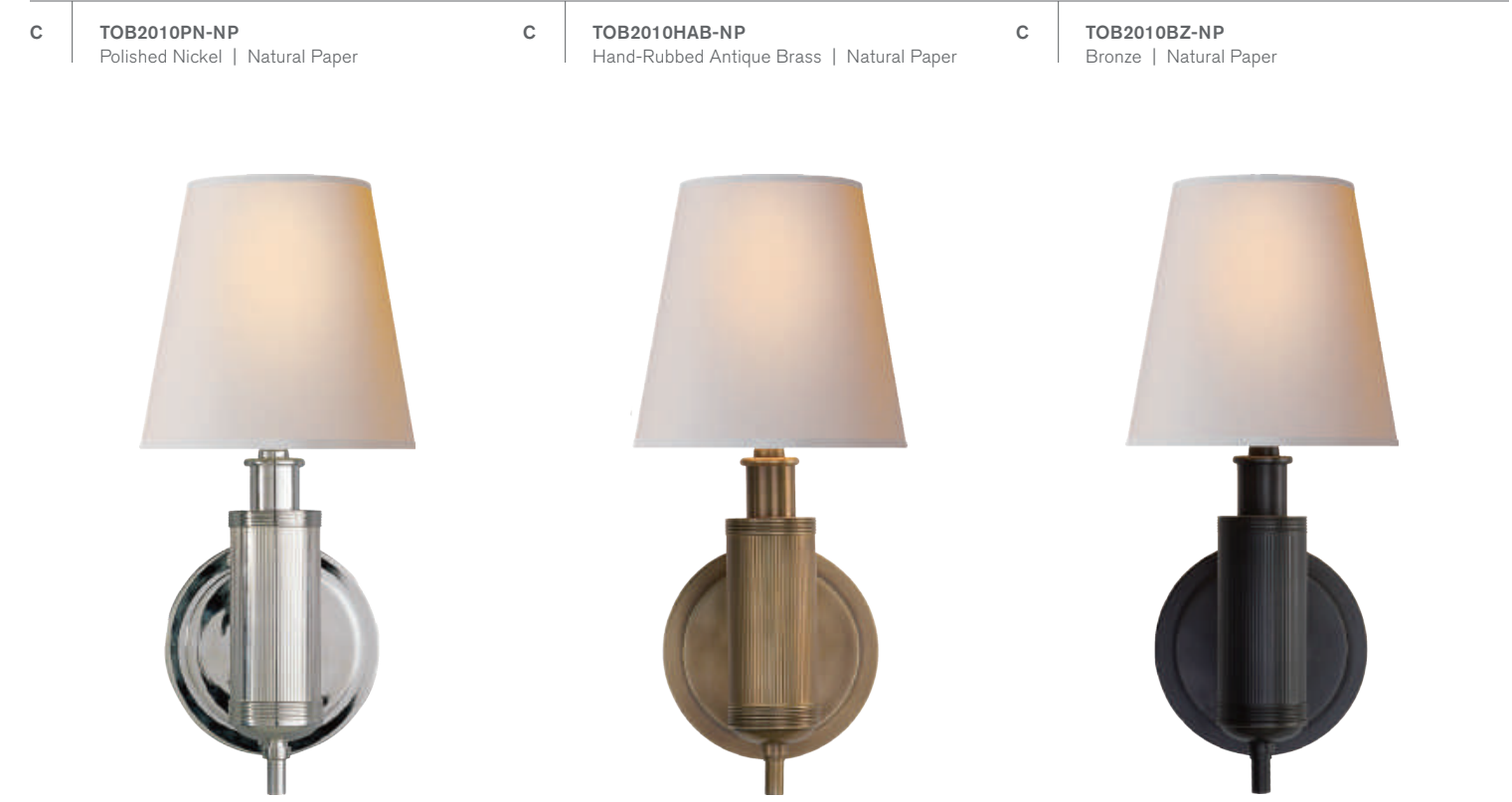

**C LONGACRE SCONCE**  
THOMAS O'BRIEN

**TOB2010**  
H: 14" | W: 6" | Ext: 7"  
Backplate: 5" Round  
Socket: E26 Hi-Lo | Bulb: 60 A  
Shade: 4" x 6" x 6"

**D ALTON PIVOTING SCONCE**  
THOMAS O'BRIEN

**TOB2081**  
H: 16.5" | W: 6" | Ext: 8"  
Backplate: 4.5" x 5.75" Oval  
Socket: E26 Hi-Lo | Bulb: 60 A  
Shade: 4" x 6" x 6.5"  
**Additional Options:**  
Bronze | Natural Paper (BZ-NP)  
Polished Nickel | Natural Paper (PN-NP)



**A LYRIC BRANCH SCONCE**  
BARBARA BARRY

**BBL2030**  
H: 19" | W: 7.5" | Ext: 8"  
Backplate: 4.25" x 6.5" Rec.  
Socket: E26 Keyless | Bulb: 75 A  
Shade: 7" x 7.5" x 7.75"



**B SIMPLE SCALLOP WALL SCONCE**  
BARBARA BARRY

**BBL2017**  
H: 16" | W: 9.25" | Ext: 10.5"  
Backplate: 4.5" x 7" Oval  
Socket: E26 Keyless | Bulb: 75 A  
Shade: 8.75" x 9.25" x 8" Oval



**B BBL2017SS-S**  
Soft Silver | Silk

**B** TOB2126PN-NP  
Polished Nickel | Natural Paper



**A** REED SINGLE SCONCE  
THOMAS O'BRIEN

**TOB2125**  
H: 13" | W: 5" | Ext: 10.5"  
Backplate: 4.5" Round  
Socket: E12 Candelabra | Bulb: 40 B  
Shade: 4" x 5" x 6"  
**Additional Options:**  
Polished Silver | Natural Paper (PS-NP)

**A** TOB2125PN-NP  
Polished Nickel | Natural Paper



**A** TOB2125AN-NP  
Antique Nickel | Natural Paper



**A** TOB2125HAB-NP  
Hand-Rubbed Antique Brass | Natural Paper



**A** TOB2125BZ-NP  
Bronze | Natural Paper



**B** REED DOUBLE SCONCE  
THOMAS O'BRIEN

**TOB2126**  
H: 13" | W: 15" | Ext: 8.5"  
Backplate: 4.5" Round  
Socket: 2 - E12 Candelabra | Bulb: 2 - 40 B  
Shade: 4" x 5" x 6"  
**Additional Options:**  
Antique Nickel | Natural Paper (AN-NP)  
Polished Silver | Natural Paper (PS-NP)

**B** TOB2126PN-NP  
Polished Nickel | Natural Paper



**B** TOB2126HAB-NP  
Hand-Rubbed Antique Brass | Natural Paper



**B** TOB2126BZ-NP  
Bronze | Natural Paper



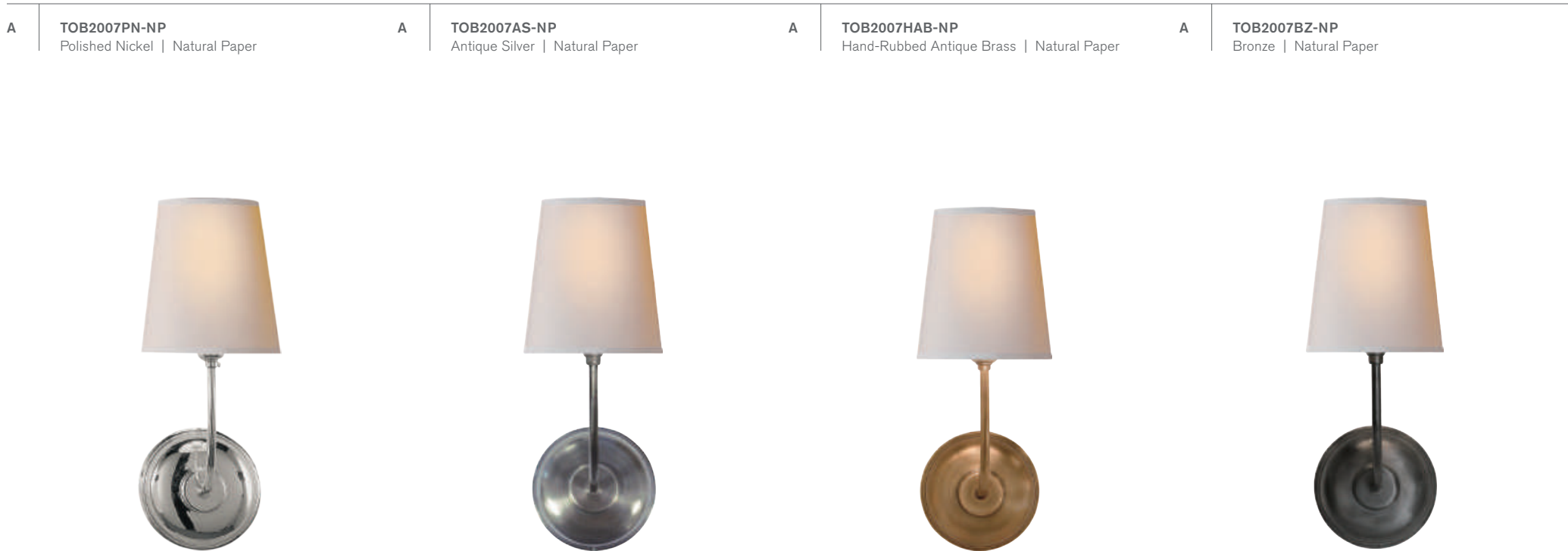

**B** **TOB2009HAB-NP**  
Hand-Rubbed Antique Brass | Natural Paper

**B** **TOB2009BZ-NP**  
Bronze | Natural Paper



**A** **VENDOME SINGLE SCONCE**  
THOMAS O'BRIEN

**TOB2007**  
H: 14" | W: 5.5" | Ext: 8.5"  
Backplate: 5.25" Round  
Socket: E26 Keyless | Bulb: 60 A  
Shade: 4" x 5.5" x 6"

**B** **VENDOME TRIPLE SCONCE**  
THOMAS O'BRIEN

**TOB2009**  
H: 14" | W: 22" | Ext: 11"  
Backplate: 5.25" Round  
Socket: 3 - E26 Keyless | Bulb: 3 - 60 A  
Shade: 4" x 5.5" x 6"  
**Additional Options:**  
Antique Silver | Natural Paper (AS-NP)  
Polished Nickel | Natural Paper (PN-NP)

opposite page

**C** **VENDOME DOUBLE SCONCE**  
THOMAS O'BRIEN

**TOB2008**  
H: 14" | W: 18" | Ext: 9"  
Backplate: 5.25" Round  
Socket: 2 - E26 Keyless | Bulb: 2 - 60 A  
Shade: 4" x 5.5" x 6"  
**Additional Options:**  
Antique Silver | Natural Paper (AS-NP)

**C** **TOB2008BZ-NP**  
Bronze | Natural Paper



**C** **TOB2008PN-NP**  
Polished Nickel | Natural Paper



**C** **TOB2008HAB-NP**  
Hand-Rubbed Antique Brass | Natural Paper





**A FRENCH CUFF SCONCE**  
BARBARA BARRY

**A BBL2035PN-S**  
Polished Nickel | Silk

**BBL2035**  
H: 14" | W: 8" | Ext: 8.75"  
Backplate: 4.75" Round  
Socket: E26 Keyless | Bulb: 75 A  
Shade: 7.5" x 8" x 8.5"

**B GRACEFUL RIBBON DOUBLE SCONCE**  
BARBARA BARRY

**BBL2039**  
H: 13" | W: 12.5" | Ext: 7.5"  
Backplate: 3.75" x 6.75" Oval  
Socket: 2 - E26 Keyless | Bulb: 2 - 60 A  
Shade: 12.5" x 12.5" x 8" Oval  
**Additional Options:**  
Soft Silver | Silk (SS-S)  
\* Requires Smaller Outlet Box

**A BBL2035SS-S**  
Soft Silver | Silk

**A BBL2035PN-S**  
Polished Nickel | Silk

**A BBL2035SB-S**  
Soft Brass | Silk

**A BBL2035BZ-S**  
Bronze | Silk



**B BBL2039PWT-S**  
Pewter | Silk

**B BBL2039SB-S**  
Soft Brass | Silk

**B BBL2039BZ-S**  
Bronze | Silk



**A SIMONE SMALL SCONCE**  
THOMAS O'BRIEN

**TOB2630**  
H: 17.5" | W: 10.25" | Ext: 6.5"  
Backplate: 4" Square  
Socket: 2 - E12 Candelabra | Bulb: 2 - 40 B  
Shade: 8" x 10.5" x 8" Shield

**A TOB2630PN-L**  
Polished Nickel | Linen



**A TOB2630HAB-L**  
Hand-Rubbed Antique Brass | Linen



**A TOB2630BZ/HAB-L**  
Bronze | Hand-Rubbed Antique Brass | Linen



**B RING FORM LARGE WALL SCONCE**  
E. F. CHAPMAN

**CHD2970**  
H: 19" | W: 13.5" | Ext: 7"  
Backplate: 4.25" x 6.5" Rec.  
Socket: E26 Hi-Lo | Bulb: 75 A  
Shade: 10.5" x 13.5" x 8.5" Rec. Shield  
**Additional Options:**  
Gild | Natural Paper (G-NP)  
©EFC DESIGNS

**B CHD2970ALB-NP**  
Alabaster | Natural Paper



**B CHD2970PN-NP**  
Polished Nickel | Natural Paper



**B CHD2970AB-NP**  
Antique-Burnished Brass | Natural Paper



**B CHD2970BZ-NP**  
Bronze | Natural Paper



**C COOPER SCONCE**  
STUDIO VC

**S2090**  
H: 21" | W: 9" | Ext: 4"  
Backplate: 4.25" Square  
Socket: E12 Candelabra | Bulb: 60 B  
Shade: 9" x 9" x 9.5" Rec.

**C S2090PN-NP**  
Polished Nickel | Natural Paper



**C S2090HAB-NP**  
Hand-Rubbed Antique Brass | Natural Paper



**C S2090BZ-NP**  
Bronze | Natural Paper



**D MODERN DARLANA BOUILLOTTE SCONCE**  
E. F. CHAPMAN

**CHD2266**  
H: 22.5" | W: 12.5" | Ext: 6.5"  
Backplate: 4" Square  
Socket: 2 - E12 Candelabra | Bulb: 2 - 40 C  
Shade: 12" x 12.5" x 7" Shield  
©EFC DESIGNS

**D CHD2266PN-NP**  
Polished Nickel | Natural Paper



**D CHD2266AB-NP**  
Antique-Burnished Brass | Natural Paper



**D CHD2266BZ-NP**  
Bronze | Natural Paper





**A** | **BBL2036CW-L**  
China White | Polished Nickel | Linen



**A** | **BBL2036EBO-L**  
Ebony Resin | Soft Brass | Linen



**A** | **BBL2036EBO-L**  
Ebony Resin | Soft Brass | Linen



opposite page

**A** | **REFINED RIB SCONCE**  
BARBARA BARRY

**BBL2036**  
H: 16.75" | W: 7.75" | Ext: 8.5"  
Backplate: 4" x 6" Rec.  
Socket: E26 Keyless | Bulb: 75 A  
Shade: 7.25" x 7.75" x 8.25"

**B** | **BBL2132SS-L**  
Soft Silver | Linen



**B** | **BBL2132SB-L**  
Soft Brass | Linen



**B** | **BBL2132BZ-L**  
Bronze | Linen



**C** | **BBL2130SS-L**  
Soft Silver | Linen



**C** | **BBL2130SB-L**  
Soft Brass | Linen



**C** | **BBL2130BZ-L**  
Bronze | Linen



**B** | **CLOUT SMALL SCONCE**  
BARBARA BARRY

**BBL2132**  
H: 15" | W: 5.25" | Ext: 8.25"  
Backplate: 2.75" x 4.5" Rec.  
Socket: E12 Candelabra | Bulb: 60 B  
Shade: 5" x 5.25" x 7"

**C** | **CLOUT TAIL SCONCE**  
BARBARA BARRY

**BBL2130**  
H: 19.25" | W: 7.5" | Ext: 9"  
Backplate: 4.75" Round  
Socket: E26 Keyless | Bulb: 60 A  
Shade: 7" x 7.5" x 8"

<p><b>A</b> <b>TOB2017PN-NP</b> Polished Nickel   Natural Paper</p> 	<p><b>A</b> <b>TOB2017HAB-NP</b> Hand-Rubbed Antique Brass   Natural Paper</p> 
---	--

**A** **ZIYI SINGLE SCONCE**  
THOMAS O'BRIEN

**TOB2017**  
H: 13.75" | W: 4.25" | Ext: 5.5"  
Backplate: 4.25" Round  
Socket: E12 Candelabra | Bulb: 25 B  
Shade: 3" x 3.5" x 7.5"  
**Additional Options:**  
Bronze | Natural Paper (BZ-NP)  
\* Requires Smaller Outlet Box

**B** **LARABEE SINGLE SCONCE**  
KATE SPADE NEW YORK

**KS2035**  
H: 16" | W: 5" | Ext: 9"  
Backplate: 4.5" Round  
Socket: E12 Candelabra | Bulb: 40 C  
Shade: 4" x 4" x 10"  
**Additional Options:**  
Gun Metal | Linen (GM-L)

**C** **ARN2018PN/CG-L**  
Polished Nickel | Crystal | Linen





**C** **ARN2018HAB/CG-L**  
Hand-Rubbed Antique Brass | Crystal | Linen



**C** **ARN2018BZ-L**  
Bronze | Linen



<p><b>B</b> <b>KS2035PN-L</b> Polished Nickel   Linen</p> 	<p><b>B</b> <b>KS2035SB-L</b> Soft Brass   Linen</p> 
--	---

**C** **DRUNMORE SINGLE SCONCE**  
AERIN

**ARN2018**  
H: 14.25" | W: 4.5" | Ext: 6.75"  
Backplate: 4.5" Round  
Socket: E12 Candelabra | Bulb: 40 B  
Shade: 4.5" x 4.5" x 8.5"  
**Additional Options:**  
Bronze | Crystal | Linen (BZ/CG-L)

**C** **ARN2018PN-L**  
Polished Nickel | Linen



**C** **ARN2018HAB-L**  
Hand-Rubbed Antique Brass | Linen

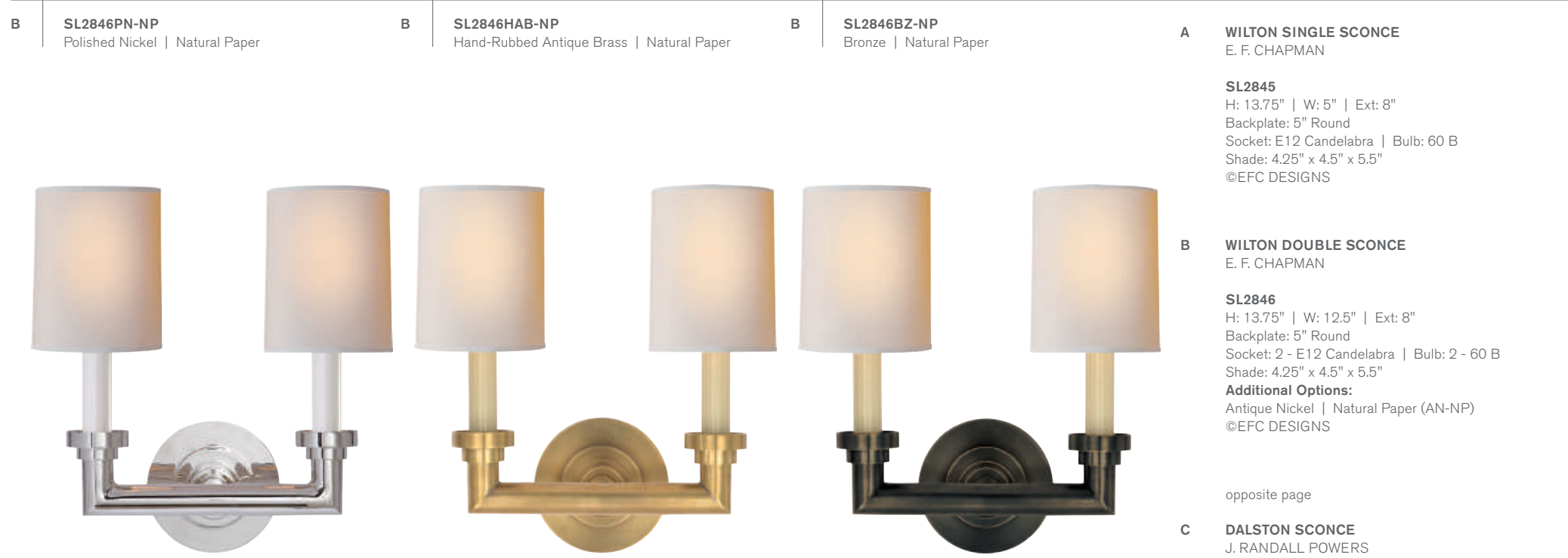
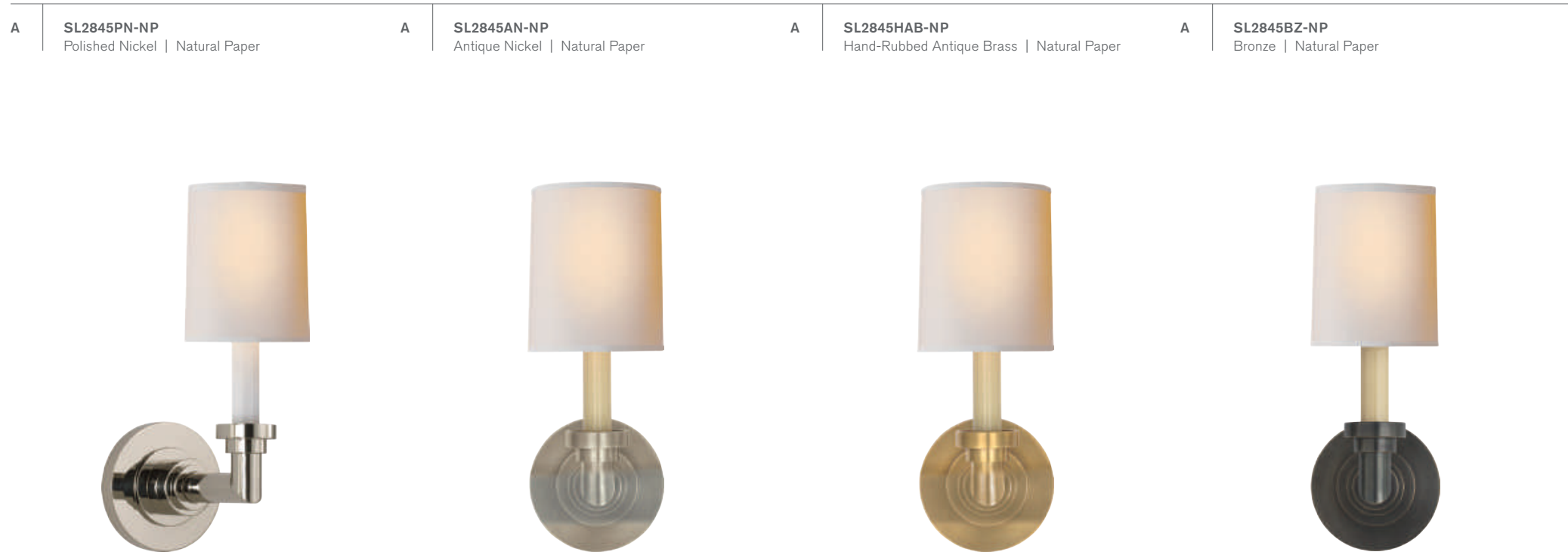

**A WILTON SINGLE SCONCE**  
E. F. CHAPMAN

**SL2845**  
H: 13.75" | W: 5" | Ext: 8"  
Backplate: 5" Round  
Socket: E12 Candelabra | Bulb: 60 B  
Shade: 4.25" x 4.5" x 5.5"  
©EFC DESIGNS

**B WILTON DOUBLE SCONCE**  
E. F. CHAPMAN

**SL2846**  
H: 13.75" | W: 12.5" | Ext: 8"  
Backplate: 5" Round  
Socket: 2 - E12 Candelabra | Bulb: 2 - 60 B  
Shade: 4.25" x 4.5" x 5.5"  
**Additional Options:**  
Antique Nickel | Natural Paper (AN-NP)  
©EFC DESIGNS

opposite page

**C DALSTON SCONCE**  
J. RANDALL POWERS

**SP2017**  
H: 23.75" | W: 7.5" | Ext: 7.75"  
Backplate: 5" x 9.25" Rec.  
Socket: E26 Keyless | Bulb: 40 A  
Shade: 6.25" x 7.5" x 8"



**C SP2017PN-NP**  
Polished Nickel | Natural Paper



**C SP2017HAB-NP**  
Hand-Rubbed Antique Brass | Natural Paper



**C SP2017BZ-NP**  
Bronze | Natural Paper

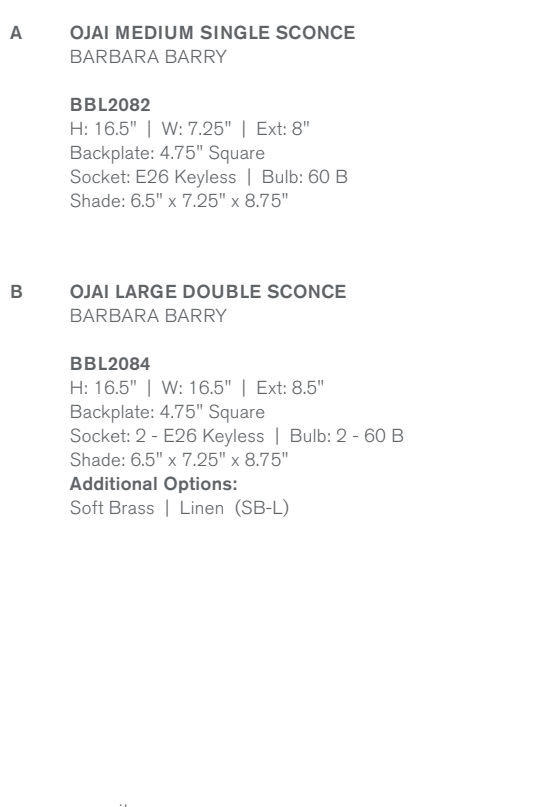
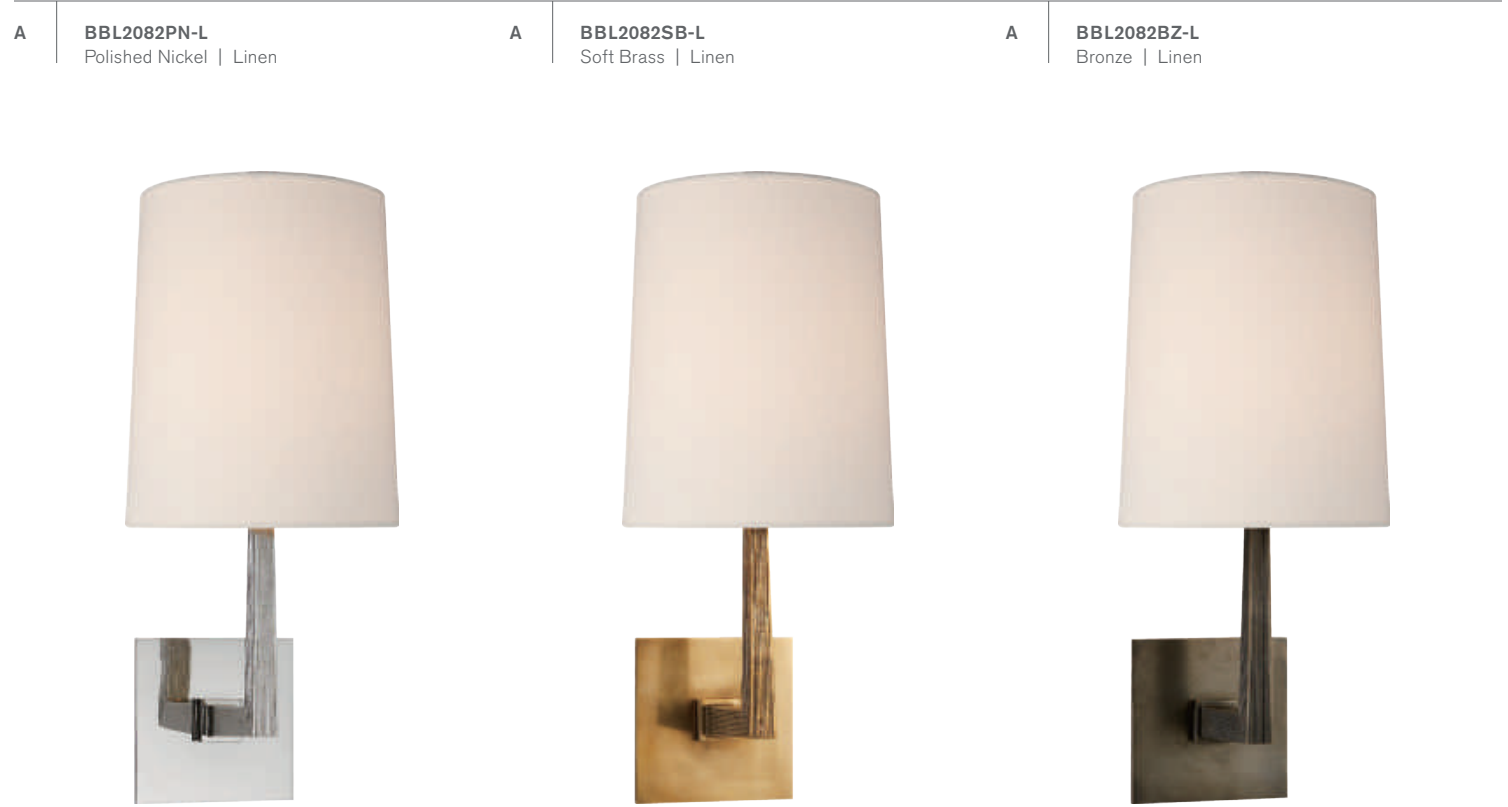

opposite page

**C** | **SQUARE TUBE SINGLE SCONCE**  
E. F. CHAPMAN

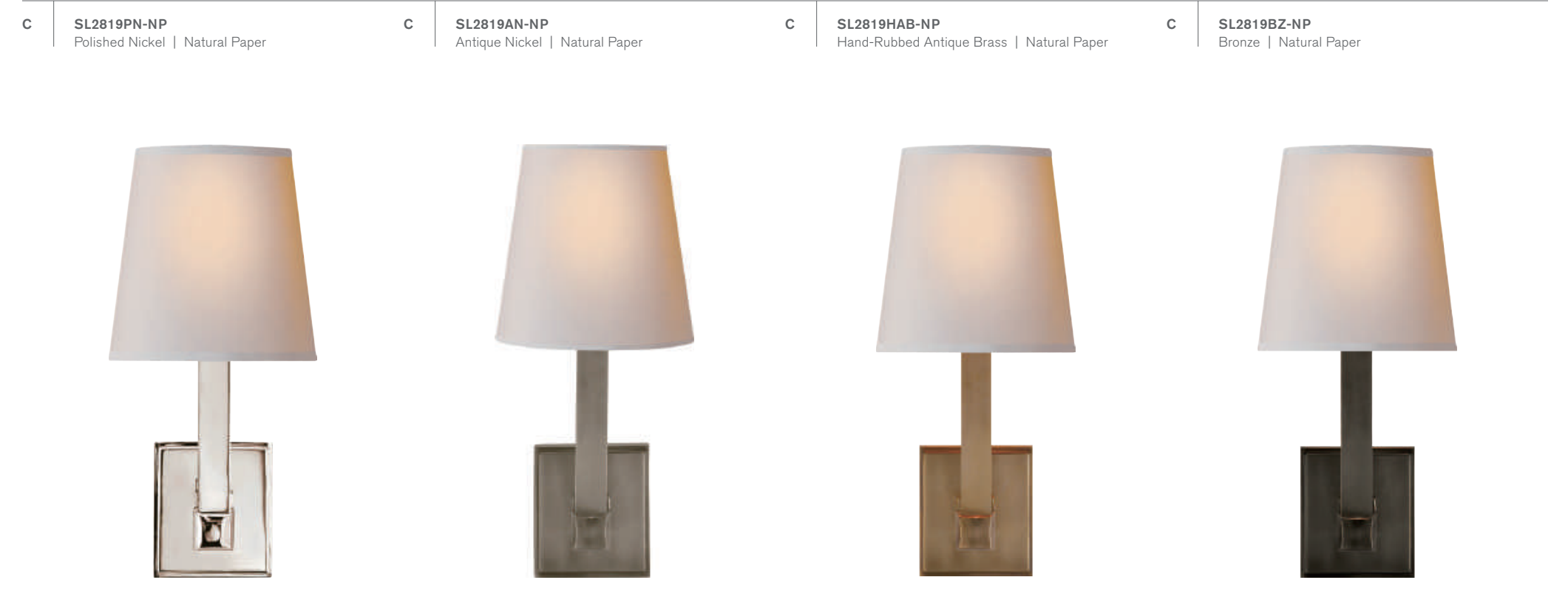
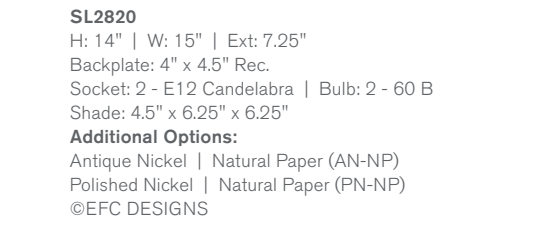
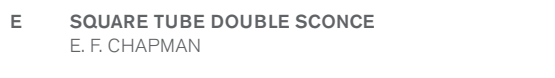
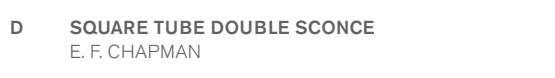
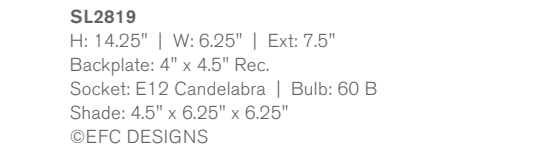

**A** | **S20PN-NPS**  
Polished Nickel | Square Natural Paper



**A** | **S20BS-NPS**  
Brushed Steel | Square Natural Paper



**A** | **S20HAB-NPS**  
Hand-Rubbed Antique Brass | Square Natural Paper



opposite page

**A** | **ARCHITECTURAL WALL SCONCE**  
STUDIO VC

**S20**  
H: 13.5" | W: 7" | Ext: 7"  
Backplate: 4.5" Square  
Socket: E12 Candelabra | Bulb: 40 B  
Shade: 4" x 7" x 6.5" Square  
**Additional Options:**  
Brushed Steel | Natural Paper (BS-NP)  
Hand-Rubbed Antique Brass | Natural Paper (HAB-NP)  
Polished Nickel | Natural Paper (PN-NP)

**B** | **TOB2284PN-L**  
Polished Nickel | Linen



**B** | **TOB2284HAB-L**  
Hand-Rubbed Antique Brass | Linen



**B** | **TOB2284BZ/HAB-L**  
Bronze | Hand-Rubbed Antique Brass | Linen



**C** | **TOB2283PN-L**  
Polished Nickel | Linen



**C** | **TOB2283HAB-L**  
Hand-Rubbed Antique Brass | Linen



**C** | **TOB2283BZ/HAB-L**  
Bronze | Hand-Rubbed Antique Brass | Linen



**B** | **WATSON SMALL SCONCE**  
THOMAS O'BRIEN

**TOB2284**  
H: 10.75" | W: 5" | Ext: 6.25"  
Backplate: 3.75" x 5.5" Rec.  
Socket: E12 Candelabra | Bulb: 40 B  
Shade: 3.5" x 5" x 6"

**C** | **WATSON SMALL TAIL SCONCE**  
THOMAS O'BRIEN

**TOB2283**  
H: 13.25" | W: 5" | Ext: 6.5"  
Backplate: 3.75" x 5.5" Rec.  
Socket: E12 Candelabra | Bulb: 40 B  
Shade: 3.5" x 5" x 6"

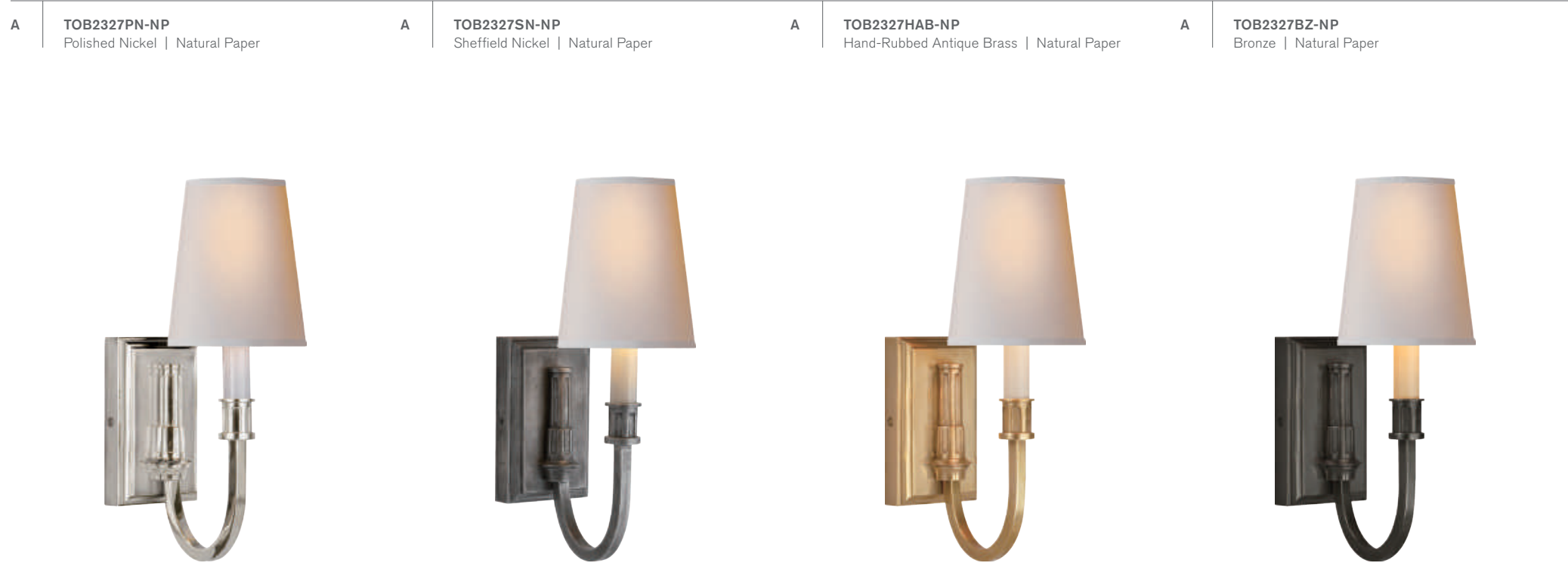

**A** **TOB2327PN-NP** Polished Nickel | Natural Paper  
**A** **TOB2327SN-NP** Sheffield Nickel | Natural Paper  
**A** **TOB2327HAB-NP** Hand-Rubbed Antique Brass | Natural Paper  
**A** **TOB2327BZ-NP** Bronze | Natural Paper

opposite page

**A MODERN LIBRARY SINGLE SCONCE**  
THOMAS O'BRIEN

**TOB2327**  
H: 14" | W: 5" | Ext: 7.75"  
Backplate: 4" x 6.5" Rec.  
Socket: E12 Candelabra | Bulb: 40 B  
Shade: 3.5" x 5" x 6"

**B MODERN LIBRARY DOUBLE SCONCE**  
THOMAS O'BRIEN

**TOB2328**  
H: 14.5" | W: 11.5" | Ext: 8.25"  
Backplate: 4" x 6.5" Rec.  
Socket: 2 - E12 Candelabra | Bulb: 2 - 40 B  
Shade: 3.5" x 5" x 6"

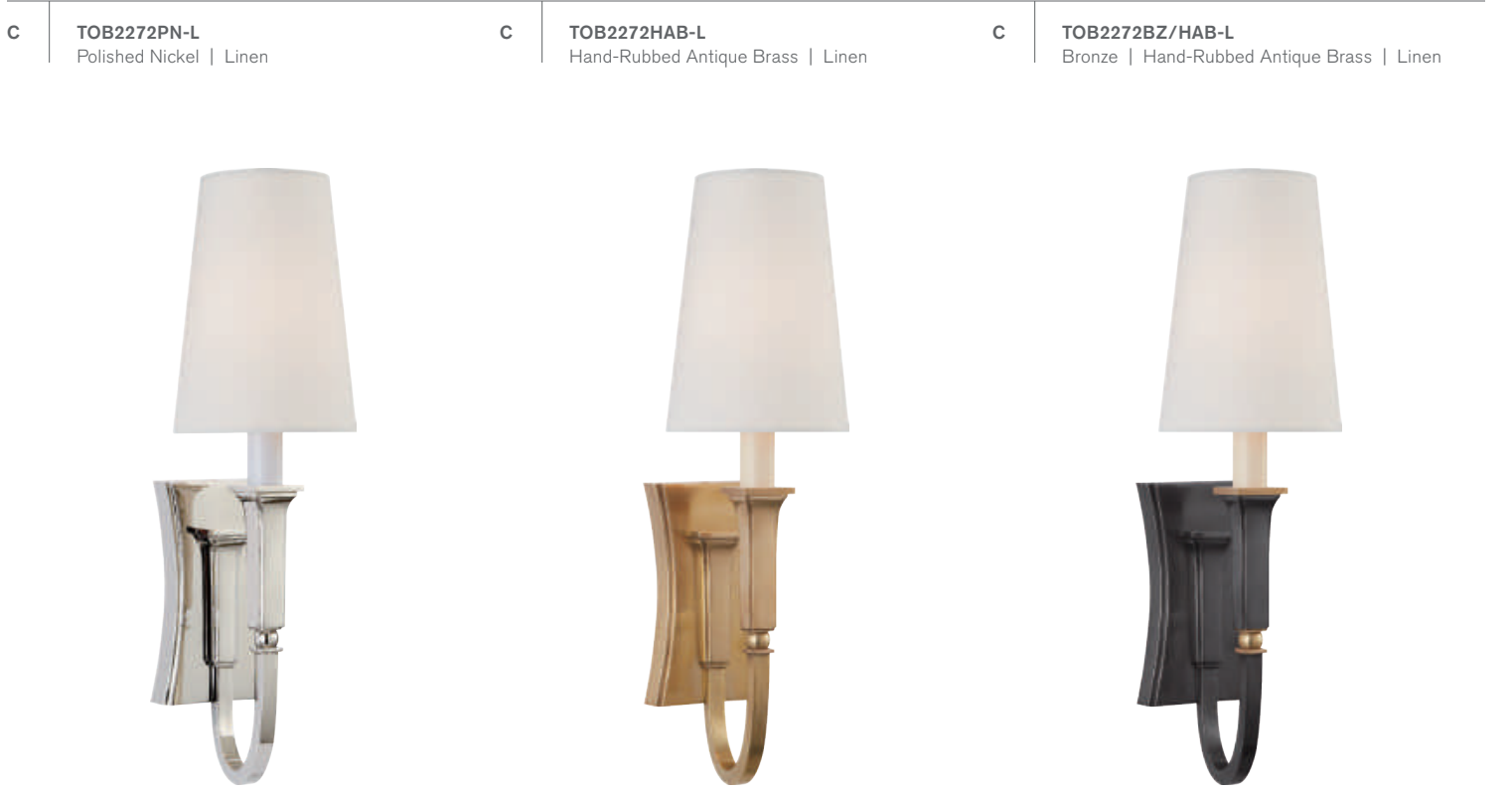

**C** **TOB2272PN-L** Polished Nickel | Linen  
**C** **TOB2272HAB-L** Hand-Rubbed Antique Brass | Linen  
**C** **TOB2272BZ/HAB-L** Bronze | Hand-Rubbed Antique Brass | Linen

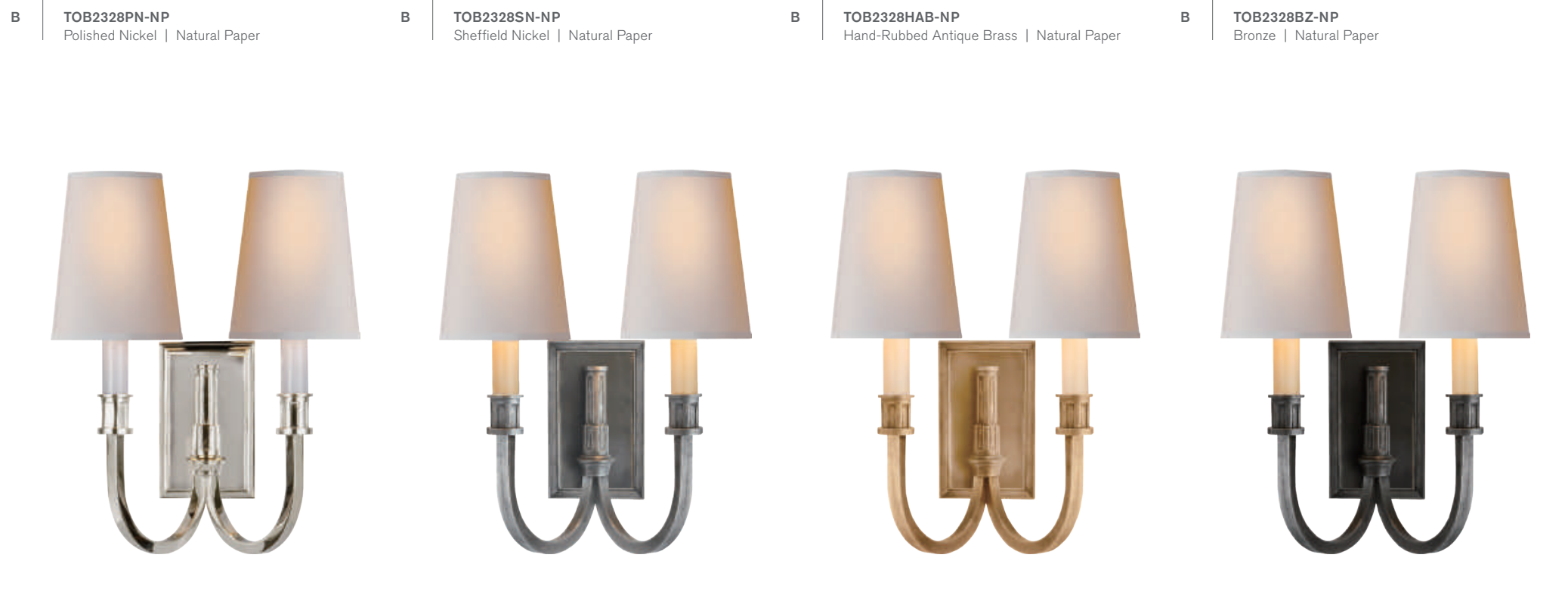

**B** **TOB2328PN-NP** Polished Nickel | Natural Paper  
**B** **TOB2328SN-NP** Sheffield Nickel | Natural Paper  
**B** **TOB2328HAB-NP** Hand-Rubbed Antique Brass | Natural Paper  
**B** **TOB2328BZ-NP** Bronze | Natural Paper

**C DELPHIA SMALL SINGLE SCONCE**  
THOMAS O'BRIEN

**TOB2272**  
H: 17.25" | W: 5" | Ext: 7"  
Backplate: 3.5" x 6.5" Rec.  
Socket: E12 Candelabra | Bulb: 40 B  
Shade: 3" x 5" x 7"  
\* Requires Smaller Outlet Box

**D DELPHIA LARGE DOUBLE ARM SCONCE**  
THOMAS O'BRIEN

**TOB2273**  
H: 17" | W: 12.5" | Ext: 6.5"  
Backplate: 3.5" x 6.5" Rec.  
Socket: 2 - E12 Candelabra | Bulb: 2 - 40 B  
Shade: 3" x 5" x 7"  
\* Requires Smaller Outlet Box

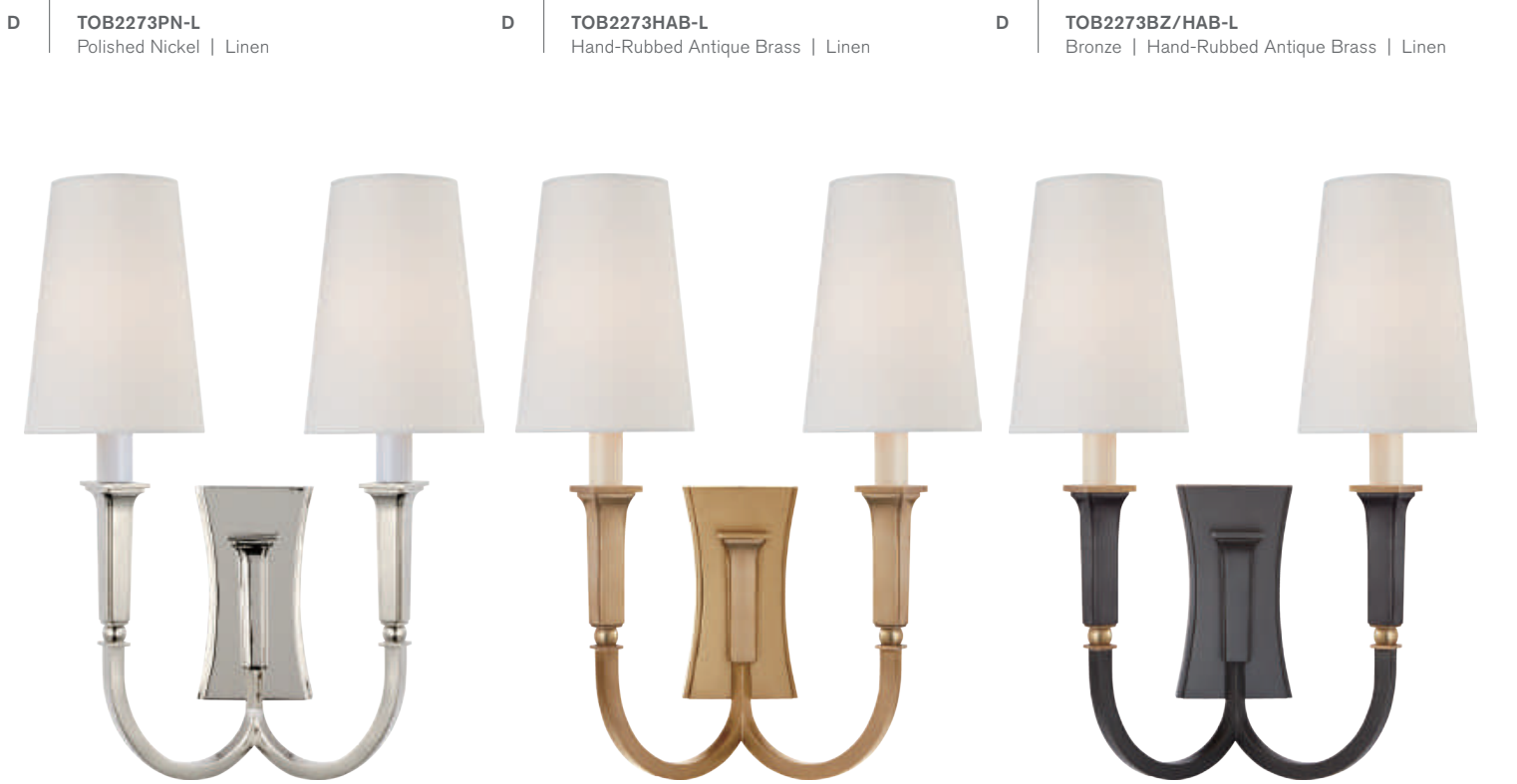

**D** **TOB2273PN-L** Polished Nickel | Linen  
**D** **TOB2273HAB-L** Hand-Rubbed Antique Brass | Linen  
**D** **TOB2273BZ/HAB-L** Bronze | Hand-Rubbed Antique Brass | Linen



opposite page

**A SINGLE SWING ARM SCONCE**  
STUDIO VC

**S2005**  
H: 12" | W: 6" | Ext: 7"  
Backplate: 3.5" x 4.5" Rec.  
Socket: E12 Candelabra | Bulb: 40 B  
Shade: 3" x 6" x 5"  
\* Requires Smaller Outlet Box

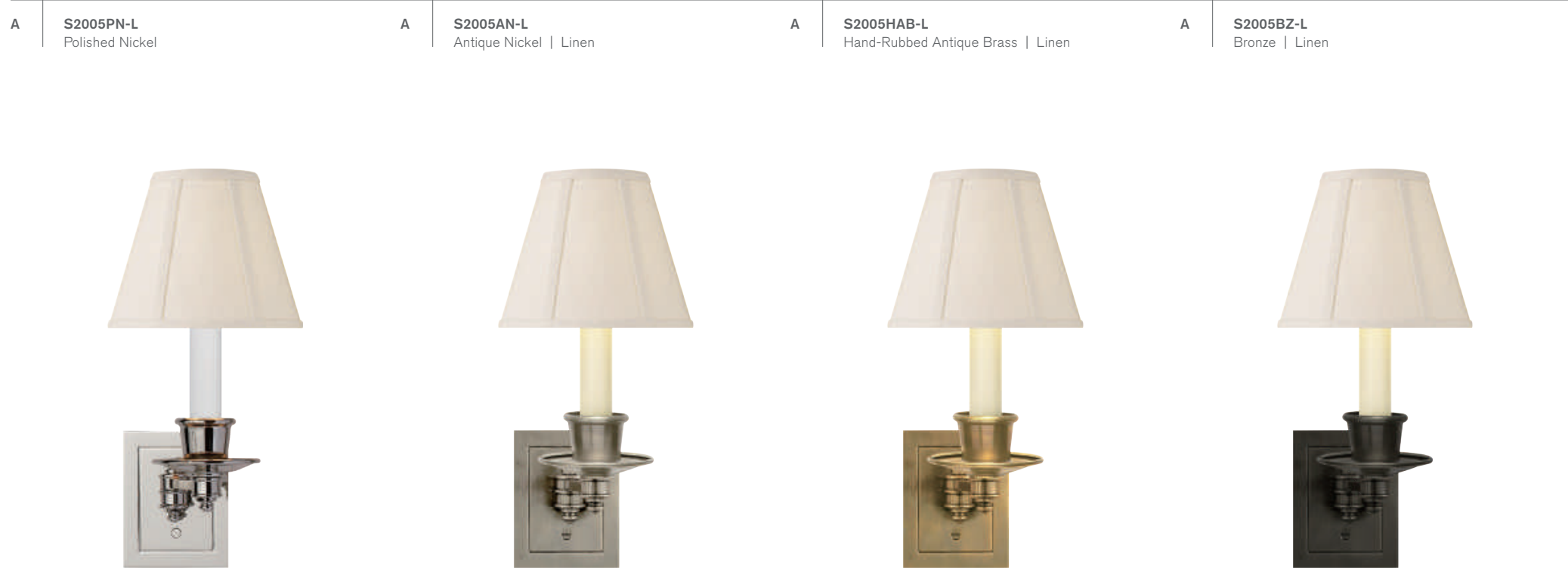
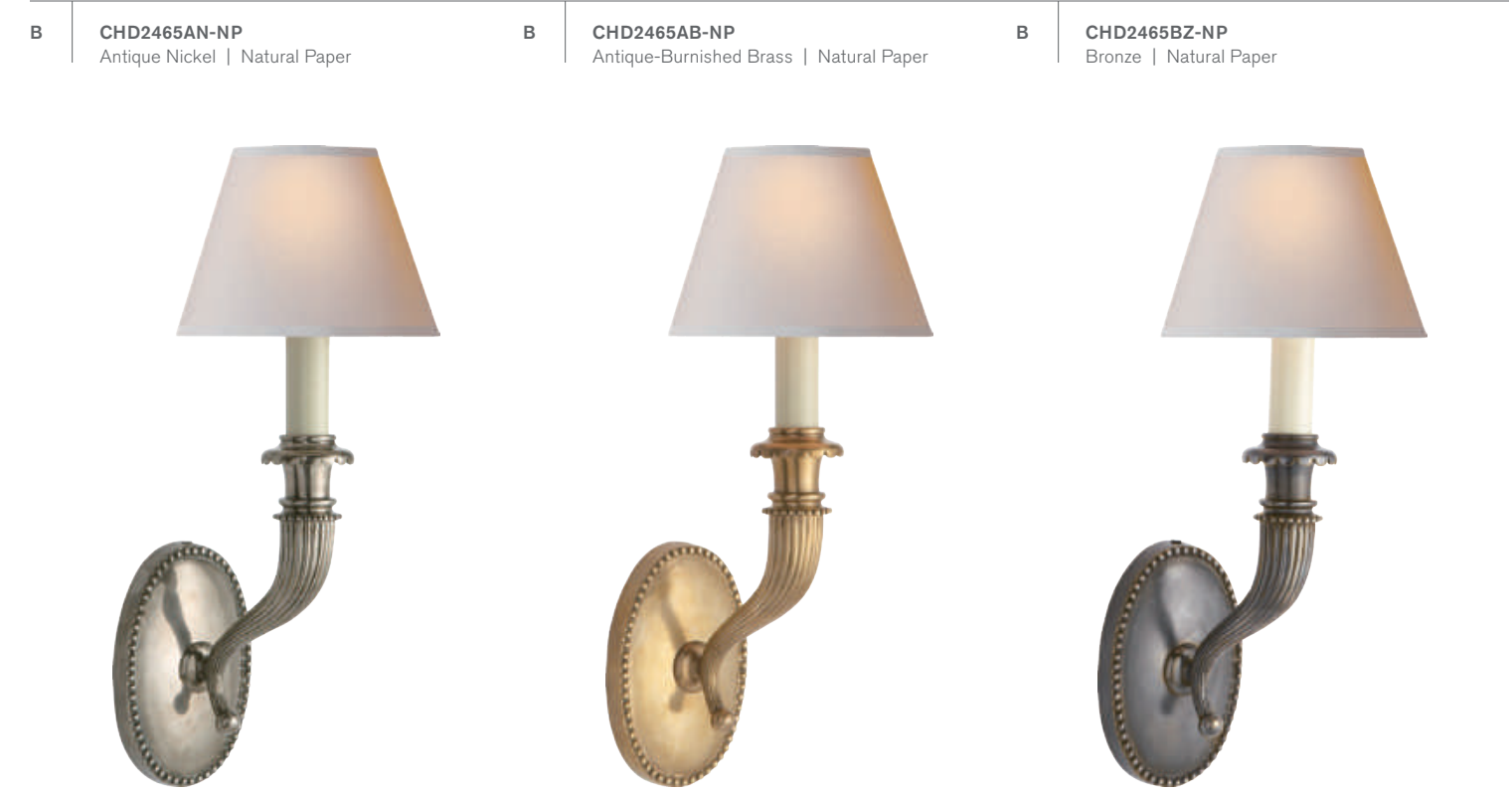

**B FLUTED HORN SINGLE SCONCE**  
E. F. CHAPMAN

**CHD2465**  
H: 15" | W: 6" | Ext: 7.5"  
Backplate: 4" x 6" Oval  
Socket: E12 Candelabra | Bulb: 60 C  
Shade: 3.25" x 6" x 4.25"  
©EFC DESIGNS

**C FLUTED HORN DOUBLE SCONCE**  
E. F. CHAPMAN

**CHD2466**  
H: 14.5" | W: 9" | Ext: 5.25"  
Backplate: 4" x 6" Oval  
Socket: 2 - E12 Candelabra | Bulb: 2 - 60 C  
\* Use 40 Bulb Frosted Type "B" with Clip On Shade  
©EFC DESIGNS

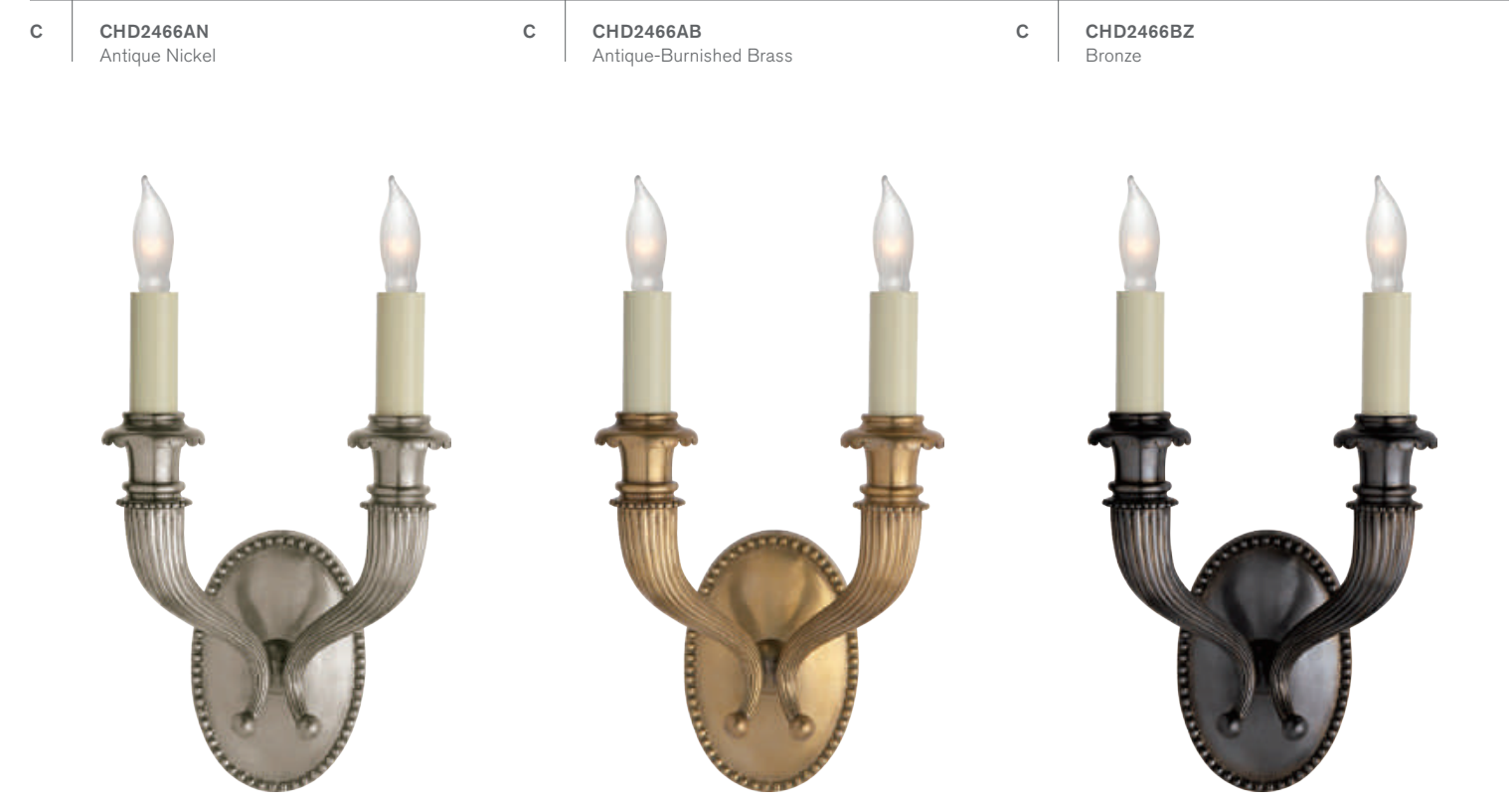

A	<b>CHD1138AN</b> Antique Nickel	A	<b>CHD1138AB</b> Antique-Burnished Brass	A	<b>CHD1138BZ</b> Bronze
---	------------------------------------	---	---	---	----------------------------



**A GROSVENOR HOUSE SINGLE SCONCE**  
E. F. CHAPMAN

**CHD1138**  
H: 10.5" | W: 4.5" | Ext: 8"  
Backplate: 4.5" x 6.5" Oval  
Socket: E12 Candelabra | Bulb: 60 C  
**Additional Options:**  
Polished Silver (PS)  
Sheffield Nickel (SN)  
\* CHS109S Shade Sold Separately  
\* Use 40 Bulb Frosted Type "B" with Clip On Shade  
©EFC DESIGNS

**B GROSVENOR HOUSE DOUBLE SCONCE**  
E. F. CHAPMAN

**CHD1139**  
H: 10.5" | W: 10.5" | Ext: 8"  
Backplate: 4.5" x 6.5" Oval  
Socket: 2 - E12 Candelabra | Bulb: 2 - 60 C  
**Additional Options:**  
Polished Silver (PS)  
Sheffield Nickel (SN)  
\* CHS109S Shade Sold Separately  
\* Use 40 Bulb Frosted Type "B" with Clip On Shade  
©EFC DESIGNS

C	<b>TOB2120PS-NP</b> Polished Silver   Natural Paper	C	<b>TOB2120HAB-NP</b> Hand-Rubbed Antique Brass   Natural Paper	C	<b>TOB2120BZ-NP</b> Bronze   Natural Paper
---	--	---	---	---	---



D	<b>TOB2121PS-NP</b> Polished Silver   Natural Paper	D	<b>TOB2121HAB-NP</b> Hand-Rubbed Antique Brass   Natural Paper	D	<b>TOB2121BZ-NP</b> Bronze   Natural Paper
---	--	---	---	---	---



B	<b>CHD1139AN</b> Antique Nickel	B	<b>CHD1139AB</b> Antique-Burnished Brass	B	<b>CHD1139BZ</b> Bronze
---	------------------------------------	---	---	---	----------------------------



opposite page

**C CHANNING SINGLE SCONCE**  
THOMAS O'BRIEN

**TOB2120**  
H: 14" | W: 6" | Ext: 9.5"  
Backplate: 5.5" x 6.25" Oval  
Socket: E12 Candelabra | Bulb: 40 B  
Shade: NP | 4.5" x 6" x 5.5" Oval

**D CHANNING DOUBLE SCONCE**  
THOMAS O'BRIEN

**TOB2121**  
H: 14" | W: 15" | Ext: 9.5"  
Backplate: 5.5" x 6.25" Oval  
Socket: 2 - E12 Candelabra | Bulb: 2 - 60 B  
Shade: NP | 4.5" x 6" x 5.5" Oval



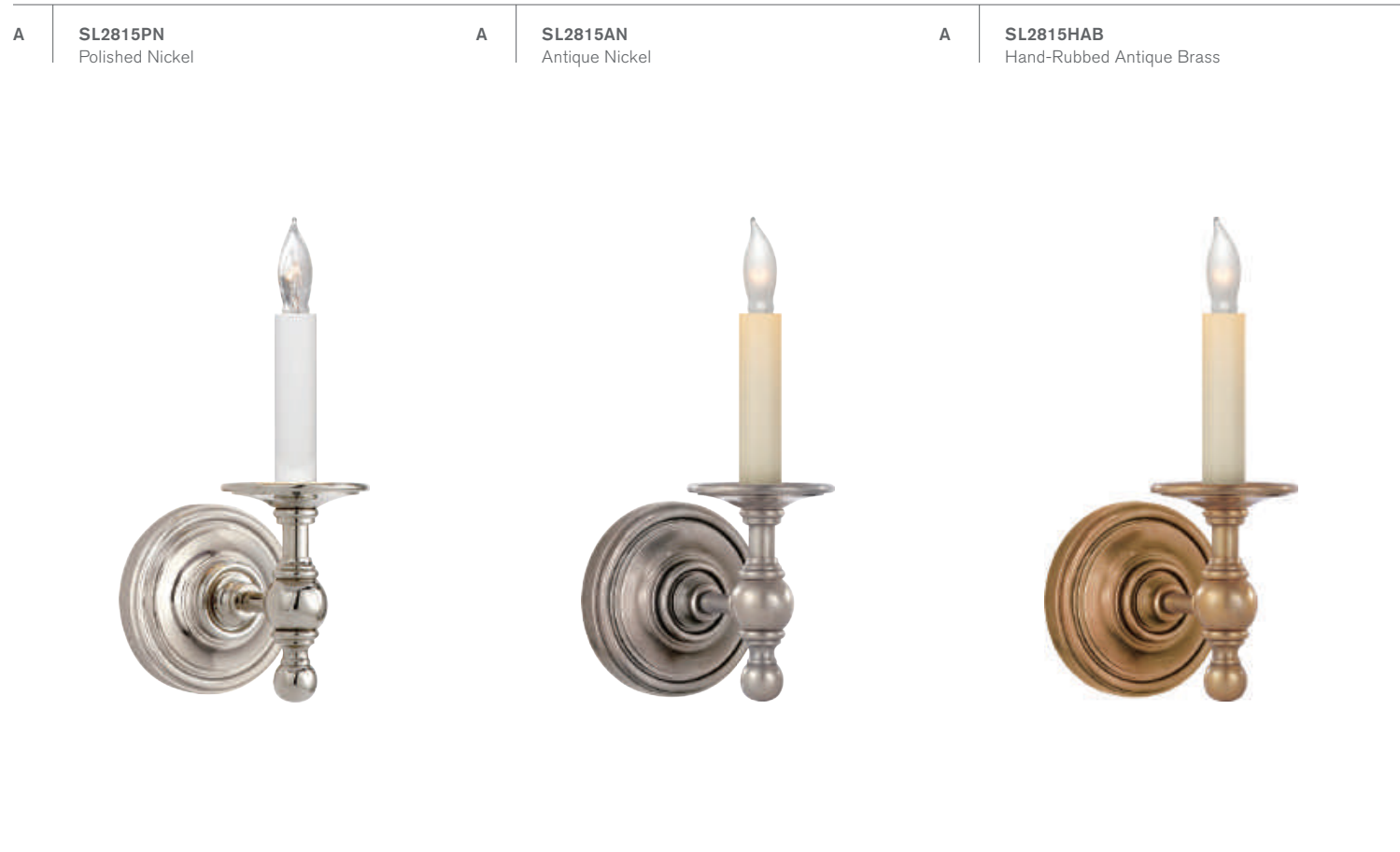

**A** **CLASSIC SINGLE SCONCE**  
E. F. CHAPMAN

**SL2815**  
H: 8" | W: 4.5" | Ext: 7"  
Backplate: 4.5" Round  
Socket: E12 Candelabra | Bulb: 60 C  
**Additional Options:**  
Bronze (BZ)  
\* CHS104NP Shade Sold Separately  
\* Use 40 Bulb Frosted Type "B" with Clip On Shade  
©EFC DESIGNS

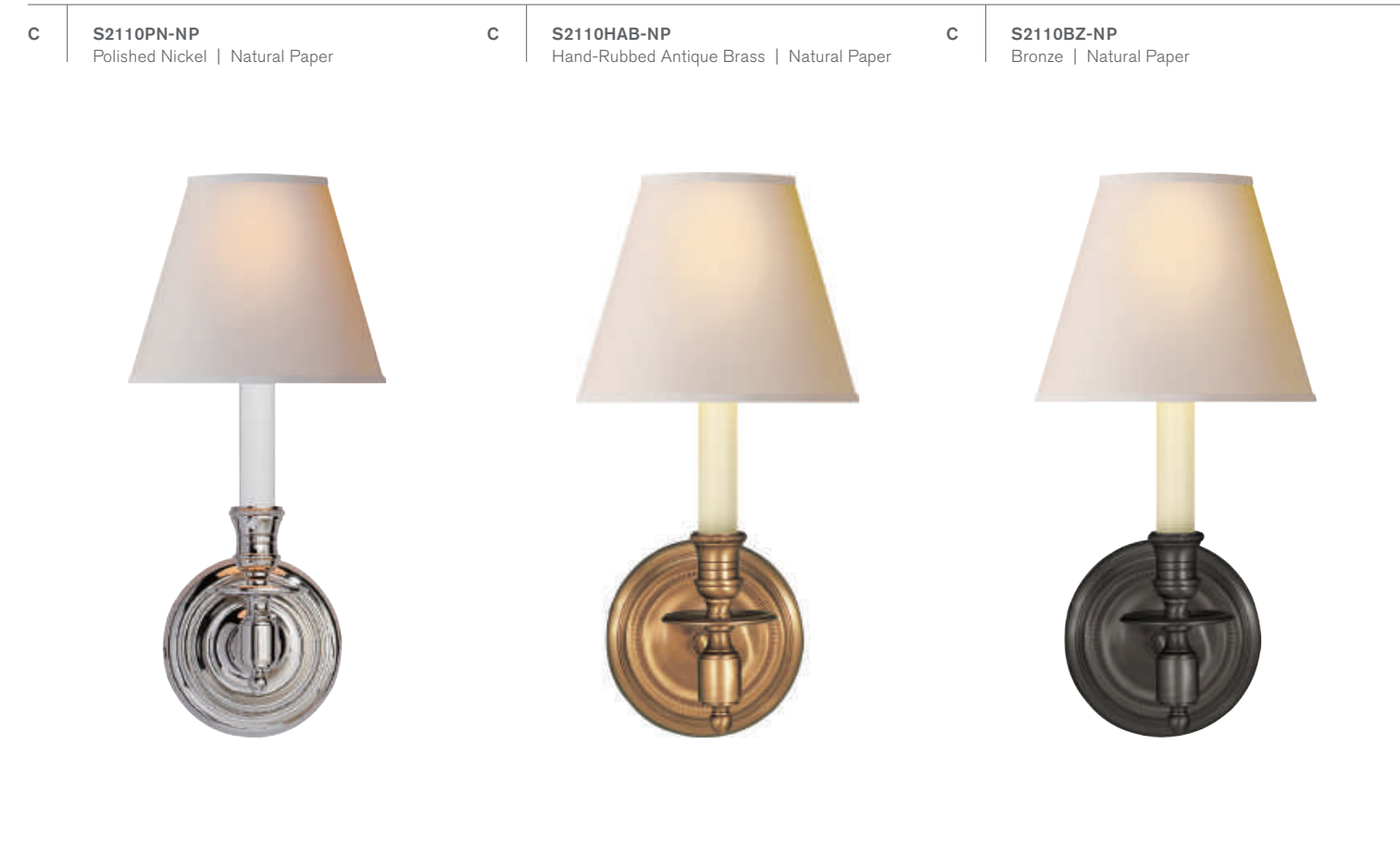

**C** **FRENCH SINGLE SCONCE**  
STUDIO VC

**S2110**  
H: 12" | W: 6" | Ext: 10"  
Backplate: 4.5" Round  
Socket: E12 Candelabra | Bulb: 40 B  
Shade: 3" x 6" x 5"

**Additional Options for French Sconce:**  
Antique Nickel (AN)  
Bronze (BZ)  
Hand-Rubbed Antique Brass (HAB)  
Polished Nickel (PN)  
Linen (L)  
Natural Paper (NP)  
Tissue (T)

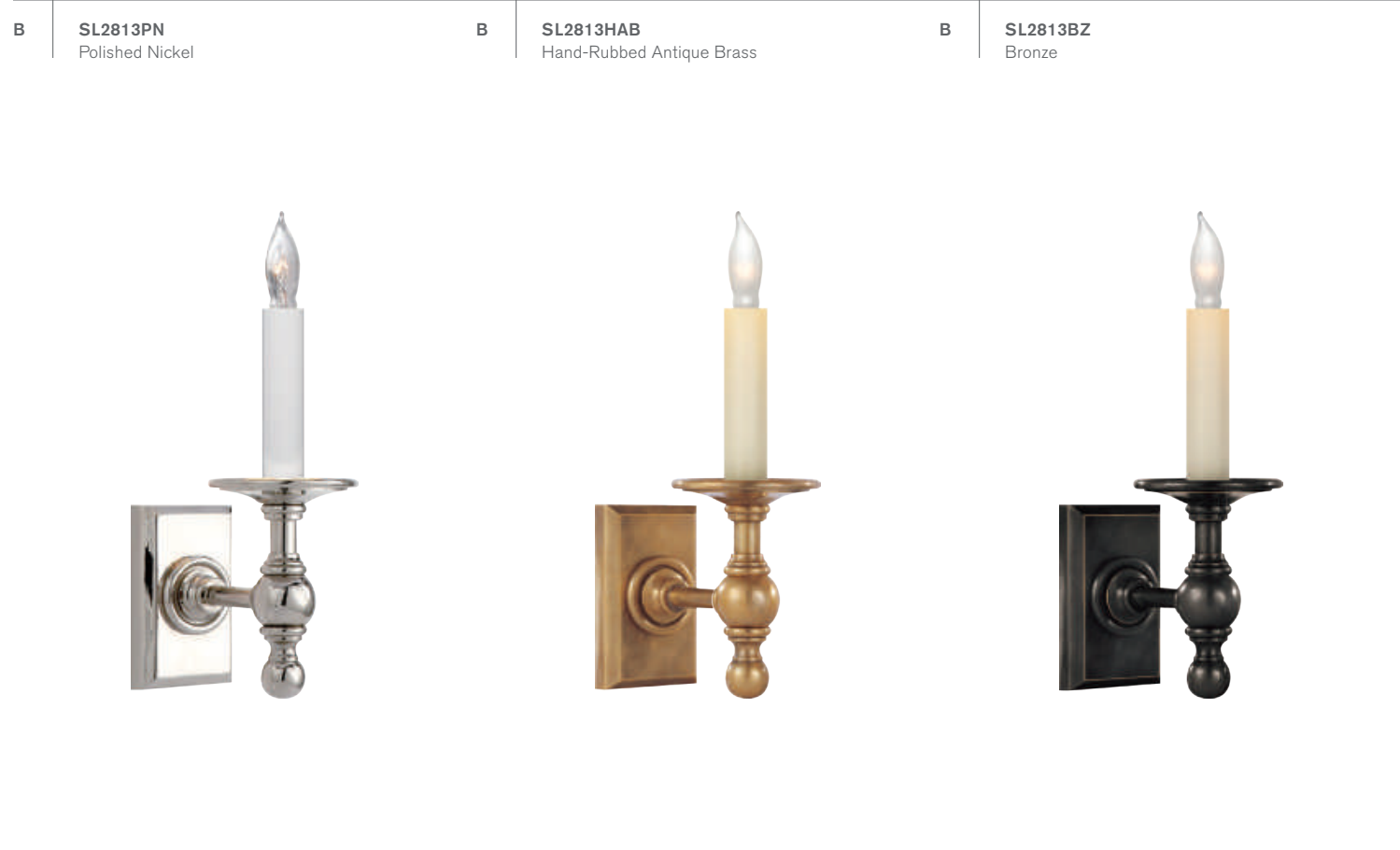

**B** **SINGLE LIBRARY CLASSIC SCONCE**  
E. F. CHAPMAN

**SL2813**  
H: 8" | W: 3.5" | Ext: 6"  
Backplate: 2.75" x 4.5" Rec.  
Socket: E12 Candelabra | Bulb: 60 C  
**Additional Options:**  
Antique Nickel (AN)  
\* Requires Smaller Outlet Box  
\* CHS104NP Shade Sold Separately  
\* Use 40 Bulb Frosted Type "B" with Clip On Shade  
©EFC DESIGNS

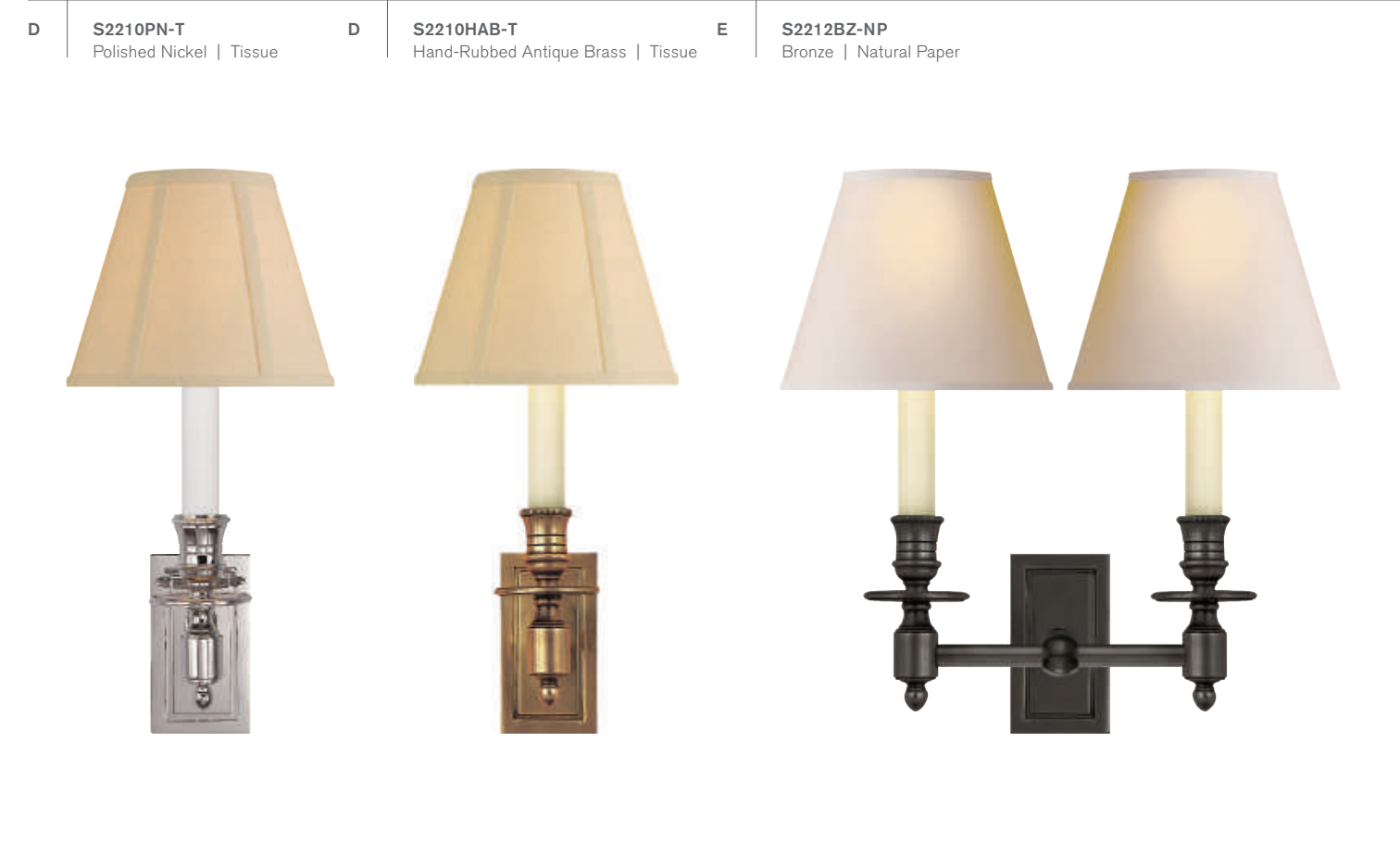

**D** **FRENCH SINGLE LIBRARY SCONCE**  
STUDIO VC

**S2210**  
H: 12" | W: 6" | Ext: 6.75"  
Backplate: 2.5" x 4.5" Rec.  
Socket: E12 Candelabra | Bulb: 40 B  
Shade: 3" x 6" x 5"  
\* Requires Smaller Outlet Box

**E** **FRENCH DOUBLE LIBRARY SCONCE**  
IAN K. FOWLER

**S2212**  
H: 12" | W: 12" | Ext: 8.75"  
Backplate: 2.5" x 4.5" Rec.  
Socket: 2 - E12 Candelabra | Bulb: 2 - 40 B  
Shade: 3" x 5" x 4"  
\* Requires Smaller Outlet Box

**Additional Options for French Library Sconce:**  
Antique Nickel (AN)  
Bronze (BZ)  
Hand-Rubbed Antique Brass (HAB)  
Polished Nickel (PN)  
Linen (L)  
Natural Paper (NP)  
Tissue (T)

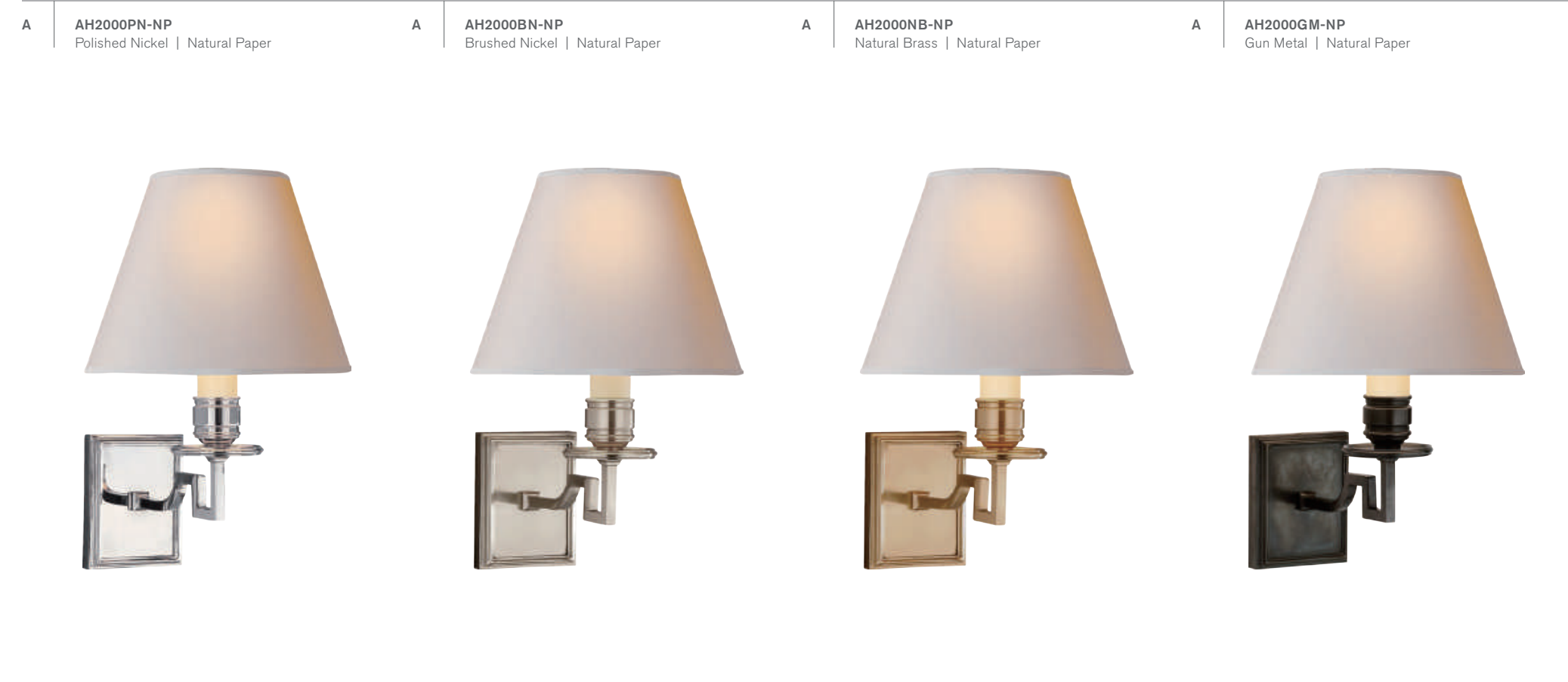

opposite page

**A DEAN SINGLE ARM SCONCE**  
ALEXA HAMPTON

**AH2000**  
H: 12.75" | W: 8.25" | Ext: 10.25"  
Backplate: 3.5" x 4.5" Rec.  
Socket: E26 Keyless | Bulb: 60 A  
Shade: 4.25" x 8.25" x 6.5"  
\* Requires Smaller Outlet Box

**B DEAN LIBRARY SCONCE**  
ALEXA HAMPTON

**AH2001**  
H: 13" | W: 6.5" | Ext: 7"  
Backplate: 2.75" x 4.5" Rec.  
Socket: E12 Candelabra | Bulb: 40 B  
Shade: 3" x 6.5" x 5"  
\* Requires Smaller Outlet Box

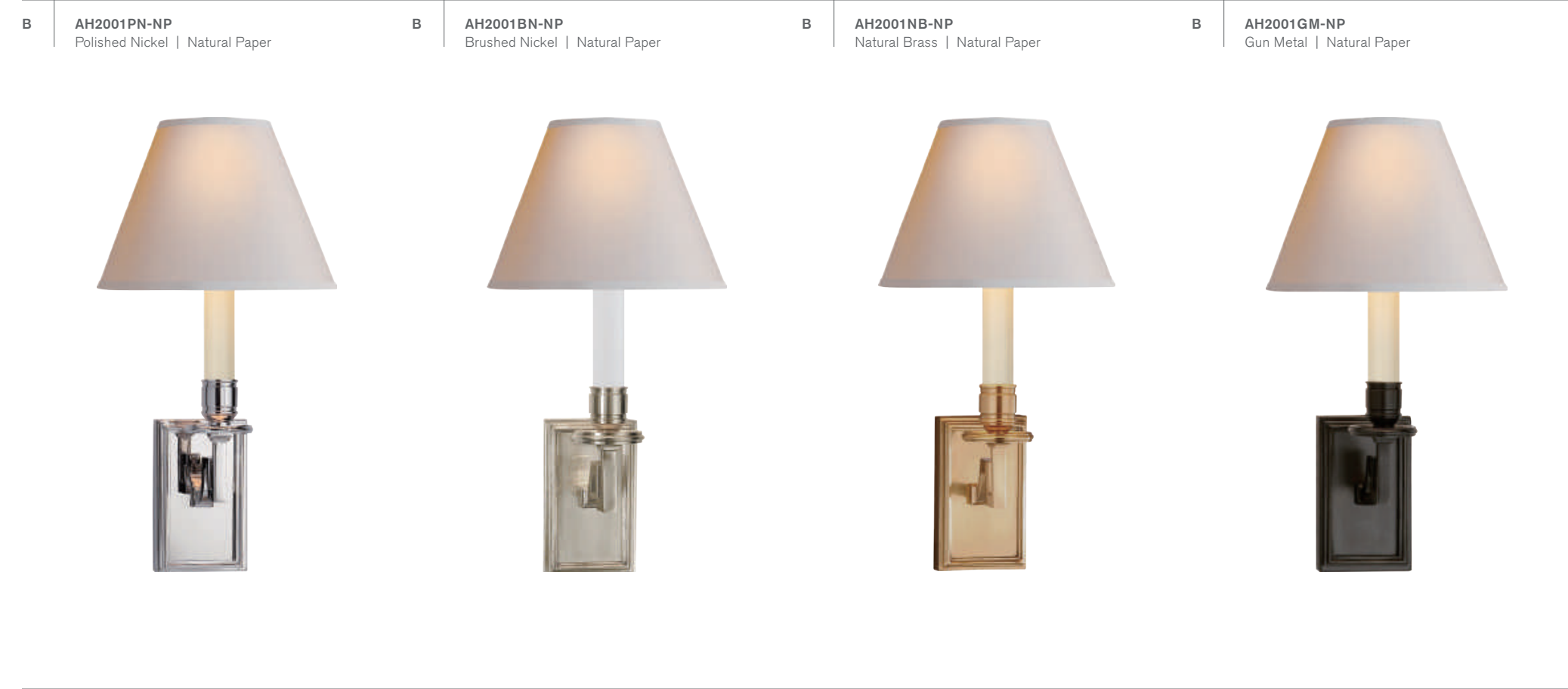

**C JANE WALL SCONCE**  
ALEXA HAMPTON

**AH2305**  
H: 13.5" | W: 7" | Ext: 8.5"  
Backplate: 3.25" x 4.75" Rec.  
Socket: E26 Keyless | Bulb: 60 A  
Shade: 3.5" x 7" x 6"  
**Additional Options:**  
Antique Nickel | Natural Paper (AN-NP)  
\* Requires Smaller Outlet Box

**D GINGER SINGLE ARM SCONCE**  
ALEXA HAMPTON

**AH2010**  
H: 15.5" | W: 8.25" | Ext: 10"  
Backplate: 2.75" x 10.75" Rec.  
Socket: E26 Keyless | Bulb: 60 A  
Shade: 4.25" x 8.25" x 6.5"  
\* Requires Smaller Outlet Box

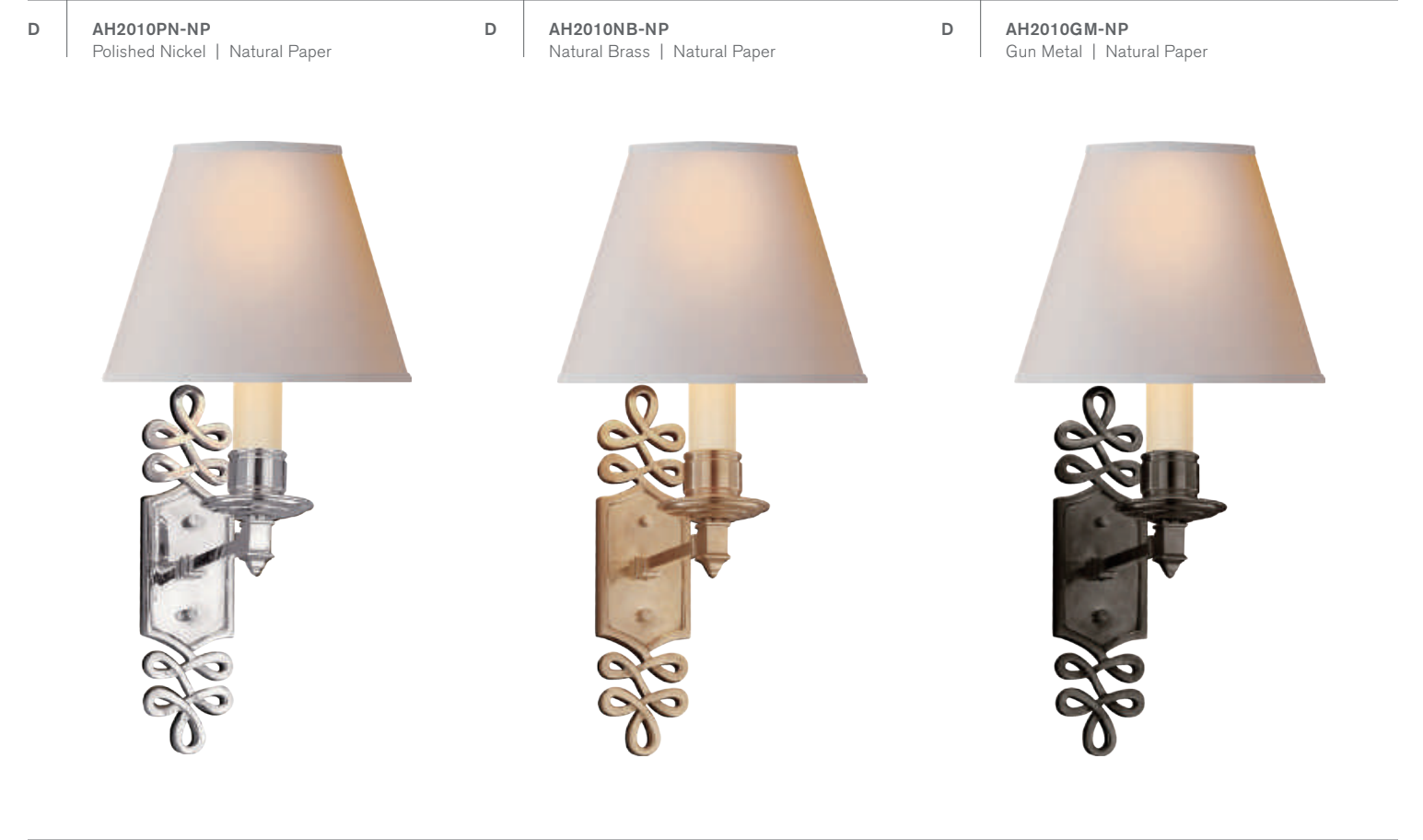
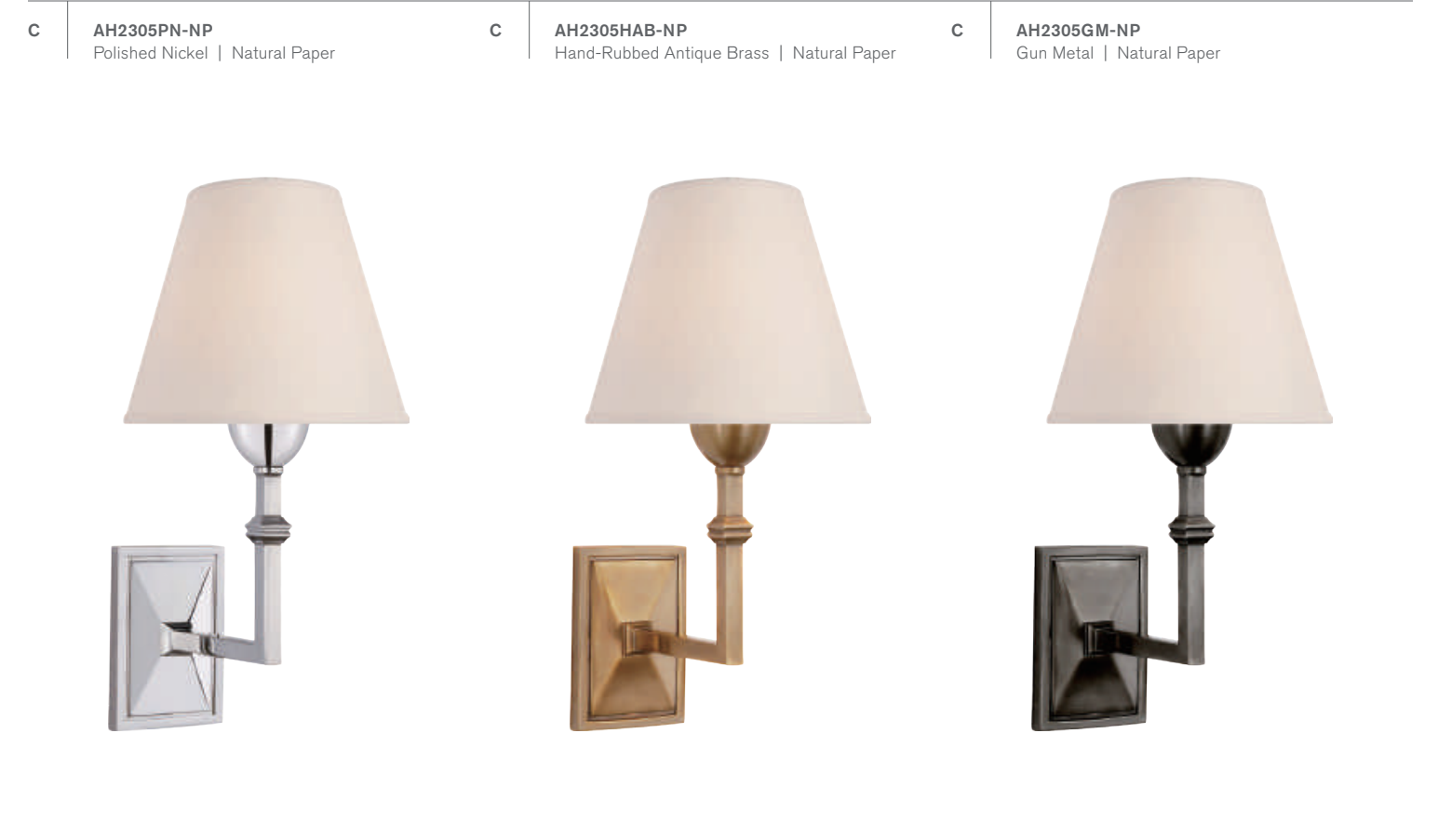

A

**S2017PN**  
Polished Nickel | Clear Glass



A

**S2017AI**  
Aged Iron | Clear Glass



B

**S2015PN**  
Polished Nickel | Clear Glass



B

**S2015AI**  
Aged Iron | Clear Glass



A

**BELDEN ROUND SCONCE**  
IAN K. FOWLER

**S2017**  
H: 20" | W: 4.5" | Ext: 6"  
Backplate: 4.5" x 20" Rec.  
Socket: E26 Keyless | Bulb: 60 T

B

**BELDEN SQUARE SCONCE**  
IAN K. FOWLER

**S2015**  
H: 19.75" | W: 4.5" | Ext: 6.5"  
Backplate: 4.5" x 19.75" Rec.  
Socket: E26 Keyless | Bulb: 60 T

C

**CHD2933AI-CG**  
Aged Iron | Clear Glass



D

**CHD2930AI-CG**  
Aged Iron | Clear Glass



E

**CHD2935AI-CG**  
Aged Iron | Clear Glass



opposite page

C

**FRESNO MEDIUM FRAMED SCONCE**  
E. F. CHAPMAN

**CHD2933**  
H: 17.75" | W: 6" | Ext: 9"  
Backplate: 4.25" x 8" Rec.  
Socket: E26 Keyless | Bulb: 60 T

D

**FRESNO SMALL FRAMED SCONCE**  
E. F. CHAPMAN

**CHD2930**  
H: 10.5" | W: 5" | Ext: 8"  
Backplate: 4.25" x 6" Rec.  
Socket: E26 Keyless | Bulb: 60 A

E

**FRESNO LARGE FRAMED SCONCE**  
E. F. CHAPMAN

**CHD2935**  
H: 21.75" | W: 6" | Ext: 9"  
Backplate: 4.25" x 12" Rec.  
Socket: E26 Keyless | Bulb: 60 T  
©EFC DESIGNS

B CHD2908BZ  
Bronze | Clear Glass



**A LINEAR MINI WALL LANTERN**  
E. F. CHAPMAN

**CHD2907**  
H: 12" | W: 5" | Ext: 5"  
Backplate: 4.75" x 7.75" Rec.  
Socket: 2 - E12 Candelabra | Bulb: 2 - 40 C  
**Additional Options:**  
Antique-Burnished Brass | Clear Glass (AB-CG)  
Bronze (BZ-CG)  
Weathered Zinc | Clear Glass (WZ-CG)  
©EFC DESIGNS

**B LINEAR LANTERN SHORT**  
E. F. CHAPMAN

**CHD2908**  
H: 15" | W: 9" | Ext: 5"  
Backplate: 9" x 13" Rec.  
Socket: 2 - E12 Candelabra | Bulb: 2 - 60 C  
**Additional Options:**  
Antique Nickel | Clear Glass (AN)  
Polished Nickel | Clear Glass (PN)  
Weathered Zinc | Clear Glass (WZ)  
©EFC DESIGNS

**C LINEAR LANTERN TALL**  
E. F. CHAPMAN

**CHD2910**  
H: 22.5" | W: 9" | Ext: 5"  
Backplate: 9" x 20" Rec.  
Socket: 2 - E12 Candelabra | Bulb: 2 - 60 C  
**Additional Options:**  
Antique-Burnished Brass | Clear Glass (AB)  
Bronze (BZ)  
Weathered Zinc | Clear Glass (WZ)  
©EFC DESIGNS

**D LINEAR LARGE WALL LANTERN**  
E. F. CHAPMAN

**CHD2911**  
H: 29" | W: 9" | Ext: 5"  
Backplate: 8.5" x 19.75" Rec.  
Socket: 2 - E12 Candelabra | Bulb: 2 - 60 C  
**Additional Options:**  
Antique Nickel | Clear Glass (AN-CG)  
Polished Nickel | Clear Glass (PN-CG)  
Weathered Zinc | Clear Glass (WZ-CG)  
©EFC DESIGNS

A CHD2907PN-CG  
Polished Nickel



A CHD2907AN-CG  
Antique Nickel



B CHD2908AB  
Antique-Burnished Brass | Clear Glass



B CHD2908BZ  
Bronze | Clear Glass



C CHD2910PN  
Polished Nickel | Clear Glass



C CHD2910AN  
Antique Nickel | Clear Glass



D CHD2911AB-CG  
Antique-Burnished Brass | Clear Glass



D CHD2911BZ-CG  
Bronze | Clear Glass





**A** **DARLANA WALL LANTERN**  
E. F. CHAPMAN

**CHD2165**  
H: 17" | W: 11" | Ext: 8.5"  
Backplate: 10" x 11.5" Rec.  
Socket: E12 Candelabra | Bulb: 60 C  
©EFC DESIGNS

**B** **FLEA MARKET LANTERN**  
SUZANNE KASLER

**SK2301**  
H: 18" | W: 11.5" | Ext: 7"  
Backplate: 10" x 12.25" Rec.  
Socket: E12 Candelabra | Bulb: 60 C

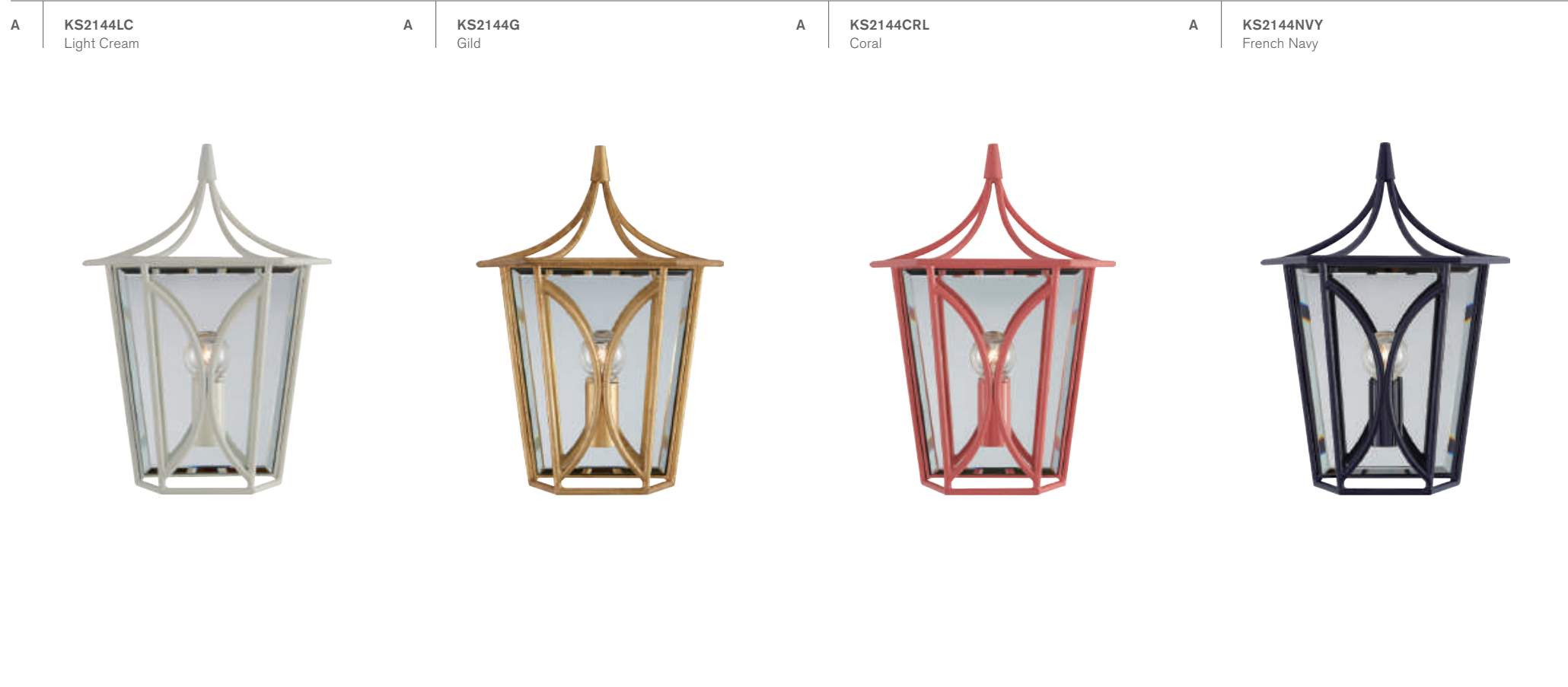

opposite page

**A CAVANAGH MINI LANTERN SCONCE**  
KATE SPADE NEW YORK

**KS2144**  
H: 12" | W: 8.5" | Ext: 4.5"  
Backplate: 6.5" x 7.5" Rec.  
Socket: E12 Candelabra | Bulb: 40 G  
**Additional Options:**  
Polished Nickel (PN)

**B CAVANAGH MEDIUM LANTERN SCONCE**  
KATE SPADE NEW YORK

**KS2143**  
H: 17" | W: 12" | Backplate: 9" x 10.5" Rec.  
Socket: 2 - E12 Candelabra | Bulb: 2 - 40 G  
**Additional Options:**  
Light Cream (LC)

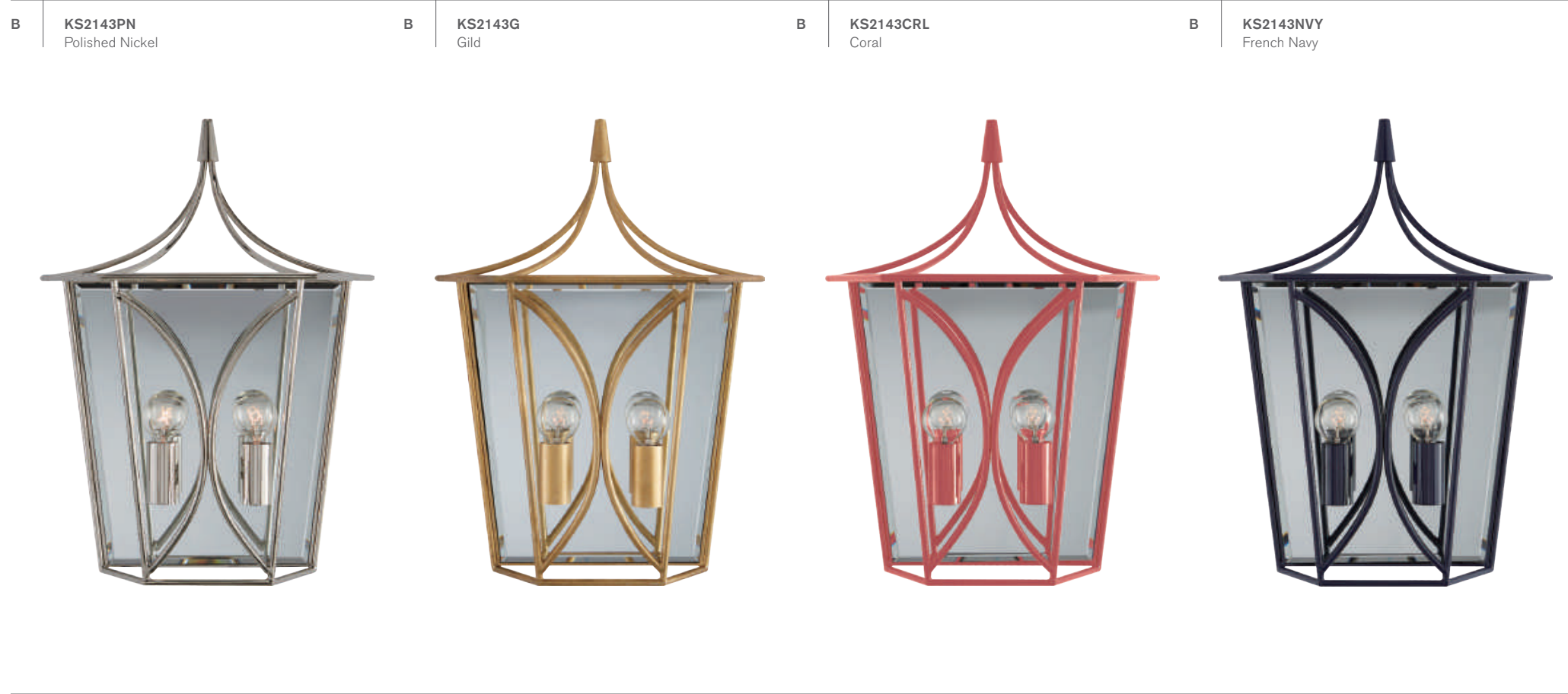
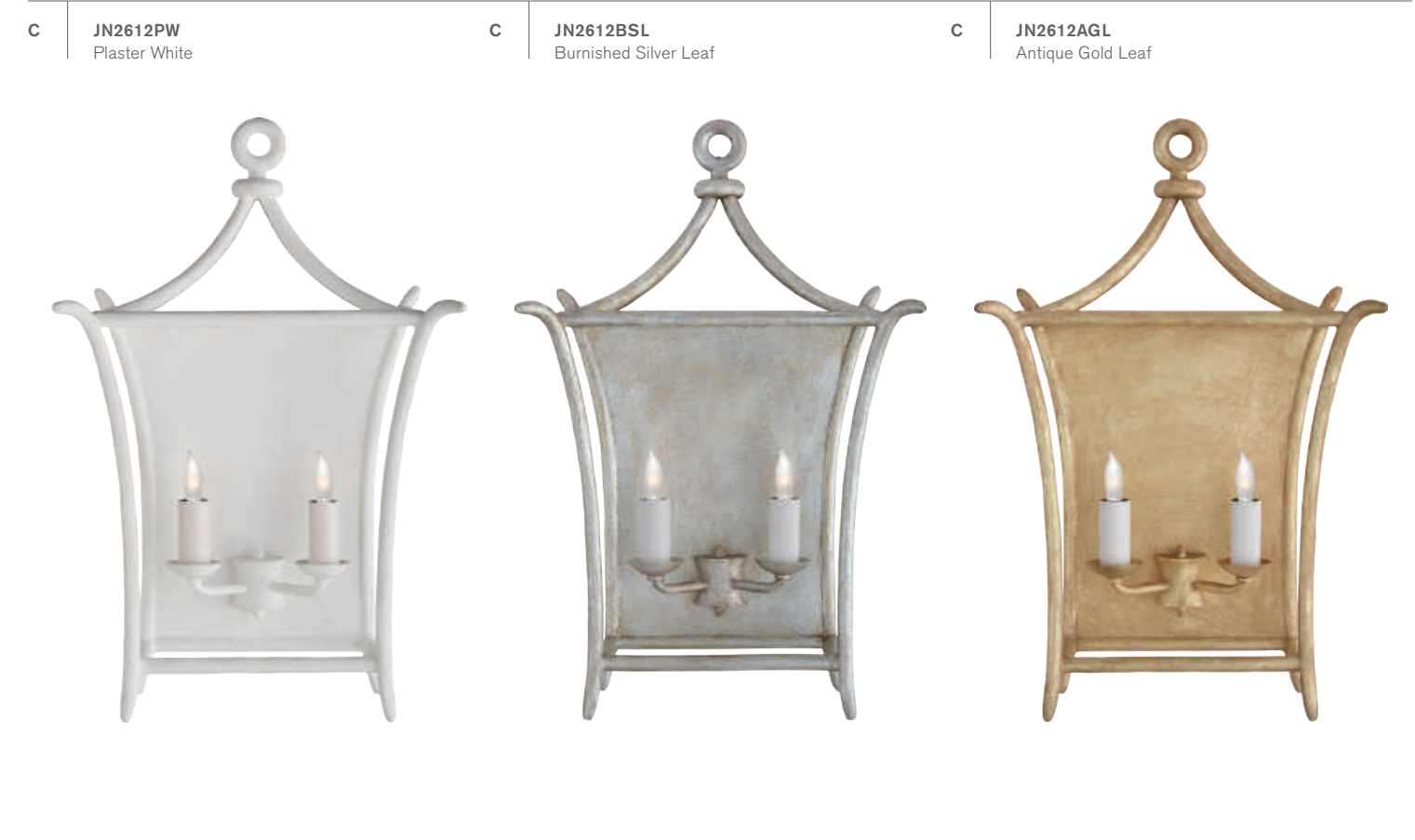

**C ARIA LARGE WALL LANTERN**  
JULIE NEILL

**JN2612**  
H: 22" | W: 14" | Ext: 7"  
Backplate: 10" x 13" Rec.  
Socket: 2 - E12 Candelabra | Bulb: 2 - 40 C

**D CADDO LANTERN SCONCE**  
JULIE NEILL

**JN2020**  
H: 16.5" | W: 16" | Ext: 8.5"  
Backplate: 13" Square  
Socket: 2 - E12 Candelabra | Bulb: 2 - 60 C  
**Additional Options:**  
Celadon | Gild | Clear Glass (CEL/G-CG)

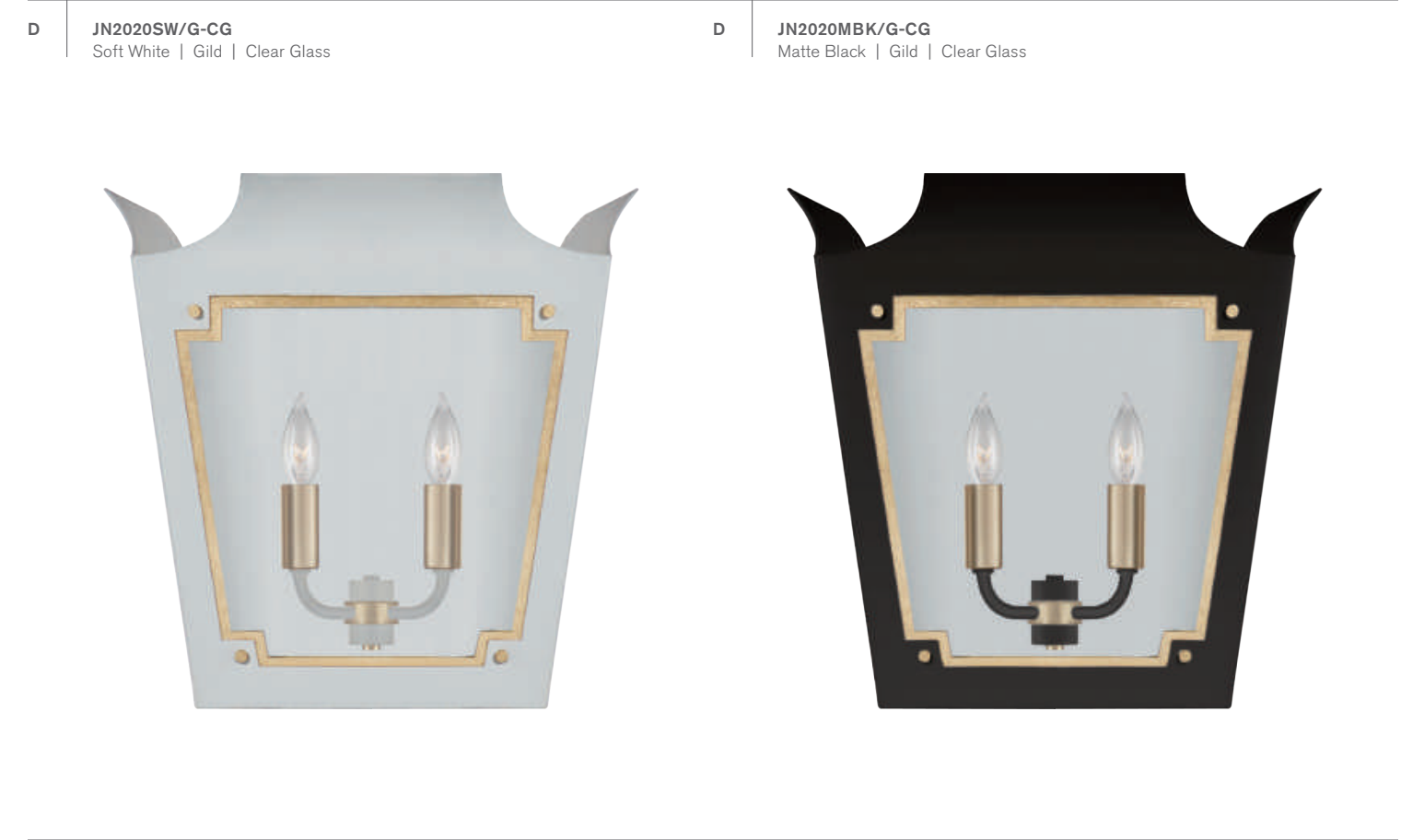

A

**ARN2009PN/WHT**  
Polished Nickel | White



A

**ARN2009PN/BLK**  
Polished Nickel | Black



A

**CLARKSON MEDIUM NARROW SCONCE**  
AERIN

**ARN2009**  
H: 17.75" | W: 4.5" | Ext: 5.75"  
Backplate: 4.5" Round  
Socket: 2 - E12 Candelabra | Bulb: 2 - 25 B  
Shade: 7" x 7.5" x 6.5"  
**Additional Options:**  
Polished Nickel (PN/PN)

B

**ARN2008PN-L**  
Polished Nickel | Linen



C

**BBL2110PN-S**  
Polished Nickel | Silk



C

**BBL2110SB-S**  
Soft Brass | Silk



C

**FRAMEWORK SCONCE**  
BARBARA BARRY

**BBL2110**  
H: 12.75" | W: 5.25" | Ext: 7"  
Backplate: 3.75" Square  
Socket: E26 Keyless | Bulb: 40 B  
Shade: 5.25" x 5.25" x 10"  
\* Requires Smaller Outlet Box

D

**S2323PN-L**  
Polished Nickel | Linen



A

**ARN2009HAB/WHT**  
Hand-Rubbed Antique Brass | White



A

**ARN2009HAB/BLK**  
Hand-Rubbed Antique Brass | Black



B

**ARN2008HAB-L**  
Hand-Rubbed Antique Brass | Linen



C

**BBL2110SS-S**  
Soft Silver | Silk



C

**BBL2110BZ-S**  
Bronze | Silk



D

**S2323AI-L**  
Aged Iron | Linen



B

**CLARKSON SMALL SINGLE PIVOTING SCONCE**  
AERIN

**ARN2008**  
H: 11.5" | W: 7" | Ext: 8.25"  
Backplate: 4.5" Round  
Socket: E12 Candelabra | Bulb: 40 B  
Shade: 3.75" x 6.75" x 7.5"

D

**MILO SMALL SCONCE**  
IAN K. FOWLER

**S2323**  
H: 11" | W: 7" | Ext: 4.25"  
Backplate: 4" x 9" Rec.  
Socket: E12 Candelabra | Bulb: 25 B

**A** | **BOWERY 18" WALL SCONCE**  
CLODAGH

**CL2181**  
H: 18" | W: 3.5" | Ext: 3.75"  
Backplate: 3.5" x 18" Rec.  
Socket: 2 - E26 Keyless | Bulb: 2 - 40 T

**A** | **CL2181PN**  
Polished Nickel | Mesh



**A** | **CL2181AI**  
Aged Iron | Mesh



**B** | **PRIMITIVE WRAPPED SCONCE**  
CLODAGH

**CL2016**  
H: 10.5" | W: 5" | Ext: 3.5"  
Backplate: 4.5" x 10.75" Rec.  
Socket: E26 Keyless | Bulb: 60 B

**C** | **TOURAIN WALL SCONCE**  
AERIN

**ARN2045**  
H: 13" | W: 4.25" | Ext: 4.5"  
Backplate: 4.25" x 6" Rec.  
Socket: E26 Keyless | Bulb: 40 T

**B** | **CL2016PN-FG**  
Polished Nickel | Frosted Glass



**B** | **CL2016BS-FG**  
Brushed Steel | Frosted Glass



**B** | **CL2016BZ-FG**  
Bronze | Frosted Glass



**C** | **ARN2045PW/G**  
Plaster White | Gild Interior



**C** | **ARN2045BSL**  
Burnished Silver Leaf | Plaster White Interior



**C** | **ARN2045G**  
Gild | Plaster White Interior



**C** | **ARN2045BLK/G**  
Black | Gild Interior





**A SELFLOSS SMALL SCONCE**  
AERIN

**ARN2036**  
H: 11" | W: 7" | Ext: 4.25"  
Backplate: 4.5" x 6.25" Rec.  
Socket: 2 - E12 Candelabra | Bulb: 2 - 25 C



**A ARN2036PW**  
Plaster White | Gild Interior

**A ARN2036BLK**  
Black | Brass Interior

**A ARN2036BZ**  
Bronze | Gild Interior

**C ARN2065PN**  
Polished Nickel

**C ARN2065HAB**  
Hand-Rubbed Antique Brass

**C ARN2065BZ**  
Bronze

**C IVA MEDIUM WRAPPED SCONCE**  
AERIN

**ARN2065**  
H: 17.25" | W: 7" | Ext: 4.25"  
Backplate: 4.25" x 6.5" Rec.  
Socket: 2 - E12 Candelabra | Bulb: 2 - 40 T



**B SELFLOSS LARGE SCONCE**  
AERIN

**ARN2037**  
H: 23" | W: 8" | Ext: 4.75"  
Backplate: 4.75" x 18" Rec.  
Socket: 4 - E12 Candelabra | Bulb: 4 - 40 T  
Shade: 6.5" x 7.25" x 8.75"



**B ARN2037PW/G**  
Plaster White | Gild

**B ARN2037BLK/HAB**  
Black | Hand-Rubbed Antique Brass

**B ARN2037BZ/G**  
Bronze | Gild

**D ARN2066PN**  
Polished Nickel

**D ARN2066HAB**  
Hand-Rubbed Antique Brass

**D ARN2066BZ**  
Bronze

**D IVA LARGE WRAPPED SCONCE**  
AERIN

**ARN2066**  
H: 24" | W: 6.25" | Ext: 5.75"  
Backplate: 4.25" x 16.25" Rec.  
Socket: 3 - E12 Candelabra | Bulb: 3 - 40 T



A **KW2063PN**  
Polished Nickel

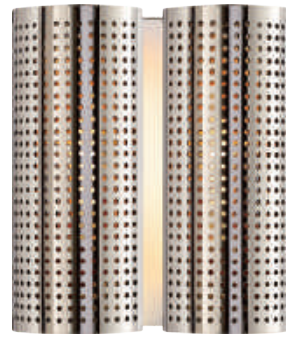

A **KW2063AB**  
Antique-Burnished Brass

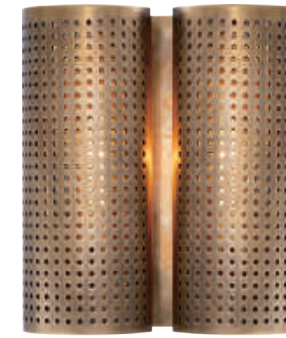

A **KW2063BZ**  
Bronze

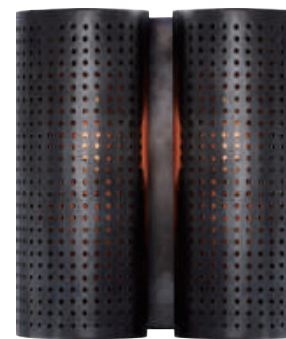

B **KW2060AB**  
Antique-Burnished Brass



opposite page

A **PRECISION MEDIUM SCONCE**  
KELLY WEARSTLER

**KW2063**  
H: 8.75" | W: 8" | Ext: 4"  
Backplate: 4.25" x 7" Rec.  
Socket: 2 - E17 Keyless | Bulb: 2 - 40 T

B **PRECISION SMALL SCONCE**  
KELLY WEARSTLER

**KW2060**  
H: 7.75" | W: 8.75" | Ext: 3.25"  
Backplate: 5.5" Square  
Socket: E17 Keyless | Bulb: 40 T  
**Additional Options:**  
Bronze (BZ)  
Polished Nickel (PN)

C **ESKER SMALL TRIANGLE SCONCE**  
KELLY WEARSTLER

**KW2709**  
H: 10" | W: 6" | Ext: 3"  
Backplate: 5.5" x 9.5" Rec.  
LED: 11w

D **ESKER ENVELOPE SCONCE**  
KELLY WEARSTLER

**KW2706**  
H: 7" | W: 9" | Ext: 1.5"  
Backplate: 7" x 9" Rec.  
LED: 12w

E **ESKER SINGLE FOLD SCONCE**  
KELLY WEARSTLER

**KW2707**  
H: 9.75" | W: 9" | Ext: 3.25"  
Backplate: 9" x 9.75" Rec.  
LED: 12w

C **KW2709PN**  
Polished Nickel



C **KW2709AB**  
Antique-Burnished Brass

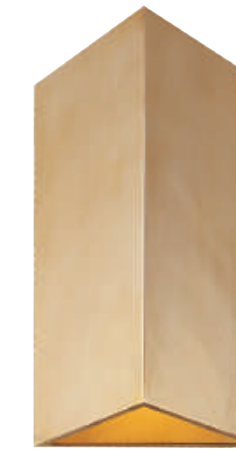

C **KW2709BZ**  
Bronze



D **KW2706PN**  
Polished Nickel



D **KW2706AB**  
Antique-Burnished Brass



D **KW2706BZ**  
Bronze



E **KW2707PN**  
Polished Nickel



E **KW2707AB**  
Antique-Burnished Brass



E **KW2707BZ**  
Bronze



**A** **KW2704AB-FG**  
Antique-Burnished Brass | Frosted Glass



**A** **KW2704BZ-FG**  
Bronze | Frosted Glass



**A** **AVANT SMALL CURVE SCONCE**  
KELLY WEARSTLER

**KW2704**  
H: 11.5" | W: 7" | Ext: 2.25"  
Backplate: 7" x 11.5" Rec.  
LED: 6w  
**Additional Options:**  
Polished Nickel | Frosted Glass (PN-FG)

**B** **AVANT MEDIUM LINEAR SCONCE**  
KELLY WEARSTLER

**KW2702**  
H: 22" | W: 4.25" | Ext: 4.25"  
Backplate: 4.25" x 22" Rec.  
Socket: 2 - E12 Candelabra | Bulb: 2 - 60 B  
**Additional Options:**  
Polished Nickel | Frosted Glass (PN-FG)

**C** **KW2705AB-FG**  
Antique-Burnished Brass | Frosted Glass



**C** **KW2705BZ-FG**  
Bronze | Frosted Glass



**D** **IRVING WALL WASHER**  
AERIN

**ARN2020**  
H: 6.5" | W: 12.5" | Ext: 6.5"  
Backplate: 4" x 4" Square  
Socket: E26 Keyless | Bulb: 60 B

**D** **ARN2020PN**  
Polished Nickel



**D** **ARN2020HAB**  
Hand-Rubbed Antique Brass



**D** **ARN2020BZ**  
Bronze



**B** **KW2702AB-FG**  
Antique-Burnished Brass | Frosted Glass



**B** **KW2702BZ-FG**  
Bronze | Frosted Glass



**C** **AVANT LARGE CURVED SCONCE**  
KELLY WEARSTLER

**KW2705**  
H: 24.5" | W: 6.25" | Ext: 4.25"  
Backplate: 4" x 3" Decorative  
Socket: 2 - E17 Keyless | Bulb: 2 - 40 T

**E** **ALINA TAIL SCONCE**  
AERIN

**ARN2260**  
H: 20" | W: 9" | Ext: 8.5"  
Backplate: 7" x 7" Trapezoid  
Socket: E12 Candelabra | Bulb: 60 C

**E** **ARN2260PN**  
Polished Nickel



**E** **ARN2260HAB**  
Hand-Rubbed Antique Brass



**E** **ARN2260BZ**  
Bronze





**A** | **ARN2307BSL**  
Burnished Silver Leaf

**A** | **ARN2307G**  
Gild

**A** | **ARABELLE SMALL SCONCE**  
AERIN  
**ARN2307**  
H: 10" | W: 5.5" | Ext: 3.75"  
Backplate: 2.5" x 7" Rec.  
Socket: 2 - E12 Candelabra | Bulb: 2 - 25 B  
\* Requires Smaller Outlet Box

**B** | **ARABELLE MEDIUM SCONCE**  
AERIN  
**ARN2306**  
H: 14" | W: 7.75" | Ext: 5"  
Backplate: 4.25" x 6.25" Rec.  
Socket: 2 - E12 Candelabra | Bulb: 2 - 40 B

**C** | **KW2250AB-WG**  
Antique-Burnished Brass | White Glass



**D** | **KW2091AB/Q**  
Antique-Burnished Brass | Quartz



**D** | **HALCYON RECTANGLE SCONCE**  
KELLY WEARSTLER  
**KW2091**  
H: 14" | W: 6.25" | Ext: 4.5"  
Backplate: 4.5" Round  
Socket: E12 Candelabra | Bulb: 60 B

**E** | **HALCYON ROUND SCONCE**  
KELLY WEARSTLER  
**KW2090**  
H: 14" | W: 14" | Ext: 4.75"  
Backplate: 9.5" Round  
Socket: 2 - E12 Candelabra | Bulb: 2 - 60 B



**B** | **ARN2306BSL**  
Burnished Silver Leaf

**B** | **ARN2306G**  
Gild

**C** | **KW2250BZ-WG**  
Bronze | White Glass



**C** | **FORMA SCONCE**  
KELLY WEARSTLER  
**KW2250**  
H: 15" | W: 6.5" | Ext: 3.75"  
Backplate: 5.75" x 14" Rec.  
Socket: E12 Candelabra | Bulb: 60 C

**E** | **KW2090AB/Q**  
Antique-Burnished Brass | Quartz



**A** | **KW2901TVT**  
Travertine



**B** | **KW2900TVT**  
Travertine



**C** | **ARN2039HAB-ALB**  
Hand-Rubbed Antique Brass | Alabaster



**A** | **TRIBUTE TALL SCONCE**  
KELLY WEARSTLER

**KW2901**  
H: 18" | W: 5" | Ext: 4"  
Backplate: 4" x 17" Rec.  
LED: 8w

**B** | **TRIBUTE MEDIUM SCONCE**  
KELLY WEARSTLER

**KW2900**  
H: 15" | W: 12" | Ext: 4"  
Backplate: 11" x 14" Rec.  
LED: 12w

opposite page

**C** | **IVEALA SINGLE SCONCE**  
AERIN

**ARN2039**  
H: 12.75" | W: 10.5" | Ext: 4.25"  
Backplate: 4.5" Round  
Socket: E12 Candelabra | Bulb: 40 C

**D** | **CLAYTON WALL SCONCE**  
AERIN

**ARN2043**  
H: 12.5" | W: 5.25" | Ext: 3.75"  
Backplate: 4.75" x 12.25" Rec.  
Socket: 2 - E12 Candelabra | Bulb: 2 - 12 LED B

**E** | **HENSON SINGLE SCONCE**  
AERIN

**ARN2910**  
H: 13.5" | W: 8.5" | Ext: 4.25"  
Backplate: 4.5" Square  
Socket: E12 Candelabra | Bulb: 25 B

**F** | **DOMINICA RECTANGLE SCONCE**  
AERIN

**ARN2920**  
H: 19.5" | W: 9" | Ext: 3.25"  
Backplate: 5" x 10" Rec.  
Socket: E12 Candelabra | Bulb: 6.5 LED B  
\* Alabaster is a Natural Stone  
\* Variations in Color and Texture are Expected

**C** | **ARN2039PN-ALB**  
Polished Nickel | Alabaster



**C** | **ARN2039HAB-ALB**  
Hand-Rubbed Antique Brass | Alabaster



**D** | **ARN2043CG**  
Crystal | Brass



**D** | **ARN2043ALB**  
Alabaster | Brass

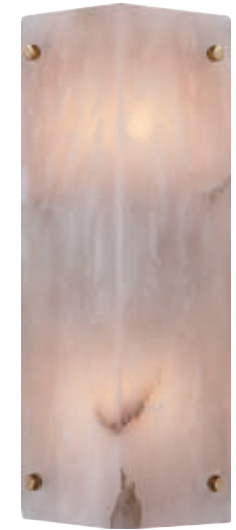

**E** | **ARN2910PN-ALB**  
Polished Nickel | Alabaster



**E** | **ARN2910HAB-ALB**  
Hand-Rubbed Antique Brass | Alabaster

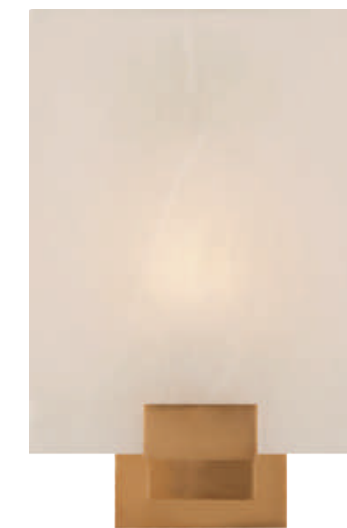

**F** | **ARN2920BSL/ALB**  
Burnished Silver Leaf | Alabaster



**F** | **ARN2920G/ALB**  
Gild | Alabaster

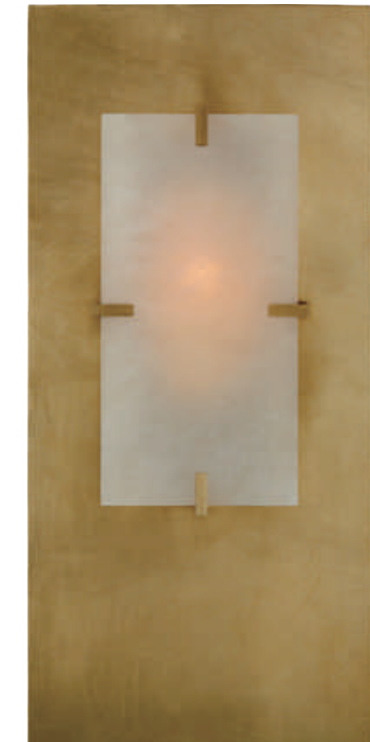

**A** **KW2012AB-ALB**  
Antique-Burnished Brass | Alabaster



**A** **KW2012BZ-ALB**  
Bronze | Alabaster



**A** **MELANGE PILL FORM SCONCE**  
KELLY WEARSTLER  
  
**KW2012**  
H: 12.5" | W: 4.25" | Ext: 4"  
Backplate: 4.25" Round  
Socket: 2 - E12 Candelabra | Bulb: 2 - 12 LED B  
**Additional Options:**  
Polished Nickel | Alabaster (PN-ALB)

**B** **MELANGE ELONGATED SCONCE**  
KELLY WEARSTLER  
  
**KW2013**  
H: 20" | W: 4.25" | Ext: 3.5"  
Backplate: 4.25" x 20" Rec.  
Socket: 2 - E26 Keyless | Bulb: 2 - 12 LED B  
**Additional Options:**  
Polished Nickel | Alabaster (PN-ALB)

**C** **KW2010AB-ALB**  
Antique-Burnished Brass | Alabaster



**D** **MELANGE FLOATING DISC SCONCE**  
KELLY WEARSTLER  
  
**KW2610**  
H: 10.75" | W: 5.25" | Ext: 6.75"  
Backplate: 4.5" x 8" Rec.  
LED: 4w

**D** **KW2610PN-ALB**  
Polished Nickel | Alabaster



**D** **KW2610AB-ALB**  
Antique-Burnished Brass | Alabaster



**D** **KW2610BZ-ALB**  
Bronze | Alabaster



**B** **KW2013AB-ALB**  
Antique-Burnished Brass | Alabaster



**B** **KW2013BZ-ALB**  
Bronze | Alabaster



**C** **MELANGE SCONCE**  
KELLY WEARSTLER  
  
**KW2010**  
H: 7" | W: 7" | Ext: 3.25"  
Backplate: 4" Round  
Socket: E12 Candelabra | Bulb: 9 LED B  
**Additional Options:**  
Polished Nickel | Alabaster (PN-ALB)

**C** **KW2010BZ-ALB**  
Bronze | Alabaster

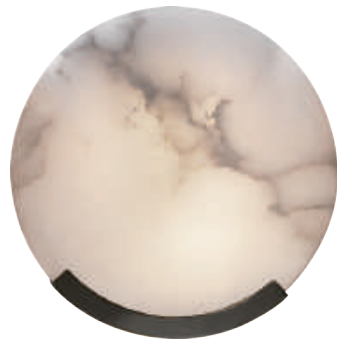

**E** **MELANGE MEDIUM ELONGATED PILL SCONCE**  
KELLY WEARSTLER  
  
**KW2014**  
H: 18.5" | W: 4" | Ext: 3.25"  
Backplate: 4" x 18.25" Oval  
Socket: E12 Candelabra | Bulb: 6w LED B

**E** **KW2014PN-ALB**  
Polished Nickel | Alabaster



**E** **KW2014AB-ALB**  
Antique-Burnished Brass | Alabaster



**E** **KW2014BZ-ALB**  
Bronze | Alabaster



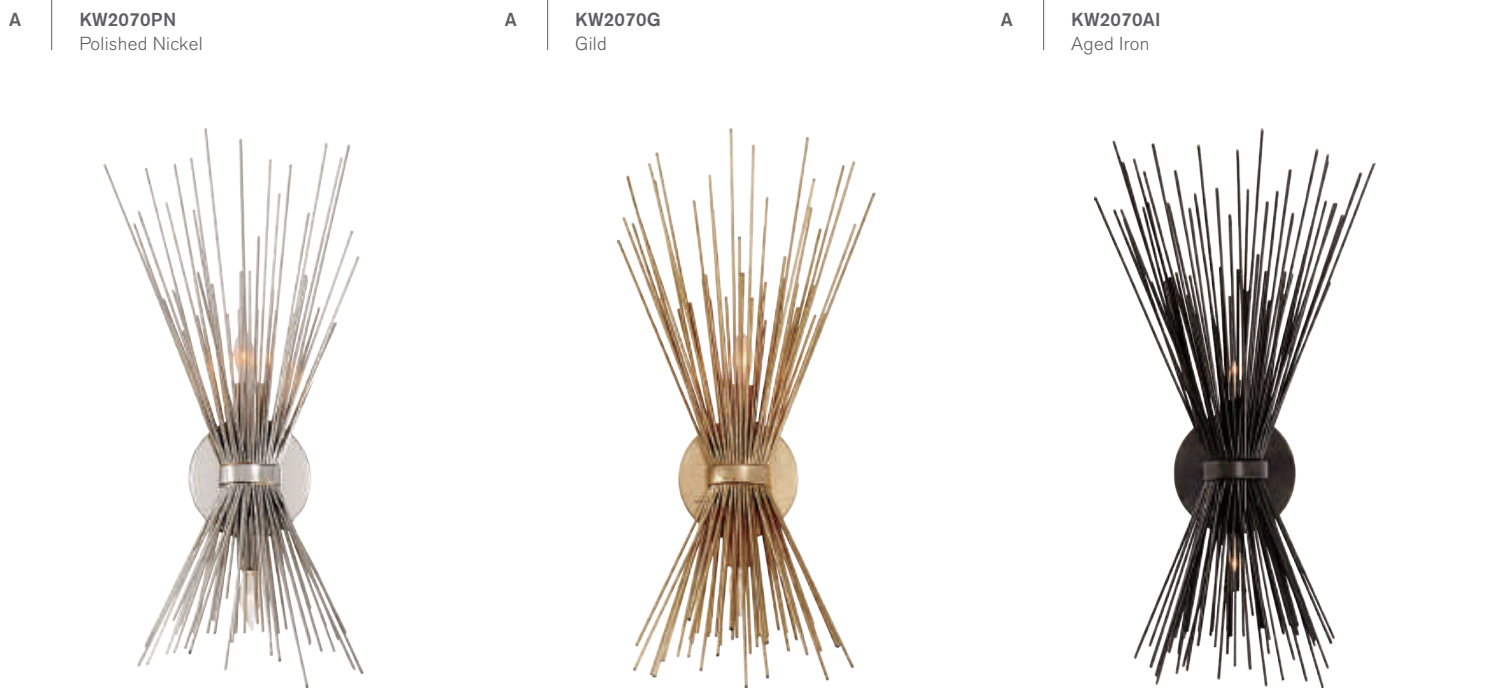

**A STRADA SMALL SCONCE**  
KELLY WEARSTLER

**KW2070**  
H: 19.5" | W: 8" | Ext: 5"  
Backplate: 4" Round  
Socket: 2 - E12 Candelabra | Bulb: 2 - 60 B  
**Additional Options:**  
Burnished Silver Leaf (BSL)

**B STRADA LARGE SCONCE**  
KELLY WEARSTLER

**KW2075**  
H: 36" | W: 12" | Ext: 8"  
Backplate: 5" x .5" Round  
Socket: 6 - E12 Candelabra | Bulb: 6 - 25 C  
**Additional Options:**  
Polished Nickel (PN)

opposite page

**C UTOPIA LARGE REFLECTOR SCONCE**  
KELLY WEARSTLER

**KW2054**  
H: 15" | W: 15" | Ext: 3.5"  
Backplate: 10" Round  
Socket: 2 - E12 Candelabra | Bulb: 2 - 60 C



**A KW2070G**  
Gild

**C KW2054G**  
Gild



**C KW2054AI**  
Aged Iron



**A** | **BBL2120BSL**  
Burnished Silver Leaf | Plaster White Interior



**A** | **BBL2120PW**  
Plaster White | Gild Interior



**A** | **BBL2120BZ**  
Bronze | Soft Brass Interior



**B** | **KW2271PN-WG**  
Polished Nickel | White Glass



**B** | **KW2271AB-WG**  
Antique-Burnished Brass | White Glass



opposite page

**A** | **AURA MEDIUM OVAL SCONCE**  
BARBARA BARRY

**BBL2120**  
H: 13.75" | W: 7.25" | Ext: 3"  
Backplate: 5.5" x 7" Oval  
Socket: 2 - E12 Candelabra | Bulb: 2 - 40 B

**C** | **BBL2092WHT**  
White



**C** | **BBL2092BSL**  
Burnished Silver Leaf



**C** | **BBL2092G**  
Gild



**C** | **BBL2092BLK**  
Matte Black



**B** | **NOUVEL SMALL SCONCE**  
KELLY WEARSTLER

**KW2271**  
H: 14.5" | W: 8.5" | Ext: 4.75"  
Backplate: 4.25" Round  
LED: 16w

**Additional Options:**  
Bronze | Antique-Burnished Brass | White Glass (BZ/AB-WG)

**C** | **HALO MEDIUM OVAL SCONCE**  
BARBARA BARRY

**BBL2092**  
H: 14" | W: 10.5" | Ext: 3.75"  
Backplate: 8.25" x 11.75" Oval  
LED: 12w



**A LEEDS SMALL ROUND SCONCE**  
CHRISTOPHER SPITZMILLER

**CS2605**  
H: 8.25" | W: 8.25" | Ext: 4"  
Backplate: 4.5" Round  
Socket: E12 Candelabara | Bulb: 40 C



**B LEEDS SMALL RECTANGLE SCONCE**  
CHRISTOPHER SPITZMILLER

**CS2609**  
H: 10.5" | W: 7" | Ext: 4"  
Backplate: 5" x 10" Rec.  
Socket: E12 Candelabara | Bulb: 40 C



**C GABRIELA ROUND WALL WASHER**  
AERIN

**ARN2450**  
H: 12" | W: 12" | Ext: 3.75"  
Backplate: 12" Round  
LED: 11w  
**Additional Options:**  
Polished Nickel (PN)  
Matte White (WHT)



**D NAILA SQUARE WALL WASHER**  
AERIN

**ARN2452**  
H: 14.25" | W: 10" | Ext: 3"  
Backplate: 10" Square  
LED: 11w  
**Additional Options:**  
Burnished Silver Leaf (BSL)  
Polished Nickel (PN)

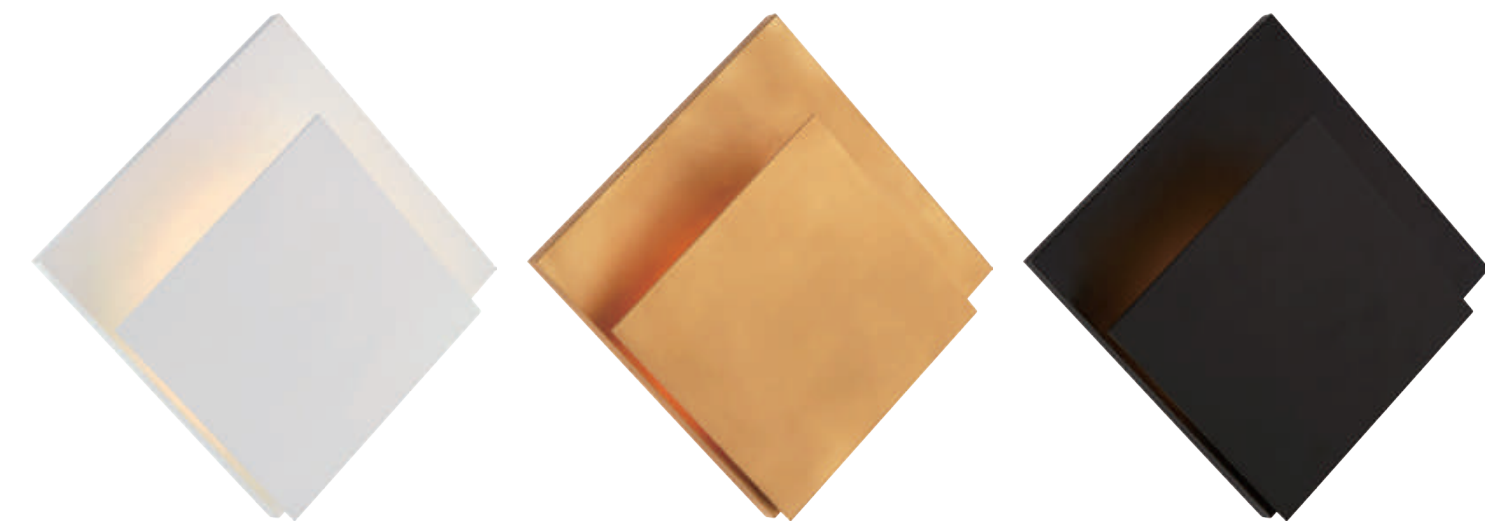



opposite page

**A** | **BEND LARGE TALL LIGHT**  
PETER BRISTOL

**PB2050**  
H: 20" | W: 8" | Ext: 4"  
Backplate: 7.75" x 14" Rec.  
LED: 18w  
**Additional Options:**  
Polished Nickel (PN)

**B** | **BEND MINI LIGHT**  
PETER BRISTOL

**PB2045**  
H: 11.5" | W: 3" | Ext: 2"  
Backplate: 3" x 8.25" Rec.  
LED: 8.5w  
**Additional Options:**  
White (WHT)

**C** | **BEND MEDIUM SQUARE LIGHT**  
PETER BRISTOL

**PB2052**  
H: 8" | W: 4.5" | Ext: 1.75"  
Backplate: 4" Square  
LED: 12w  
**Additional Options:**  
Matte Black (MBK)  
Natural Brass (NB)  
White (WHT)

**D** | **BEND LARGE SQUARE LIGHT**  
PETER BRISTOL

**PB2053**  
H: 11.5" | W: 10" | Ext: 3.5"  
Backplate: 5.75" x 10" Rec.  
LED: 18w  
**Additional Options:**  
Polished Nickel (PN)  
White (WT)

**E** | **BEND LARGE ROUND LIGHT**  
PETER BRISTOL

**PB2055**  
H: 11.5" | W: 12" | Ext: 3.75"  
Backplate: 5.5" x 11.75" Oval | LED: 18w  
**Additional Options:**  
White (WT)



**A** | **BBL2150SB-WHT**  
Soft Brass | White

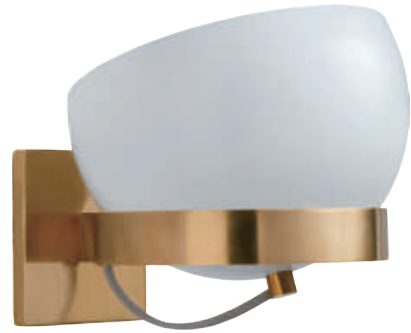

**A** | **BBL2150SB-BLK**  
Soft Brass | Black



**A** | **LIGHTWELL SMALL ROTATING SCONCE**  
BARBARA BARRY

**BBL2150**  
H: 7" | W: 8.75" | Ext: 11"  
Backplate: 5" Square  
Socket: E26 Keyless | Bulb: 40 A

**B** | **QUARTER SPHERE SMALL UP LIGHT**  
PETER BRISTOL

**PB2070**  
H: 5" | W: 10" | Ext: 5"  
Backplate: 5" x 10" Rec.  
LED: 12w  
**Additional Options:**  
Polished Nickel | Frosted Glass (PN-FG)

**B** | **PB2070WHT-FG**  
White | Frosted Glass



**B** | **PB2070NB-FG**  
Natural Brass | Frosted Glass

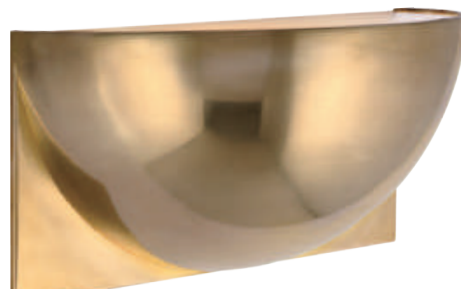

**B** | **PB2070MBK-FG**  
Matte Black | Frosted Glass



opposite page

**C** | **LOLA MEDIUM REFLECTOR SCONCE**  
IAN K. FOWLER

**S2260**  
H: 14.25" | W: 5.25" | Ext: 4"  
Backplate: 4.25" x 6" Rec.  
Socket: E12 Candelabra | Bulb: 40 T

**D** | **OSIRIS SINGLE REFLECTOR SCONCE**  
THOMAS O'BRIEN

**TOB2290**  
H: 10.25" | W: 9.25" | Ext: 6"  
Backplate: 6" Round  
Socket: E26 Keyless | Bulb: 40 A  
**Additional Options:**  
Hand-Rubbed Antique Brass | Linen (HAB-L)

**C** | **S2260AI**  
Aged Iron



**D** | **TOB2290PN-L**  
Polished Nickel | Linen



**D** | **TOB2290BZ/HAB-L**  
Bronze | Hand-Rubbed Antique Brass | Linen





A | **CHD2270AI-MG**  
Aged Iron | Antiqued Mercury Glass

A | **CHD2270GI-MG**  
Gilded Iron | Antiqued Mercury Glass



A | **LORFORD MEDIUM SCONCE**  
E. F. CHAPMAN  
  
**CHD2270**  
H: 23.75" | W: 14" | Ext: 9"  
Backplate: 2.25" x 4" Rec.  
Socket: 3 - E12 Candelabra | Bulb: 3 - 60 C  
©EFC DESIGNS

A | **CHD2270AI-MG**  
Aged Iron | Antiqued Mercury Glass



B | **GEORGIAN SMALL HURRICANE WALL SCONCE**  
E. F. CHAPMAN  
  
**CHD2102**  
H: 22" | W: 7.5" | Ext: 8.75"  
Backplate: 4.5" Round  
Socket: E12 Candelabra | Bulb: 60 C  
©EFC DESIGNS

B | **CHD2102PN**  
Polished Nickel



B | **CHD2102AB**  
Antique-Burnished Brass



B | **CHD2102AN**  
Antique Nickel



B | **CHD2102BZ**  
Bronze





WALL | FUNCTIONAL

**A** | **ARN2002HAB-L**  
Hand-Rubbed Antique Brass | Mahogany | Linen



**A** | **FRANKFORT ARTICULATING SCONCE**  
AERIN

**ARN2002**  
H: 22.5" | W: 5.5" | Ext: 5.5" - 30.5"  
Backplate: 3" X 13.5" Rec.  
Socket: 2 - E12 Candelabra | Bulb: 2 - 40 B  
Shade: 5.5" x 5.5" x 15"  
\* Requires Smaller Outlet Box

**A** | **ARN2002HAB-L**  
Hand-Rubbed Antique Brass | Mahogany | Linen



**A** | **ARN2002BLK-L**  
Black | Brass | Linen



**B** | **CLARKSON DOUBLE SCONCE**  
AERIN

**ARN2003**  
H: 16" | W: 21.5" | Ext: 11.5"  
Backplate: 4.5" Round  
Socket: 4 - E12 Candelabra | Bulb: 4 - 40 B  
Shade: 4.5" x 5.75" x 7.5"  
\* Toggle on Backplate

**B** | **ARN2003WHT-L**  
White | Brass | Linen



**B** | **ARN2003HAB-L**  
Hand-Rubbed Antique Brass | Linen



**B** | **ARN2003BLK-L**  
Black | Brass | Linen



**A** | **ARN2650HAB/WHT-L**  
Hand-Rubbed Antique Brass | White | Linen

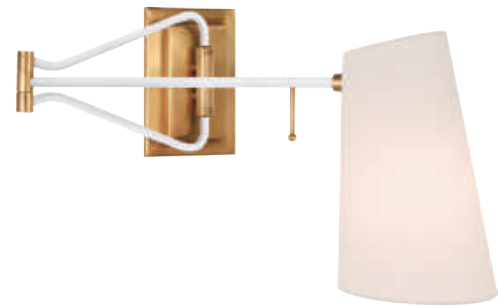

**A** | **ARN2650HAB-L**  
Hand-Rubbed Antique Brass | Linen



**A** | **ARN2650HAB/BLK-L**  
Hand-Rubbed Antique Brass | Black | Linen



opposite page

**A** | **KEIL SWING ARM SCONCE**  
AERIN

**ARN2650**  
H: 10" | W: 5.5" | Ext: 29"  
Backplate: 4.25" x 6.5" Rec.  
Socket: E26 On-Off | Bulb: 40 A  
Shade: 3.75" x 5.5" x 9"

**B** | **LARABEE DOUBLE SWING ARM SCONCE**  
kate spade new york

**KS2036**  
H: 19.5" | W: 5" | Ext: 18"  
Backplate: 4.5" Round  
Socket: 2 - E12 Candelabra | Bulb: 2 - 40 C  
Shade: 4" x 4" x 10"

**C** | **BBL2162SB-L**  
Soft Brass | Linen



**C** | **BBL2162BZ-L**  
Bronze | Linen



**B** | **KS2036PN-L**  
Polished Nickel | Linen



**B** | **KS2036SB-L**  
Soft Brass | Linen



**B** | **KS2036GM-L**  
Gun Metal | Linen



**D** | **BBL2164PN-L**  
Polished Nickel | Linen



**D** | **BBL2164BZ-L**  
Bronze | Linen



**C** | **SWEEP MEDIUM LEFT ARTICULATING SCONCE**  
BARBARA BARRY

**BBL2162**  
H: 13" | W: 11.75" | Ext: 11" - 29.75"  
Backplate: 4.5" x 6.25" Rec.  
Socket: E26 Dimmer | Bulb: 40 A  
Shade: 11" x 11.75" 8.75"  
**Additional Options:**  
Polished Nickel | Linen (PN-L)

**D** | **SWEEP MEDIUM RIGHT ARTICULATING SCONCE**  
BARBARA BARRY

**BBL2164**  
H: 13" | W: 11.75" | Ext: 11" - 29.75"  
Backplate: 4.5" x 6.25" Rec.  
Socket: E26 Dimmer | Bulb: 40 A  
Shade: 11" x 11.75" 8.75"  
**Additional Options:**  
Soft Brass | Linen (SB-L)

**A** | **BBL2027SB-L**  
Soft Brass | Linen



**A** | **BBL2027BZ-L**  
Bronze | Linen



**A** | **ASPECT LIBRARY SCONCE**  
BARBARA BARRY

**BBL2027**  
H: 14.5" | W: 6" | Ext: 7.5"  
Backplate: 2.125" x 4.75" Rec.  
Socket: E26 Keyless | Bulb: 60 B  
Shade: 5.5" x 6" x 7.25"  
**Additional Options:**  
Pewter | Linen (PWT-L)  
Polished Nickel | Linen (PN-L)  
Soft Silver | Linen (SS-L)  
\* Requires Smaller Outlet Box

**B** | **ASPECT SMALL ARTICULATING SCONCE**  
BARBARA BARRY

**BBL2028**  
H: 16.75" | W: 7.75" | Ext: 11"  
Backplate: 4.5" Square  
Socket: E26 Dimmer | Bulb: 75 A  
Shade: 7.25" x 7.75" x 8.25"  
**Additional Options:**  
Pewter | Linen (PWT-L)  
Soft Silver | Linen (SS-L)  
\* Cord Cover Included

**C** | **ASPECT LARGE ARTICULATING SCONCE**  
BARBARA BARRY

**BBL2029**  
H: 18.5" | W: 10" | Ext: 13.5"  
Backplate: 4.5" Square  
Socket: E26 Dimmer | Bulb: 100 A  
Shade: 9.5" x 10" x 9.5"  
**Additional Options:**  
Soft Silver | Linen (SS-L)  
\* Cord Cover Included

**B** | **BBL2028PN-L**  
Polished Nickel | Linen



**B** | **BBL2028SB-L**  
Soft Brass | Linen



**B** | **BBL2028BZ-L**  
Bronze | Linen



**C** | **BBL2029PWT-L**  
Pewter | Linen



**C** | **BBL2029PN-L**  
Polished Nickel | Linen



**C** | **BBL2029SB-L**  
Soft Brass | Linen



**C** | **BBL2029BZ-L**  
Bronze | Linen







**A** **SK2115PN-NP**  
Polished Nickel | Natural Paper

**A** **SK2115AN-NP**  
Antique Nickel | Natural Paper

**A** **SK2115HAB-NP**  
Hand-Rubbed Antique Brass | Natural Paper

**A** **SK2115BZ-NP**  
Bronze | Natural Paper

**A** **GRAVES PIVOTING SCONCE**  
SUZANNE KASLER

**SK2115**  
H: 16.5" | W: 8" | Ext: 10.5" - 22"  
Backplate: 4" x 5.5" Rec.  
Socket: E26 Pull Chain | Bulb: 60 B  
Shade: 4.5" x 8" x 7.5"  
\* Cord Cover Included



**B** **BBL2010PN-S**  
Polished Nickel | Silk

**B** **BBL2010SS-S**  
Soft Silver | Silk

**B** **BBL2010SB-S**  
Soft Brass | Silk

**B** **BBL2010BZ-S**  
Bronze | Silk

**B** **UNDERSTUDY SCONCE**  
BARBARA BARRY

**BBL2010**  
H: 18" | W: 10" | Ext: 22" - 25"  
Backplate: 5.25" Round  
Socket: E26 Keyless | Bulb: 60 A  
Shade: 9" x 10" x 10"



**A** **SK2115HAB-NP**  
Hand-Rubbed Antique Brass | Natural Paper

**A HUDSON SWING ARM SCONCE**  
THOMAS O'BRIEN

**TOB2204**  
H: 11" | W: 12" | Ext: 13.5" - 28.5"  
Backplate: 3" x 4.75" Rec.  
Socket: E26 On-Off | Bulb: 60 A  
Shade: 12" x 12" x 7.5"  
\* Cord Cover Included  
\* Requires Smaller Outlet Box

**B PAULO SMALL SWING ARM SCONCE**  
THOMAS O'BRIEN

**TOB2203**  
H: 16" | W: 11" | Ext: 15" - 26"  
Backplate: 3.5" x 7.25" Rec.  
Socket: E26 Dimmer | Bulb: 100 A  
Shade: 8.5" x 11" x 8.5"  
**Additional Options:**  
Bronze | Natural Paper (BZ-NP)  
\* Cord Cover Included  
\* Requires Smaller Outlet Box

**C PAULO LARGE SWING ARM SCONCE**  
THOMAS O'BRIEN

**TOB2201**  
H: 18" | W: 18" | Ext: 33" - 51"  
Backplate: 3.5" x 7.25" Rec.  
Socket: E26 Dimmer | Bulb: 100 A  
Shade: 15" x 17.5" x 10"  
**Additional Options:**  
Hand-Rubbed Antique Brass | Natural Paper (HAB-NP)  
Polished Nickel | Natural Paper (PN-NP)  
\* Cord Cover Included  
\* Requires Smaller Outlet Box

**A TOB2204PN-NP**  
Polished Nickel | Natural Paper



**A TOB2204PN-NP**  
Polished Nickel | Natural Paper

**A TOB2204AN-NP**  
Antique Nickel | Natural Paper

**A TOB2204HAB-NP**  
Hand-Rubbed Antique Brass | Natural Paper

**A TOB2204BZ-NP**  
Bronze | Natural Paper



**B TOB2203PN-NP**  
Polished Nickel | Natural Paper

**B TOB2203HAB-NP**  
Hand-Rubbed Antique Brass | Natural Paper

**C TOB2201BZ-NP**  
Bronze | Natural Paper



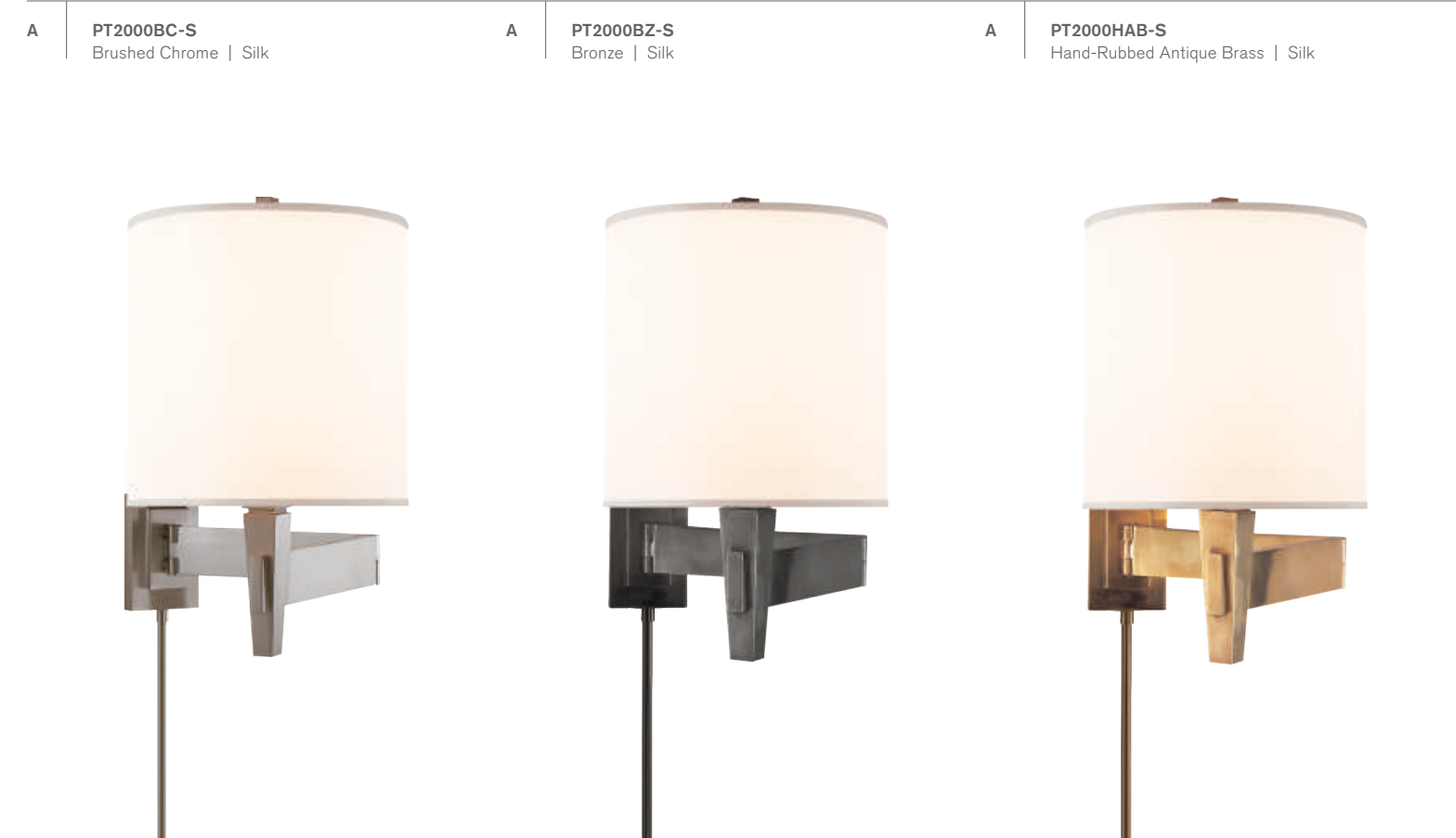

**A** **PT2000BC-S**  
Brushed Chrome | Silk

**A** **PT2000BZ-S**  
Bronze | Silk

**A** **PT2000HAB-S**  
Hand-Rubbed Antique Brass | Silk

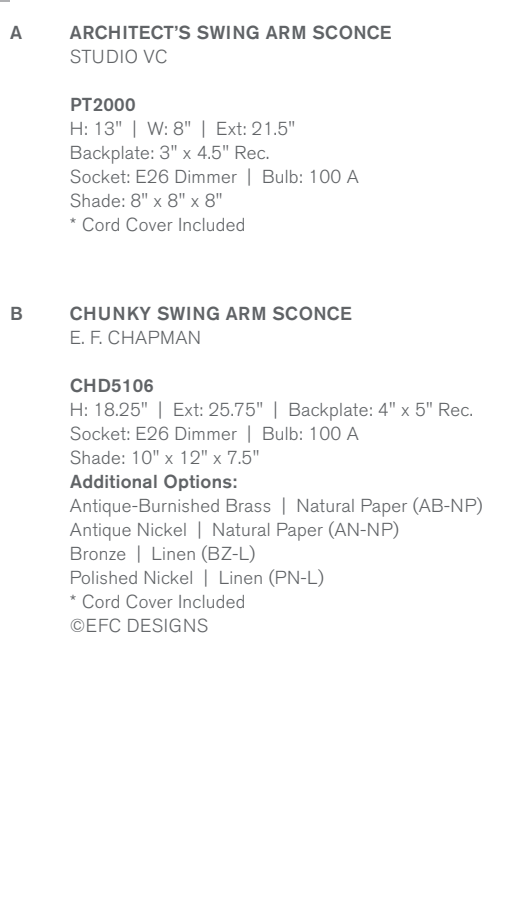

**A** **ARCHITECT'S SWING ARM SCONCE**  
STUDIO VC

**PT2000**  
H: 13" | W: 8" | Ext: 21.5"  
Backplate: 3" x 4.5" Rec.  
Socket: E26 Dimmer | Bulb: 100 A  
Shade: 8" x 8" x 8"  
\* Cord Cover Included

**B** **CHUNKY SWING ARM SCONCE**  
E. F. CHAPMAN

**CHD5106**  
H: 18.25" | Ext: 25.75" | Backplate: 4" x 5" Rec.  
Socket: E26 Dimmer | Bulb: 100 A  
Shade: 10" x 12" x 7.5"  
**Additional Options:**  
Antique-Burnished Brass | Natural Paper (AB-NP)  
Antique Nickel | Natural Paper (AN-NP)  
Bronze | Linen (BZ-L)  
Polished Nickel | Linen (PN-L)  
\* Cord Cover Included  
©EFC DESIGNS

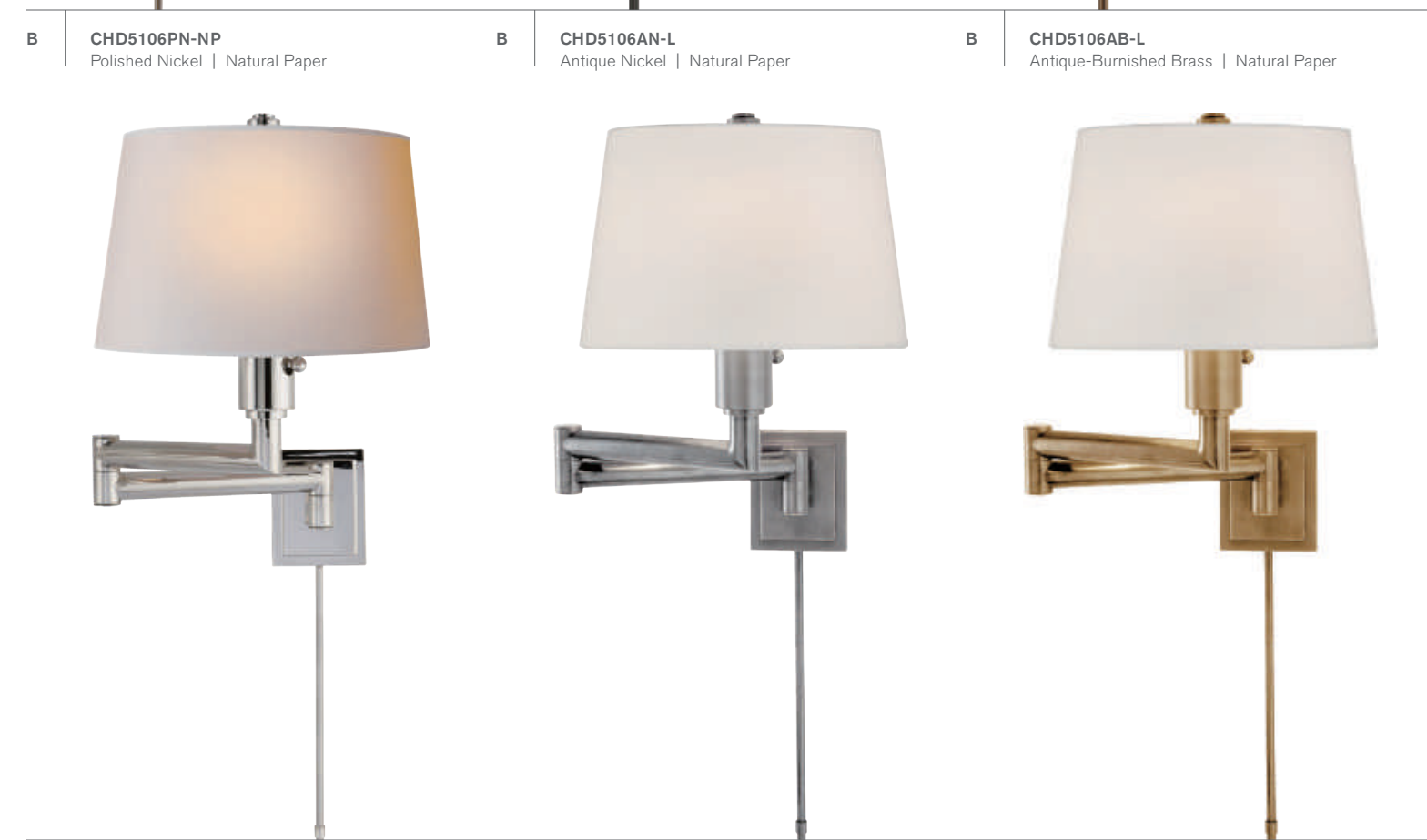

**B** **CHD5106PN-NP**  
Polished Nickel | Natural Paper

**B** **CHD5106AN-L**  
Antique Nickel | Natural Paper

**B** **CHD5106AB-L**  
Antique-Burnished Brass | Natural Paper

**B** **CHD5106BZ-NP**  
Bronze | Natural Paper



**B** **CHD5106BZ-NP**  
Bronze | Natural Paper



**C** **WALKER SWING ARM SCONCE**  
KATE SPADE NEW YORK

**KS2075**  
H: 11.5" | W: 12" | Ext: 16" - 25.25"  
Backplate: 5" Round  
Socket: E26 Keyless | Bulb: 60 A  
Shade: 12" x 12" x 6.5"

**D** **CLASSIC SWING ARM SCONCE**  
STUDIO VC

**92000D**  
H: 11" | W: 12" | Ext: 25"  
Backplate: 4.5" Square  
Socket: E26 Dimmer | Bulb: 75 A  
Shade: 6" x 12" x 7"  
**Additional Options:**  
Antique Nickel | Linen (AN-L)  
\* Cord Cover Included

**C** **KS2075LC-NL**  
Light Cream | Natural Linen

**C** **KS2075BSL-L**  
Burnished Silver Leaf | Cream Linen

**C** **KS2075G-L/BL**  
Gild | Cream Linen | Black Linen

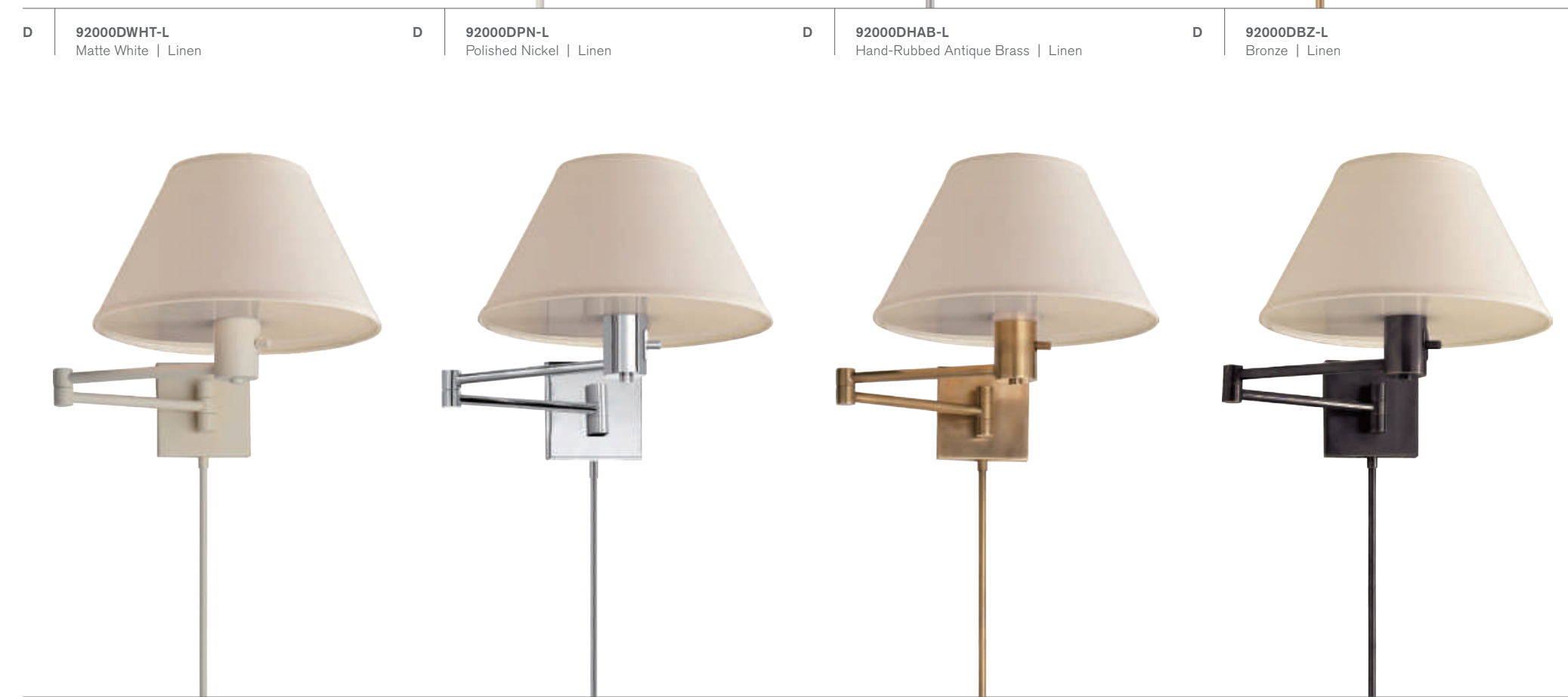

**D** **92000DWH-L**  
Matte White | Linen

**D** **92000DPN-L**  
Polished Nickel | Linen

**D** **92000DHAB-L**  
Hand-Rubbed Antique Brass | Linen

**D** **92000DBZ-L**  
Bronze | Linen

A AH2012PN-S  
Polished Nickel | Silk



**A GENE SWING ARM SCONCE**  
ALEXA HAMPTON

**AH2012**  
H: 15" | W: 12" | Ext: 12.75" - 19.5"  
Backplate: 3.5" x 5" Rec.  
Socket: E26 Hi-Lo | Bulb: 100 A  
Shade: 7" x 12" x 9"  
\* Cord Cover Included

**B PRIMITIVE SWING ARM SCONCE**  
STUDIO VC

**S2500**  
H: 14" | W: 12" | Ext: 18.25"  
Backplate: 3.5" x 5" Rec.  
Socket: E26 Hi-Lo | Bulb: 75 A  
Shade: 5" x 12" x 8.75"  
**Additional Options:**  
Antique Nickel | Natural Paper (AN-NP)  
Hand-Rubbed Antique Brass | Natural Paper (HAB-NP)  
\* Cord Cover Included  
\* Requires Smaller Outlet Box

**C GRIFFITH SWING ARM**  
SUZANNE KASLER

**SK2109**  
H: 16" | W: 10" | Ext: 24"  
Backplate: 5" Square  
Socket: E26 Dimmer | Bulb: 100 A  
Shade: 7.25" x 10" x 8"  
\* Cord Cover Included

A AH2012PN-S  
Polished Nickel | Silk



B S2500AN-L  
Antique Nickel | Linen



A AH2012NB-S  
Natural Brass | Silk



B S2500HAB-L  
Hand-Rubbed Antique Brass | Linen



A AH2012BN-S  
Brushed Nickel | Silk



C SK2109GI-NP  
Gilded Iron | Natural Paper



A AH2012GM-S  
Gun Metal | Silk



C SK2109AI-NP  
Aged Iron | Natural Paper



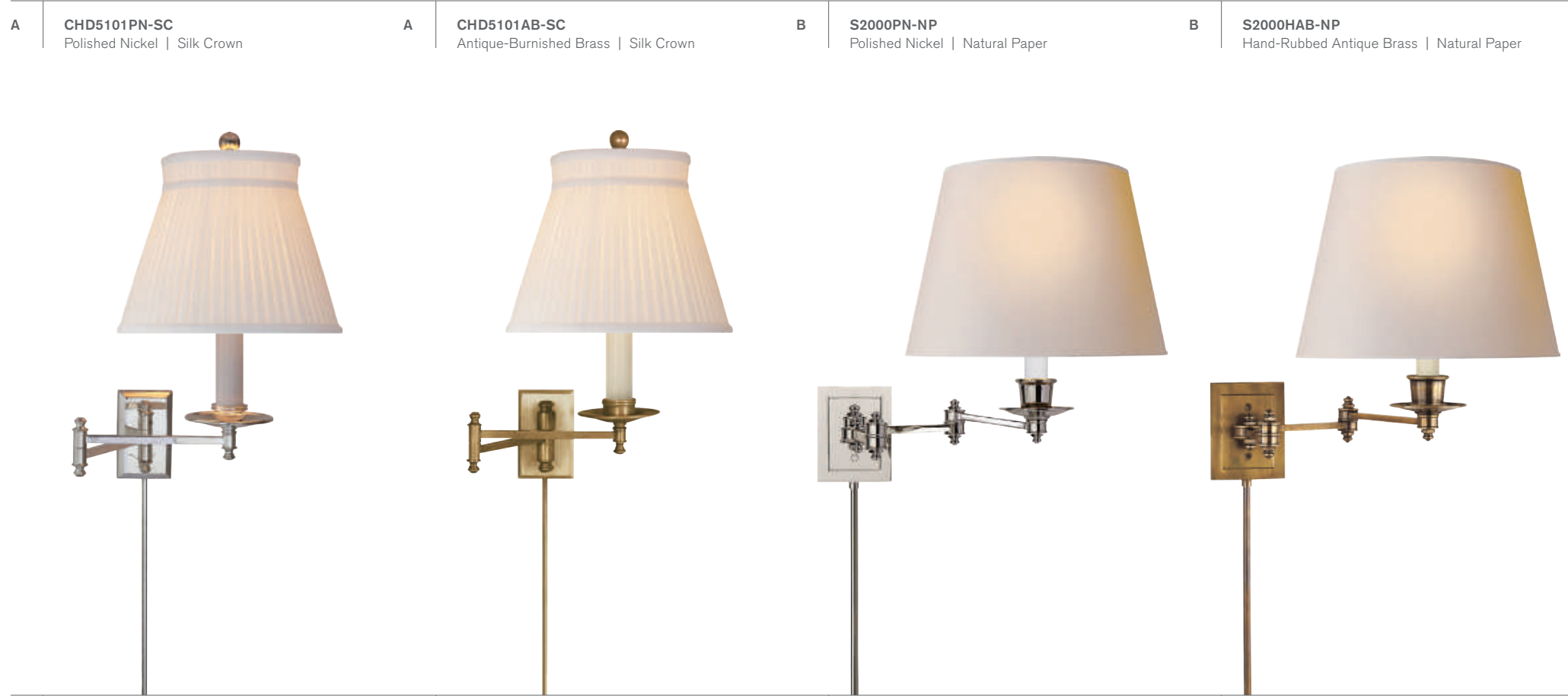

**A** **CHD5101PN-SC**  
Polished Nickel | Silk Crown

**A** **CHD5101AB-SC**  
Antique-Burnished Brass | Silk Crown

**B** **S2000PN-NP**  
Polished Nickel | Natural Paper

**B** **S2000HAB-NP**  
Hand-Rubbed Antique Brass | Natural Paper



**C** **S2010PN-S**  
Polished Nickel | Silk

**C** **S2010HAB-S**  
Hand-Rubbed Antique Brass | Silk

**C** **S2010PN-NP**  
Polished Nickel | Natural Paper

**C** **S2010HAB-NP**  
Hand-Rubbed Antique Brass | Natural Paper

opposite page

**A DORCHESTER SWING ARM SCENCE**  
E. F. CHAPMAN

**CHD5101**  
H: 15" | Ext: 22" | Backplate: 2.25" x 4.5" Rec.  
Socket: E26 Hi-Lo | Bulb: 100 A  
Shade: 6" x 10" x 8"  
**Additional Options:**  
Antique-Burnished Brass | Black (AB-B)  
Antique Nickel | Silk Crown (AN-SC)  
\* Cord Cover Included  
©EFC DESIGNS

**B TRIPLE SWING ARM SCENCE**  
STUDIO VC

**S2000**  
H: 13" | Ext: 18.5" | Backplate: 3.5" x 4.5" Rec.  
Socket: E26 Dimmer | Bulb: 100 A  
Shade: 8" x 11" x 8.25"  
**Available Options:**  
Antique Nickel (AN)  
Bronze (BZ)  
Hand-Rubbed Antique Brass (HAB)  
Polished Nickel (PN)  
Natural Paper (NP)  
Linen (L)  
Silk (S)  
\* Cord Cover Included  
\* Requires Smaller Outlet Box

**C CANDLESTICK SWING ARM SCENCE**  
STUDIO VC

**S2010**  
H: 16" | Ext: 19" | Backplate: 5" Round  
Socket: E26 Dimmer | Bulb: 60 A  
Shade: 5" x 11" x 8.25"  
**Additional Options:**  
Antique Nickel | Natural Paper (AN-NP)  
Antique Nickel | Silk (AN-S)  
Bronze | Natural Paper (BZ-NP)  
Bronze | Silk (BZ-S)  
\* Cord Cover Included

**D DORCHESTER DOUBLE SWING ARM SCENCE**  
E. F. CHAPMAN

**CHD5102**  
H: 27" | Ext: 24" | Backplate: 2.5" x 4" Rec.  
Socket: E26 Hi-Lo | Bulb: 100 A  
Shade: 6" x 10" x 7"  
**Additional Options:**  
Antique-Burnished Brass | Black Natural Paper (AB-B)  
Antique Nickel | Natural Paper (AN-NP)  
Polished Nickel | Natural Paper (PN-NP)  
\* Cord Cover Included  
©EFC DESIGNS



**D** **CHD5102AB-NP**  
Antique-Burnished Brass | Natural Paper



**A** | **SL2920PN-L**  
Polished Nickel | Linen

**A** | **SL2920AN-L**  
Antique Nickel | Linen

**A** | **SL2920HAB-L**  
Hand-Rubbed Antique Brass | Linen

**A** | **SL2920BZ-L**  
Bronze | Linen



**B** | **CHD2154PN-NP**  
Polished Nickel | Natural Paper

**B** | **CHD2154AN-NP**  
Antique Nickel | Natural Paper

**B** | **CHD2154AB-NP**  
Antique-Burnished Brass | Natural Paper

**A BOSTON SWING ARM**  
E. F. CHAPMAN

**SL2920**  
H: 13" | Ext: 13" | Backplate: 5" Round  
Socket: E26 Hi-Lo | Bulb: 60 A  
Shade: 8" x 12" x 7"  
\* Cord Cover Included  
©EFC DESIGNS

**B PIMLICO SWING ARM SCONCE**  
E. F. CHAPMAN

**CHD2154**  
H: 17" | Ext: 25" | Backplate: 3" x 6.5" Rec.  
Socket: E26 Hi-Lo | Bulb: 60 A  
Shade: 7" x 12" x 9"  
\* Cord Cover Included  
©EFC DESIGNS



**B** | **CHD2154AB-LCC**  
Antique-Burnished Brass | Linen Collar



**B** | **CHD2154PN-LCC**  
Polished Nickel | Linen Collar



**B** | **CHD2154AN-LCC**  
Antique Nickel | Linen Collar

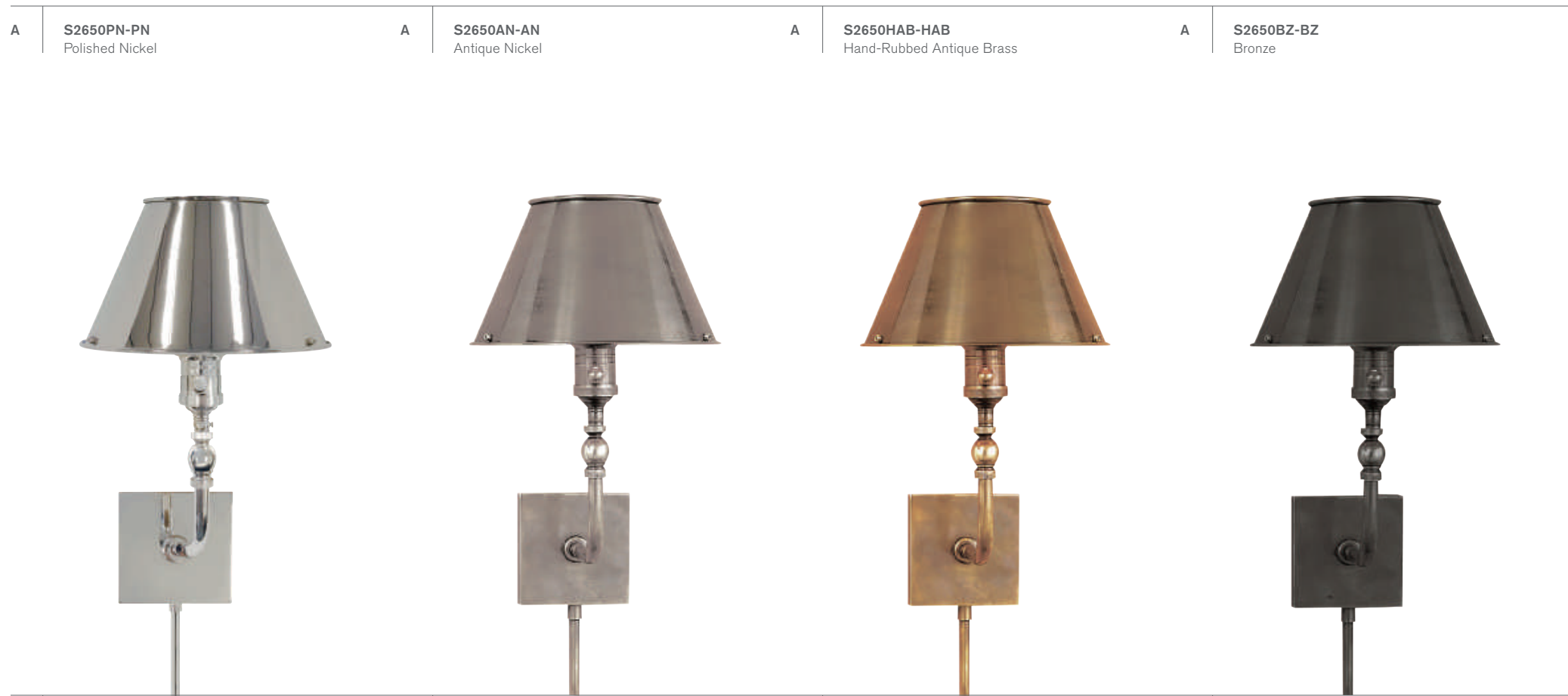

<b>A</b>	<b>S2650PN-PN</b> Polished Nickel	<b>A</b>	<b>S2650AN-AN</b> Antique Nickel	<b>A</b>	<b>S2650HAB-HAB</b> Hand-Rubbed Antique Brass	<b>A</b>	<b>S2650BZ-BZ</b> Bronze
----------	--------------------------------------	----------	-------------------------------------	----------	--	----------	-----------------------------

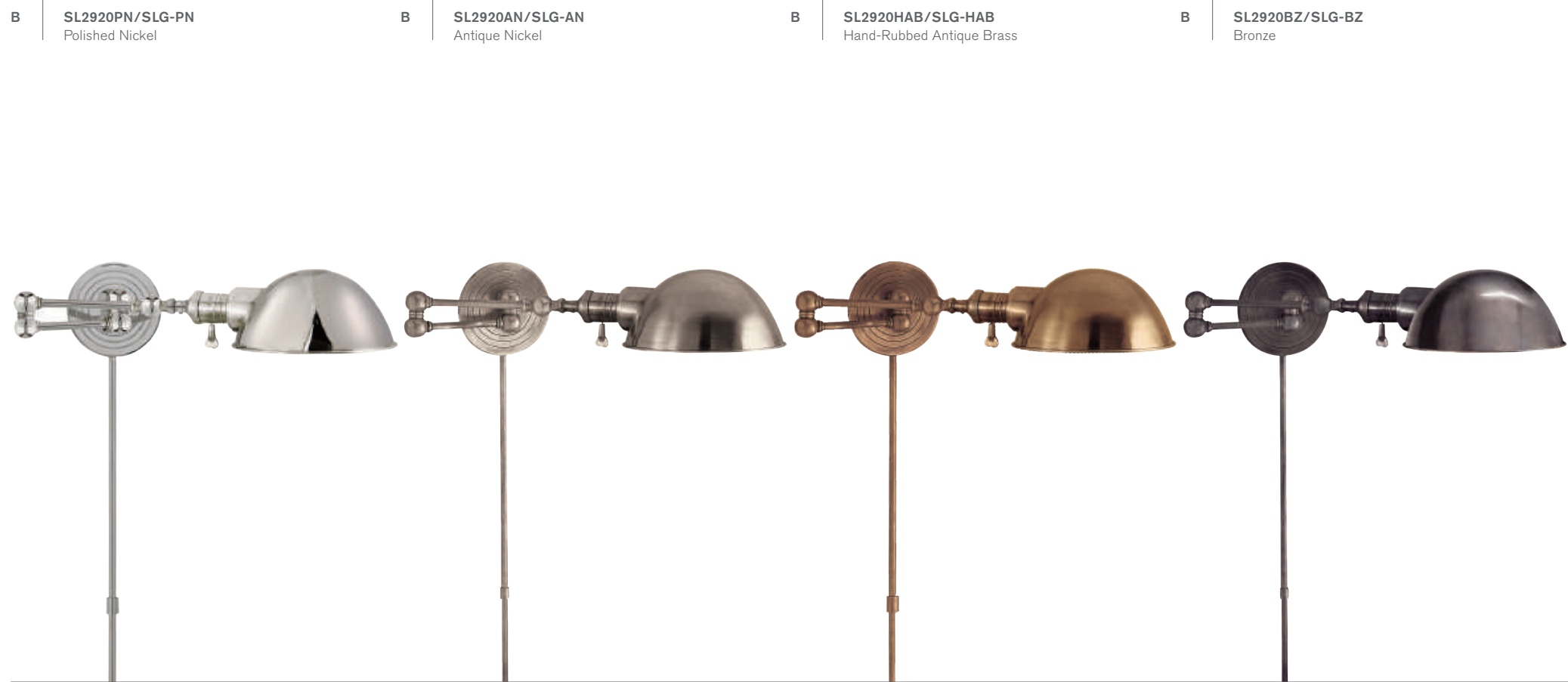

<b>B</b>	<b>SL2920PN/SLG-PN</b> Polished Nickel	<b>B</b>	<b>SL2920AN/SLG-AN</b> Antique Nickel	<b>B</b>	<b>SL2920HAB/SLG-HAB</b> Hand-Rubbed Antique Brass	<b>B</b>	<b>SL2920BZ/SLG-BZ</b> Bronze
----------	---	----------	--	----------	---	----------	----------------------------------

opposite page

**A SWIVEL HEAD SCONCE**  
STUDIO VC

**S2650**  
H: 14" | W: 8" | Ext: 9.5"  
Backplate: 4" Square  
Socket: E26 Hi-Lo | Bulb: 60 A  
Shade: 4" x 8" x 5"  
\* Cord Cover Included

**B BOSTON SWING ARM**  
E. F. CHAPMAN

**SL2920**  
H: 5" | Ext: 13" | Backplate: 5" Round  
Socket: E26 Hi-Lo | Bulb: 60 A  
Shade: 3.5" x 7" SLG Round  
**Additional Options:**  
Antique Nickel | SLE (AN/SLE-AN)  
Bronze | SLE (BZ/SLE-BZ)  
Hand-Rubbed Antique Brass | SLE (HAB/SLE-HAB)  
\* Cord Cover Included  
©EFC DESIGNS

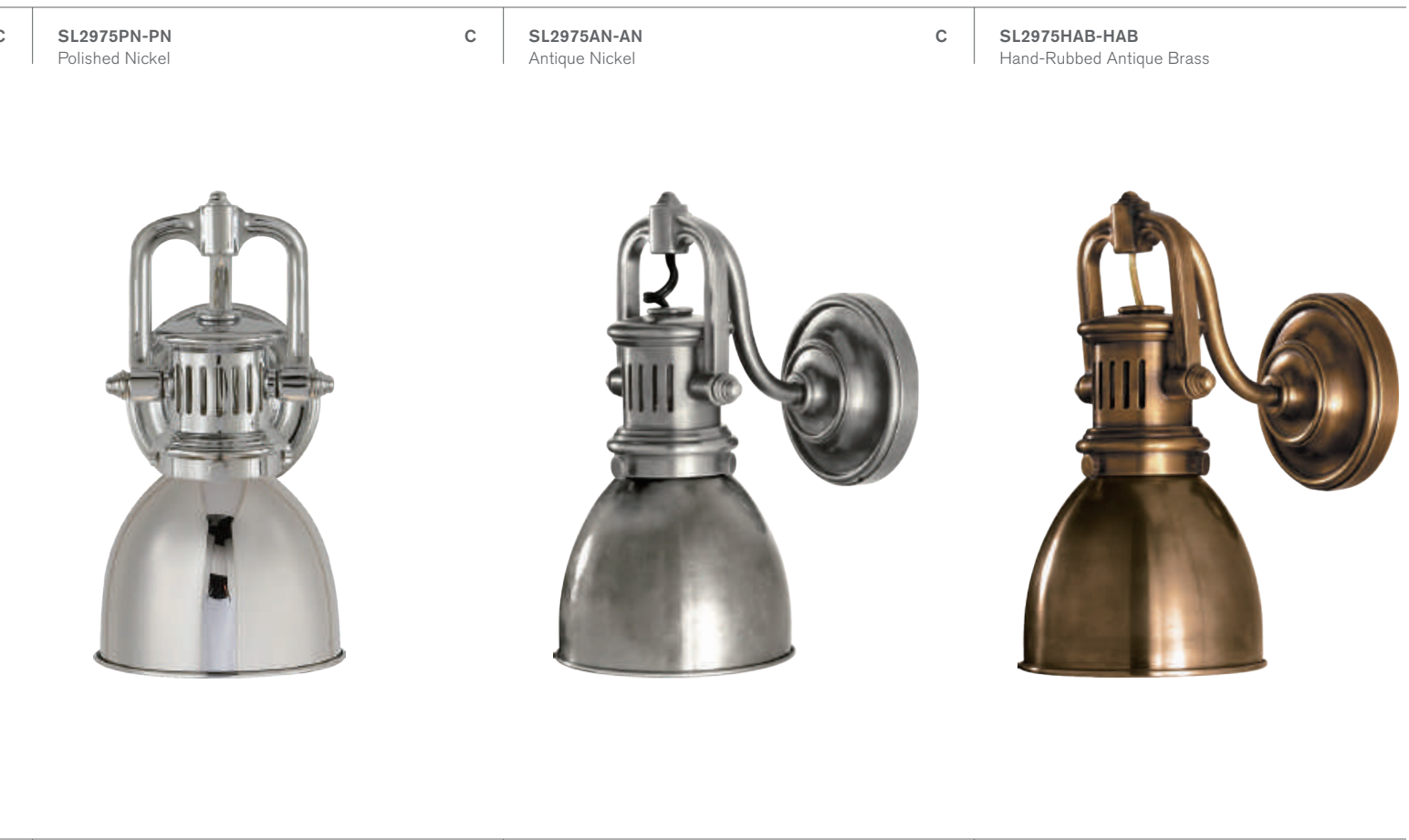

<b>C</b>	<b>SL2975PN-PN</b> Polished Nickel	<b>C</b>	<b>SL2975AN-AN</b> Antique Nickel	<b>C</b>	<b>SL2975HAB-HAB</b> Hand-Rubbed Antique Brass
----------	---------------------------------------	----------	--------------------------------------	----------	---

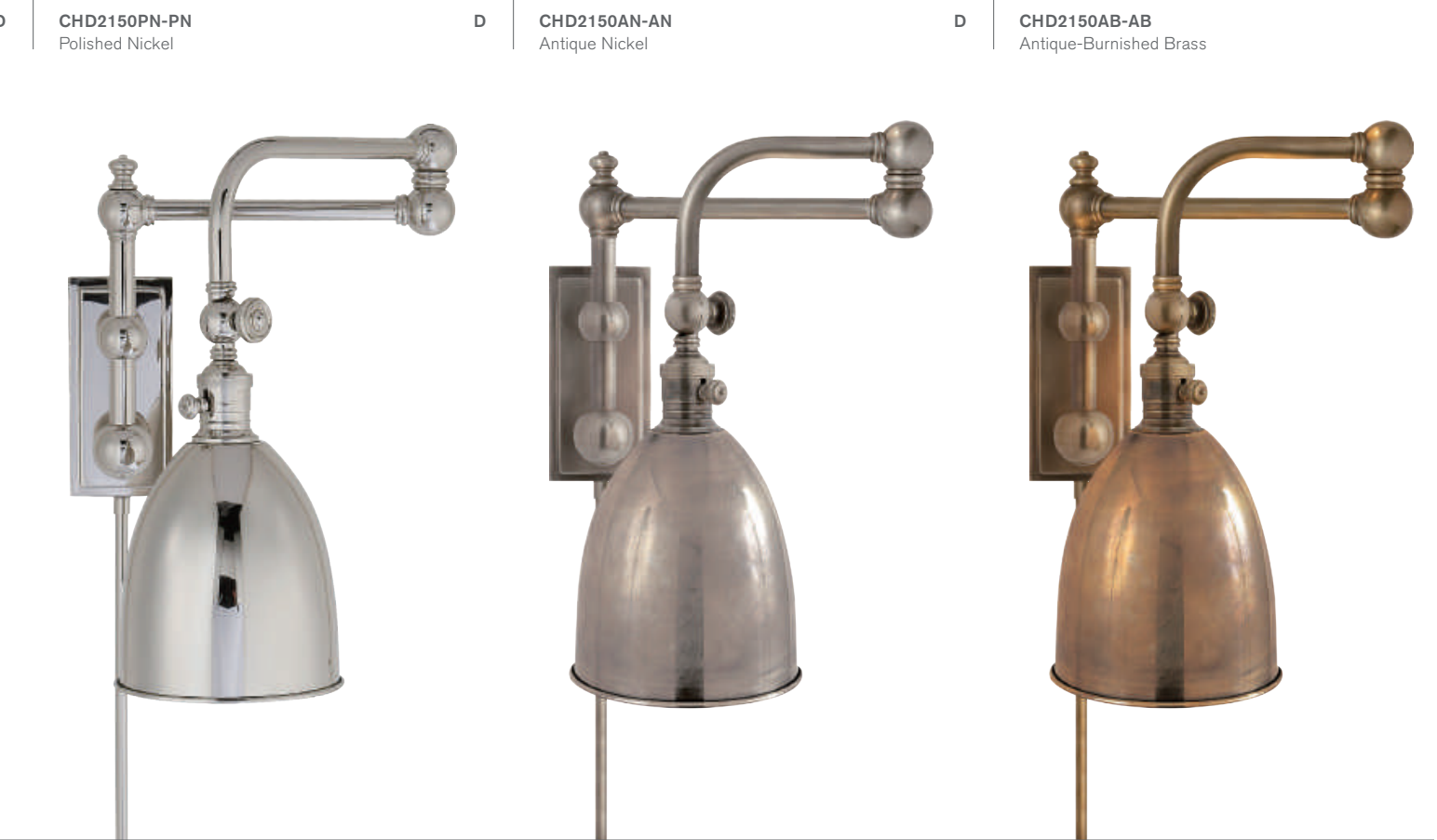

<b>D</b>	<b>CHD2150PN-PN</b> Polished Nickel	<b>D</b>	<b>CHD2150AN-AN</b> Antique Nickel	<b>D</b>	<b>CHD2150AB-AB</b> Antique-Burnished Brass
----------	--	----------	---------------------------------------	----------	--

**C YOKE SUSPENDED SCONCE**  
E. F. CHAPMAN

**SL2975**  
H: 10.25" | W: 5" | Ext: 9.5"  
Backplate: 4.5" Round  
Socket: E26 Keyless | Bulb: 60 A  
\* Shade has White Interior  
©EFC DESIGNS

**D PIMLICO DOUBLE SWING ARM SCONCE**  
E. F. CHAPMAN

**CHD2150**  
H: 16" | Ext: 28" | Backplate: 3" x 6.5" Rec.  
Socket: E26 Hi-Lo | Bulb: 60 A  
\* Cord Cover Included  
©EFC DESIGNS



A | **82034AN**  
Antique Nickel

A | **STUDIO SWING ARM SCONCE**  
STUDIO VC

**82034**  
H: 4.5" | Ext: 24" | Backplate: 4.5" Square  
Socket: E26 Dimmer | Bulb: 40 J  
\* Cord Cover Included

B | **STUDIO PHARMACY SCONCE**  
STUDIO VC

**92025**  
H: 4.5" | Ext: 25" | Backplate: 4.5" Square  
Socket: E26 Dimmer | Bulb: 60 T  
\* Cord Cover Included

A | **82034PN**  
Polished Nickel

A | **82034AN**  
Antique Nickel

A | **82034HAB**  
Hand-Rubbed Antique Brass

A | **82034BZ**  
Bronze

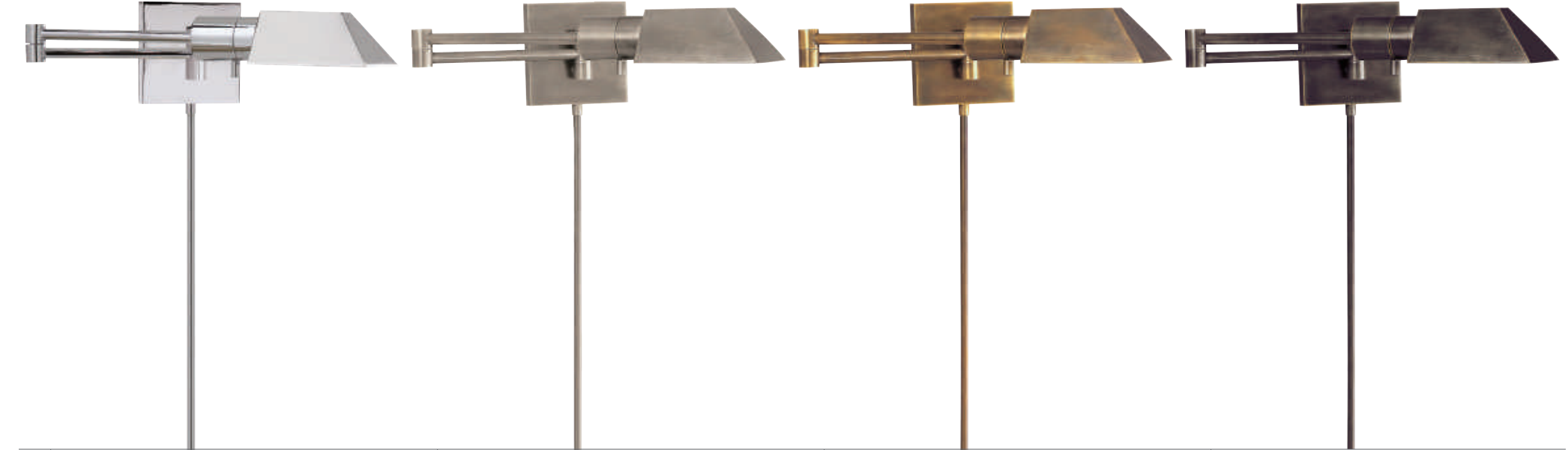

B | **92025PN**  
Polished Nickel

B | **92025AN**  
Antique Nickel

B | **92025HAB**  
Hand-Rubbed Antique Brass

B | **92025BZ**  
Bronze





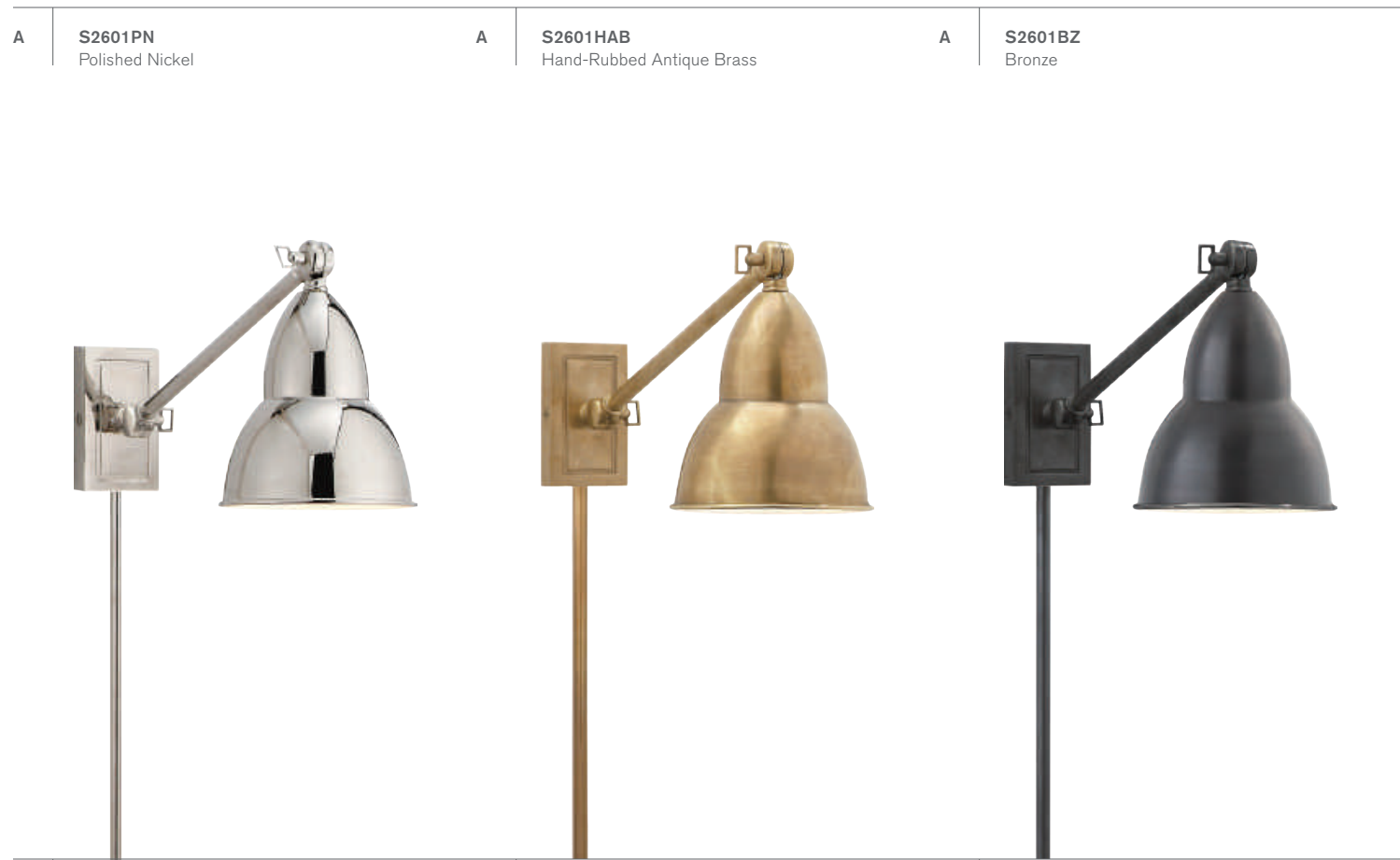

**A** **S2601PN** Polished Nickel      **A** **S2601HAB** Hand-Rubbed Antique Brass      **A** **S2601BZ** Bronze

**A FRENCH LIBRARY SINGLE ARM SCONCE**  
STUDIO VC

**S2601**  
H: 7.5" - 19" | W: 5.75" | Ext: 20"  
Backplate: 2.5" x 4.5" Rec.  
Socket: E26 Keyless | Bulb: 50 Par  
**Additional Options:**  
Antique Nickel (AN)  
\* Cord Cover Included  
\* Line Switch

**B FRENCH LIBRARY DOUBLE ARM SCONCE**  
STUDIO VC

**S2602**  
H: 7.5" - 24" | W: 5.75" | Ext: 16" - 31"  
Backplate: 2.5" x 4.5" Rec.  
Socket: E26 Keyless | Bulb: 50 Par  
**Additional Options:**  
Antique Nickel (AN)  
\* Cord Cover Included  
\* Line Switch



**B** **S2602PN** Polished Nickel      **B** **S2602HAB** Hand-Rubbed Antique Brass      **B** **S2602BZ** Bronze

opposite page

**C BOSTON SINGLE ARM LIBRARY LIGHT**  
E. F. CHAPMAN

**SL2922**  
H: 11" | Ext: 17.5" | Backplate: 4.75" Round  
Socket: E26 Hi-Lo | Bulb: 60  
\* Cord Cover Included  
©EFC DESIGNS

**D BOSTON DOUBLE ARM LIBRARY LIGHT**  
E. F. CHAPMAN

**SL2923**  
H: 16" | Ext: 15.5" | Backplate: 4.5" Round  
Socket: E26 Hi-Lo | Bulb: 60 A  
\* Cord Cover Included  
\* Adjusts Vertically Only  
©EFC DESIGNS

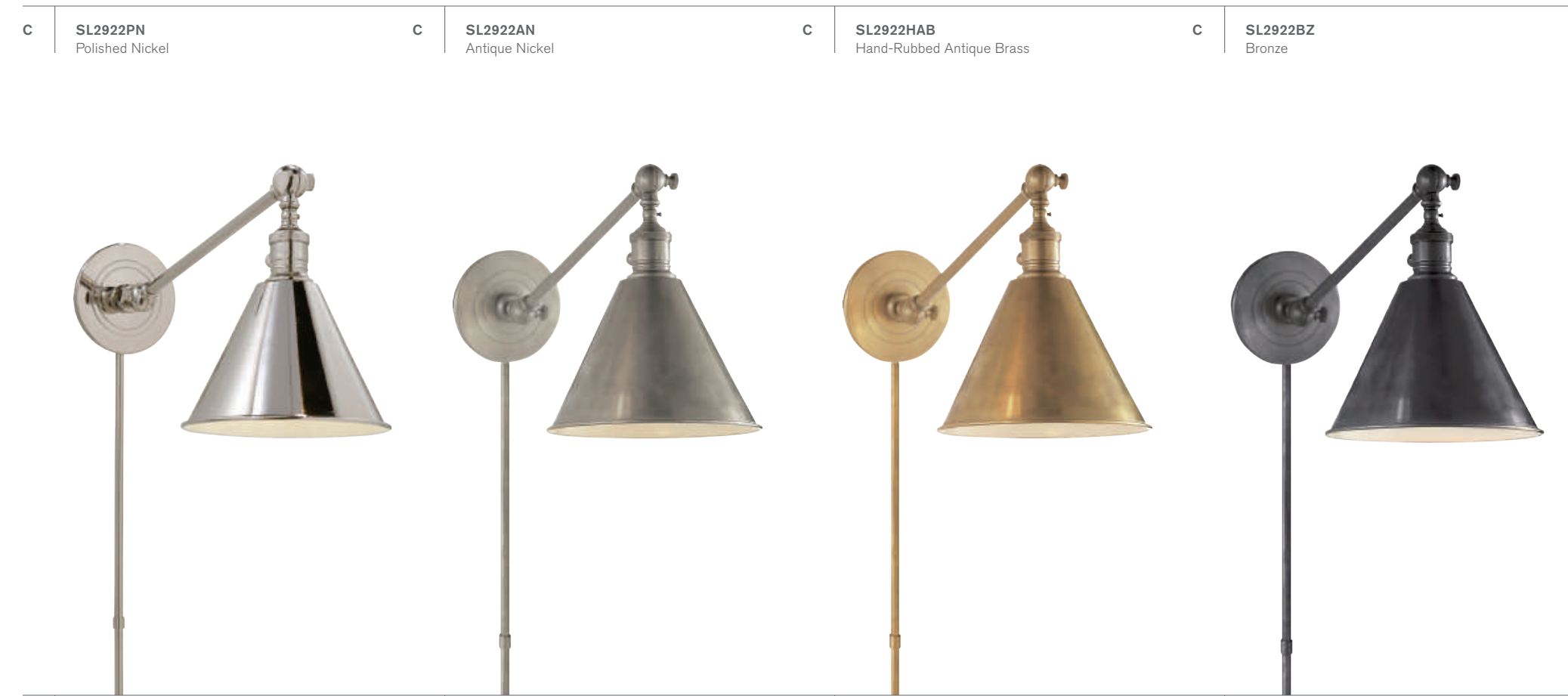

**C** **SL2922PN** Polished Nickel      **C** **SL2922AN** Antique Nickel      **C** **SL2922HAB** Hand-Rubbed Antique Brass      **C** **SL2922BZ** Bronze



**D** **SL2923PN** Polished Nickel      **D** **SL2923AN** Antique Nickel      **D** **SL2923HAB** Hand-Rubbed Antique Brass      **D** **SL2923BZ** Bronze

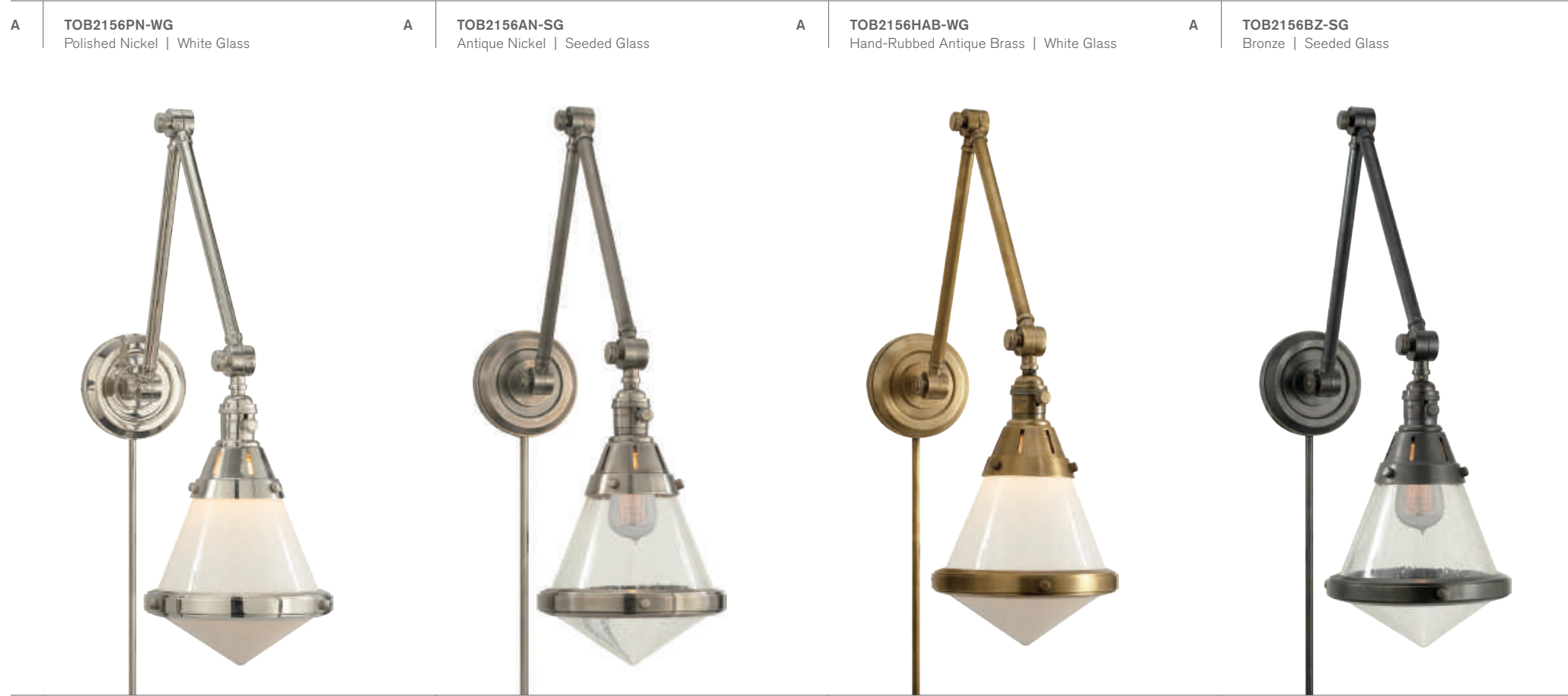

**A** **TOB2156PN-WG**  
Polished Nickel | White Glass

**A** **TOB2156AN-SG**  
Antique Nickel | Seeded Glass

**A** **TOB2156HAB-WG**  
Hand-Rubbed Antique Brass | White Glass

**A** **TOB2156BZ-SG**  
Bronze | Seeded Glass



**B** **TOB2090PN-WG**  
Polished Nickel | White Glass

**B** **TOB2090AN-WG**  
Antique Nickel | White Glass

**B** **TOB2090HAB-WG**  
Hand-Rubbed Antique Brass | White Glass

**B** **TOB2090BZ/HAB-WG**  
Bronze | Hand-Rubbed Antique Brass | White Glass

**A** **GALE LIBRARY SCONCE**  
THOMAS O'BRIEN

**TOB2156**  
H: 21.5" | W: 7.5" | Ext: 17" - 30"  
Backplate: 4.75" Round  
Socket: E26 On-Off | Bulb: 60 A  
**Additional Options:**  
Antique Nickel | White Glass (AN-WG)  
Bronze | White Glass (BZ-WG)  
Hand-Rubbed Antique Brass | Seeded Glass (HAB-SG)  
Polished Nickel | Seeded Glass (PN-SG)

**B** **HICKS LIBRARY LIGHT**  
THOMAS O'BRIEN

**TOB2090**  
H: 17.75" | W: 7.5" | Ext: 16.75" - 30"  
Backplate: 4.75" Round  
Socket: E26 Keyless | Bulb: 60 A



**B** **TOB2090BZ/HAB-WG**  
Bronze | Hand-Rubbed Antique Brass | White Glass

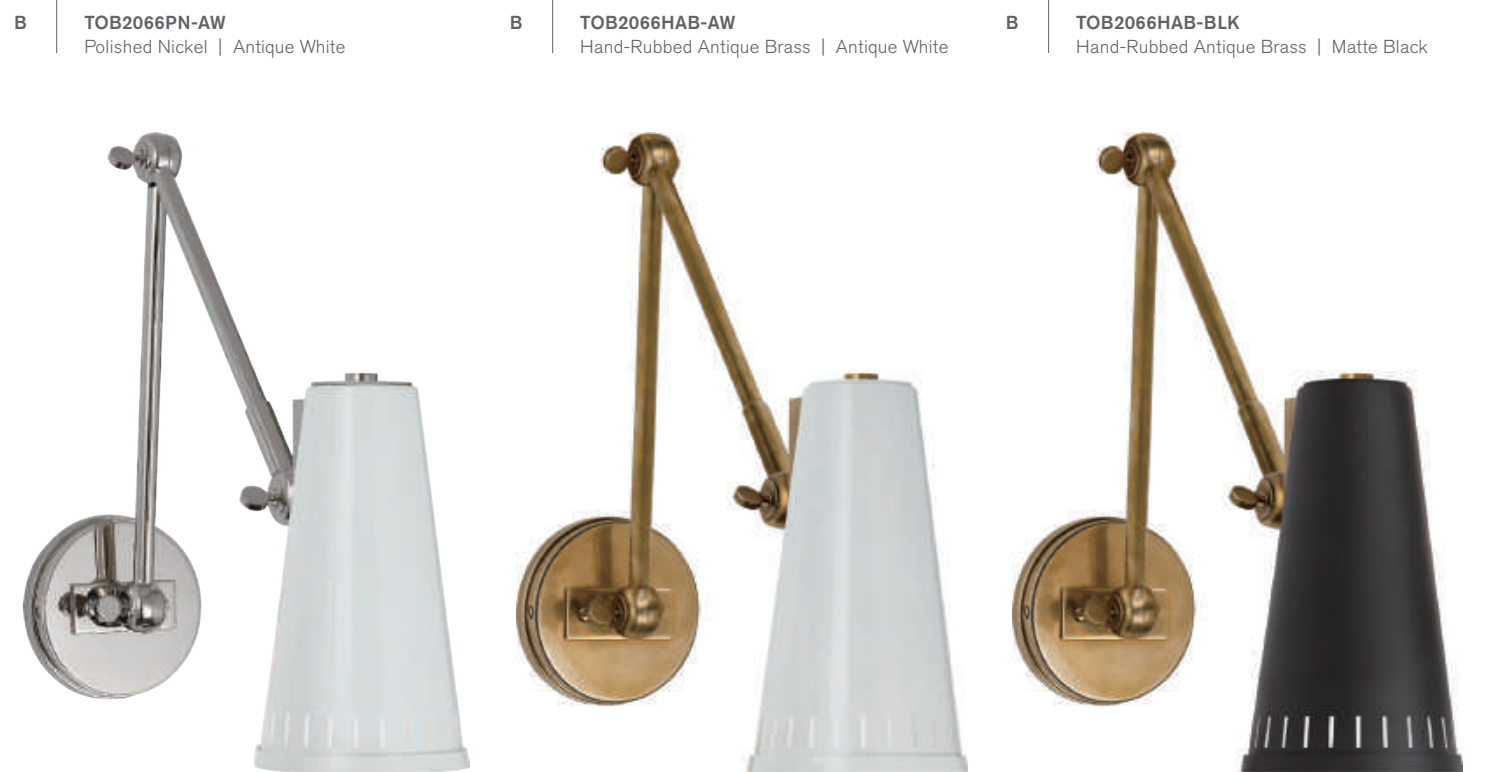
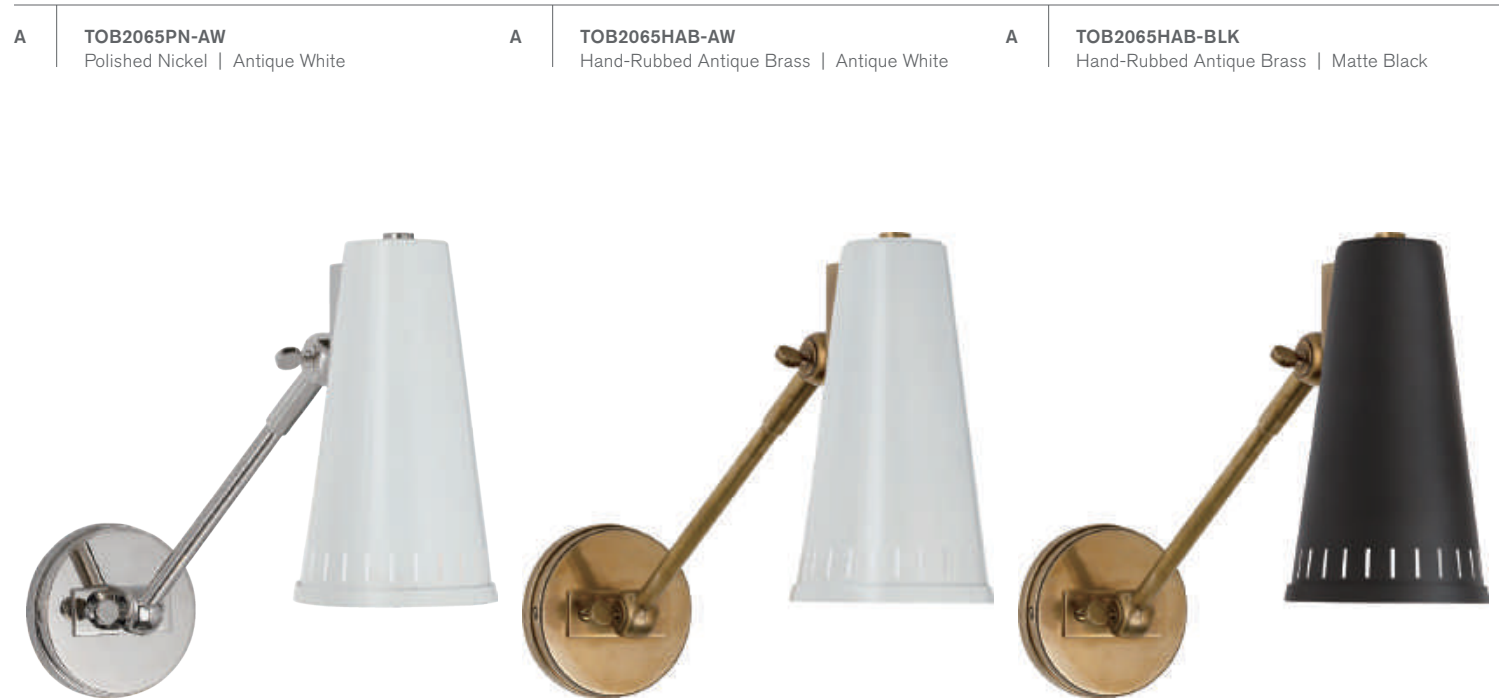

**A ANTONIO SINGLE SCENCE**  
THOMAS O'BRIEN  
**TOB2065**  
H: 8.25" | W: 4.5" | Ext: 7" - 17.75"  
Backplate: 4.5" Round  
Socket: E26 Keyless | Bulb: 60 A

**B ANTONIO DOUBLE SCENCE**  
THOMAS O'BRIEN  
**TOB2066**  
H: 8.25" | W: 4.5" | Ext: 13" - 30.5"  
Backplate: 4.5" Round  
Socket: E26 Keyless | Bulb: 60 A

opposite page  
**C LIAM SMALL ARTICULATING SCENCE**  
STUDIO VC  
**S2640**  
H: 11" | W: 7" | Ext: 10.5"  
Backplate: 4.75" Round  
Socket: E12 Candelabra | Bulb: 40 B  
**Additional Options:**  
Polished Nickel | Metallic Black (PN-MTB)

**B TOB2066PN-AW**  
Polished Nickel | Antique White

**C S2640PN-WHT**  
Polished Nickel | Matte White

**C S2640HAB-WHT**  
Hand-Rubbed Antique Brass | Matte White



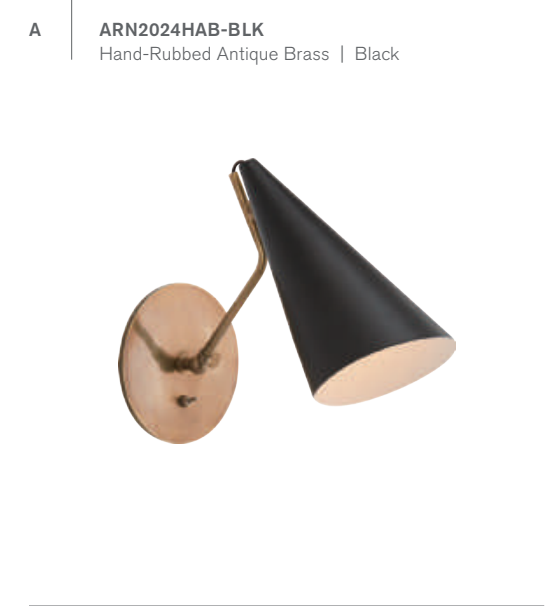
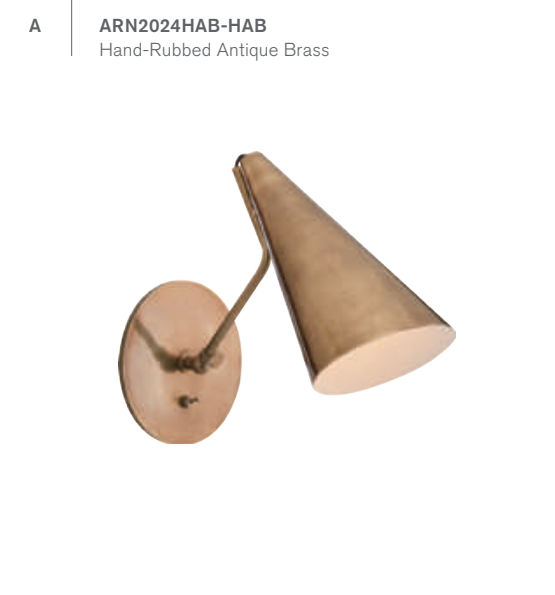
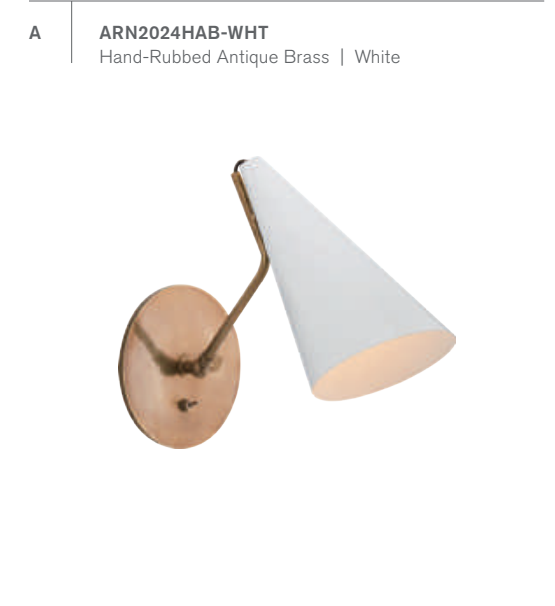

**A** | **CLEMENTE ARTICULATING SCONCE**  
AERIN

**ARN2024**  
H: 10.5" | W: 6.25" | Ext: 13"  
Backplate: 6.25" Round  
Socket: E26 Keyless | Bulb: 60 B

**B** | **CLEMENTE DOUBLE SCONCE**  
AERIN

**ARN2059**  
H: 10.75" | W: 16.75" | Ext: 11.75"  
Backplate: 5" Round  
Socket: 2 - E26 Keyless | Bulb: 2 - 40 B

**C** | **CLEMENTE DOUBLE ARM LIBRARY SCONCE**  
AERIN

**ARN2912**  
H: 20" - 35.5" | W: 6.5" | Ext: 13" - 35"  
Backplate: 6.25" Round  
Socket: E26 Keyless | Bulb: 40 A



A **ARN2006BLK**  
Hand-Rubbed Antique Brass | Matte Black

A **ARN2006WHT**  
Hand-Rubbed Antique Brass | Matte White



A **ARN2006HAB**  
Hand-Rubbed Antique Brass



A **ARN2006BLK**  
Hand-Rubbed Antique Brass | Matte Black



B **ARN2071WHT**  
White



B **ARN2071HAB**  
Hand-Rubbed Antique Brass



C **ARN2072BLK**  
Black



A **CHARLTON ARTICULATING SCNCE**  
AERIN

**ARN2006**  
H: 7.5" - 14.5" | W: 9.25" | Ext: 18"  
Backplate: 5.25" Round  
Socket: E26 Keyless | Bulb: 60 B  
\* Toggle on Backplate

B **CHARLTON MEDIUM DOUBLE WALL LIGHT**  
AERIN

**ARN2071**  
H: 14.5" | W: 48" | Ext: 9.25" - 27.5"  
Backplate: 5.25" Round  
Socket: 2 - E26 On/Off | Bulb: 2 - 40 A  
**Additional Options:**  
Black (BLK)

C **CHARLTON LARGE DOUBLE WALL LIGHT**  
AERIN

**ARN2072**  
H: 20.5" | W: 85" | Ext: 9.256" - 52"  
Backplate: 5.25" Round  
Socket: 2 - E26 On/Off | Bulb: 2 - 40 A  
**Additional Options:**  
Hand-Rubbed Antique Brass (HAB)  
White (WHT)

**A** **TOB2097AN/BZ**  
Antique Nickel | Bronze

**A** **TOB2097HAB**  
Hand-Rubbed Antique Brass

**A** **TOB2097HAB/WHT**  
Hand-Rubbed Antique Brass | White



**A** **ANDERS SMALL ARTICULATING WALL LIGHT**  
THOMAS O'BRIEN

**TOB2097**  
H: 10.75" | W: 5.25" | Ext: 8.75"  
Backplate: 5.25" Round  
Socket: E17 On-Off | Bulb: 40 R14

**B** **LANCELOT PIVOTING LIGHT**  
AERIN

**ARN2042**  
H: 7.5" | W: 6.25" | Ext: 7.25"  
Backplate: 6.25" Round  
Socket: E17 Keyless | Bulb: 4.5 LED R14  
Shade: 6.5" x 7.25" x 8.75"

**C** **LUCIEN FUNCTIONAL WALL LIGHT**  
KELLY WEARSTLER

**KW2420**  
H: 15.25" | W: 5" | Ext: 6.5"  
Backplate: 5" Round  
Socket: E26 Keyless | Bulb: 25 T

**B** **ARN2042PN**  
Polished Nickel

**B** **ARN2042HAB**  
Hand-Rubbed Antique Brass

**C** **KW2420PN**  
Polished Nickel

**C** **KW2420AB**  
Antique-Burnished Brass



**D** **KW2410BZ/AB-WHT**  
Bronze | Brass | White



**D** **KW2410BZ/AB-BLK**  
Bronze | Brass | Black



**D** **CLEO SCONCE**  
KELLY WEARSTLER

**KW2410**  
H: 14" | W: 7" | Ext: 8"  
Backplate: 4.25" x 14" Rec.  
Socket: E26 Keyless | Bulb: 40 G  
\*Requires Smaller Outlet Box

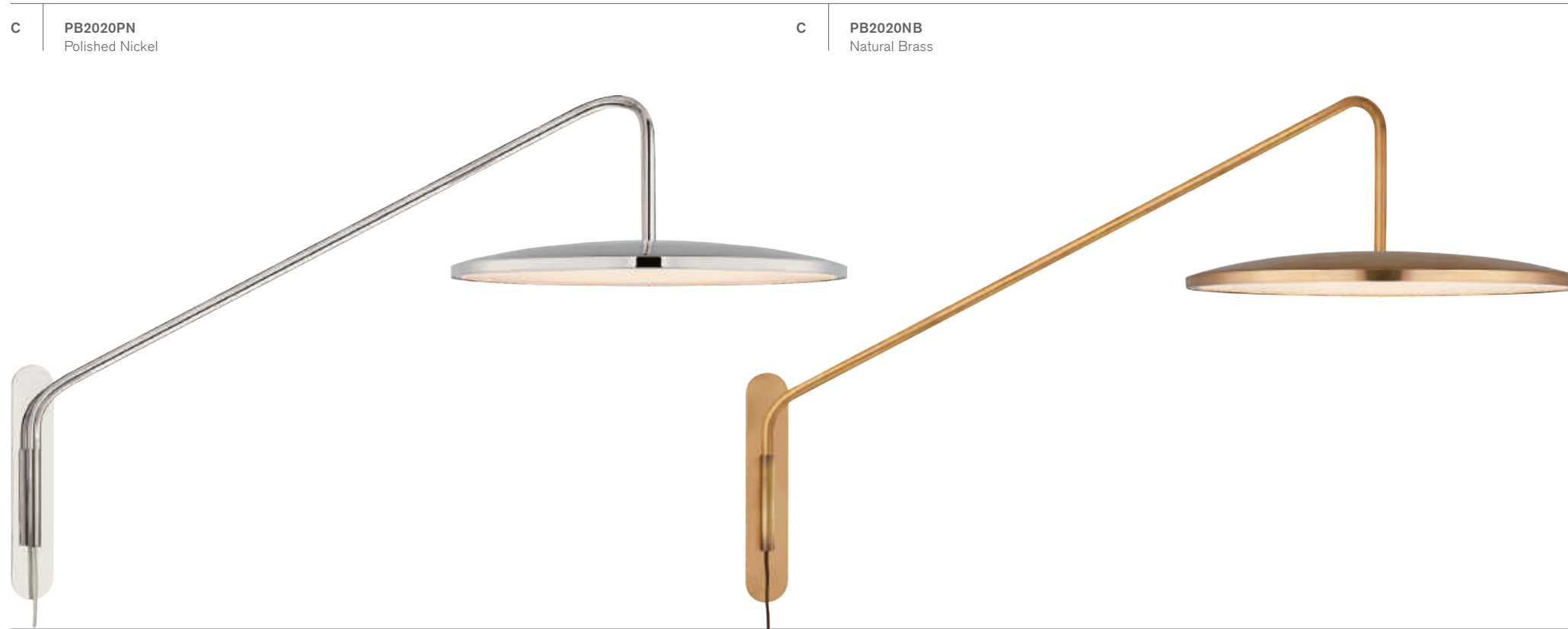

**A** | **DOT 13" CAGED WALL SCONCE**  
PETER BRISTOL

**PB2003**  
H: 6.25" | W: 13.5" | Ext: 15"  
Backplate: 5" Square  
LED: 18w

**B** | **DOT 13" WALL SCONCE**  
PETER BRISTOL

**PB2000**  
H: 6.25" | W: 13.5" | Ext: 15"  
Backplate: 5" Square  
LED: 18w

**C** | **DOT 16" ARTICULATING WALL LIGHT**  
PETER BRISTOL

**PB2020**  
H: 28" | W: 16.25" | Ext: 50.75"  
Backplate: 2.5" x 13.25" Oval  
LED: 24w

**C** | **PB2020MBK**  
Matte Black





WALL | PICTURE



C | SP2603HAB  
Hand-Rubbed Antique Brass



**A** | **MCCLAIN 12" PICTURE LIGHT**  
J. RANDALL POWERS

**SP2600**  
H: 4.5" | W: 12" | Ext: 8.25"  
Backplate: 3" x 4.75" Rec.  
Socket: 2 - E12 Candelabra | Bulb: 2 - 25 T  
**Additional Options:**  
Bronze (BZ)  
\* Requires Smaller Outlet Box

**B** | **MCCLAIN 18" PICTURE LIGHT**  
J. RANDALL POWERS

**SP2601**  
H: 4.5" | W: 18" | Ext: 8.25"  
Backplate: 3" x 4.75" Rec.  
Socket: 2 - E12 Candelabra | Bulb: 2 - 25 T  
**Additional Options:**  
Hand-Rubbed Antique Brass (HAB)  
Polished Nickel (PN)  
\* Requires Smaller Outlet Box

**C** | **MCCLAIN 30" PICTURE LIGHT**  
J. RANDALL POWERS

**SP2603**  
H: 4.5" | W: 30" | Ext: 8.25"  
Backplate: 3" x 4.75" Rec.  
Socket: 4 - E12 Candelabra | Bulb: 4 - 25 T  
**Additional Options:**  
Bronze (BZ)  
\* Requires Smaller Outlet Box

**D** | **MCCLAIN 42" PICTURE LIGHT**  
J. RANDALL POWERS

**SP2605**  
H: 4.5" | W: 42" | Ext: 8.25"  
Backplate: 3" x 4.75" Rec.  
Socket: 4 - E12 Candelabra | Bulb: 4 - 25 T  
**Additional Options:**  
Polished Nickel (PN)  
\* Requires Smaller Outlet Box

**A** | **SP2600PN**  
Polished Nickel



**A** | **SP2600HAB**  
Hand-Rubbed Antique Brass



**B** | **SP2601BZ**  
Bronze



**C** | **SP2603PN**  
Polished Nickel



**C** | **SP2603HAB**  
Hand-Rubbed Antique Brass



**D** | **SP2605HAB**  
Hand-Rubbed Antique Brass



**D** | **SP2605BZ**  
Bronze



**A DORCHESTER 8" PICTURE LIGHT**  
E. F. CHAPMAN

**CHD5117**  
H: 4.5" | W: 8" | Ext: 9.5"  
Backplate: 2.5" x 4.5" Rec.  
Socket: E26 Keyless | Bulb: 40 T  
\* Portable/Switch on Cord 12" From Fixture  
©EFC DESIGNS

**A CHD5117PN**  
Polished Nickel



**A CHD5117AN**  
Antique Nickel



**A CHD5117AB**  
Antique-Burnished Brass



**A CHD5117BZ**  
Bronze



**B DORCHESTER 18" PICTURE LIGHT**  
E. F. CHAPMAN

**CHD5137**  
H: 4.5" | W: 18" | Ext: 9.5"  
Backplate: 4.5" x 14.5" Rec.  
Socket: E26 Keyless | Bulb: 2 - 40 T  
**Additional Options:**  
Antique Nickel (AN)  
\* Portable/Switch on Cord 12" from Fixture  
©EFC DESIGNS

**B CHD5137PN**  
Polished Nickel



**B CHD5137AB**  
Antique-Burnished Brass

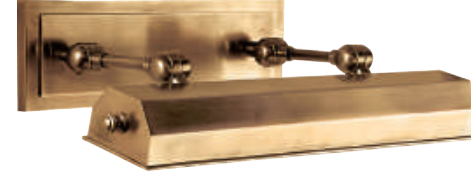

**B CHD5137BZ**  
Bronze



**C DORCHESTER 24" PICTURE LIGHT**  
E. F. CHAPMAN

**CHD5147**  
H: 4.5" | W: 24" | Ext: 9.5"  
Backplate: 4.5" x 18.5" Rec.  
Socket: E26 Keyless | Bulb: 2 - 40 T  
**Additional Options:**  
Bronze (BZ)  
Polished Nickel (PN)  
\* Portable/Switch on Cord 12" from Fixture  
©EFC DESIGNS

**C CHD5147AB**  
Antique-Burnished Brass



**C CHD5147AN**  
Antique Nickel

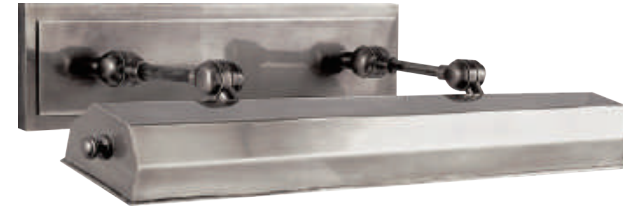

**D DORCHESTER 30" PICTURE LIGHT**  
E. F. CHAPMAN

**CHD5148**  
H: 4.5" | W: 30" | Ext: 9.5"  
Backplate: 4.5" x 22" Rec.  
Socket: E26 Keyless | Bulb: 4 - 25 T  
**Additional Options:**  
Antique-Burnished Brass (AB)  
Antique Nickel (AN)  
Polished Nickel (PN)  
\* Portable/Switch on Cord 12" from Fixture  
©EFC DESIGNS

**D CHD5148BZ**  
Bronze

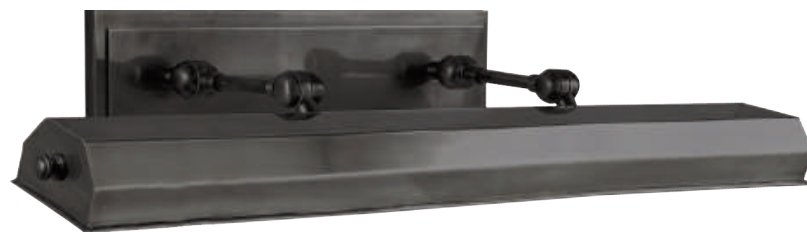

**E LIBRARY 10" PICTURE LIGHT**  
THOMAS O'BRIEN

**TOB2604**  
H: 4" | W: 10.75" | Ext: 5"  
Backplate: 2.75" x 10.75" Rec.  
Socket: E26 Keyless | Bulb: 40 T  
\* Requires Smaller Outlet Box

**E TOB2604PN**  
Polished Nickel



**E TOB2604HAB**  
Hand-Rubbed Antique Brass



**E TOB2604BZ**  
Bronze



**F LIBRARY 16" PICTURE LIGHT**  
THOMAS O'BRIEN

**TOB2605**  
H: 4" | W: 17.5" | Ext: 5"  
Backplate: 2.75" x 17" Rec.  
Socket: 2 - E26 Keyless | Bulb: 2 - 40 T  
**Additional Options:**  
Polished Nickel (PN)  
\* Requires Smaller Outlet Box

**F TOB2605HAB**  
Hand-Rubbed Antique Brass



**F TOB2605BZ**  
Bronze



**G LIBRARY 22" PICTURE LIGHT**  
THOMAS O'BRIEN

**TOB2606**  
H: 4" | W: 23.5" | Ext: 5"  
Backplate: 2.75" x 23" Rec.  
Socket: 2 - E26 Keyless | Bulb: 2 - 40 T  
**Additional Options:**  
Bronze (BZ)  
Hand-Rubbed Antique Brass (HAB)  
\* Requires Smaller Outlet Box

**G TOB2606PN**  
Polished Nickel



B AH2701GM  
Gun Metal



A DEAN 9" PICTURE LIGHT  
ALEXA HAMPTON

AH2700  
H: 5" | W: 10.5" | Ext: 10"  
Backplate: 2.75" x 4.5" Rec.  
Socket: E26 Keyless | Bulb: 40 T  
\* Portable/Switch on Cord

B DEAN 12" PICTURE LIGHT  
ALEXA HAMPTON

AH2701  
H: 5" | W: 13.5" | Ext: 10"  
Backplate: 2.75" x 4.5" Rec.  
Socket: E26 Keyless | Bulb: 40 T  
\* Portable/Switch on Cord

C DEAN 18" PICTURE LIGHT  
ALEXA HAMPTON

AH2702  
H: 5" | W: 19.5" | Ext: 10"  
Backplate: 2.75" x 12" Rec.  
Socket: E26 Keyless | Bulb: 2 - 40 T  
**Additional Options:**  
Brushed Nickel (BN)  
Polished Nickel (PN)  
\* Portable/Switch on Cord

D DEAN 24" PICTURE LIGHT  
ALEXA HAMPTON

AH2703  
H: 5" | W: 25.5" | Ext: 10"  
Backplate: 2.75" x 18" Rec.  
Socket: E26 Keyless | Bulb: 2 - 40 T  
**Additional Options:**  
Brushed Nickel (BN)  
Gun Metal (GM)  
Polished Nickel (PN)  
\* Portable/Switch on Cord

A AH2700PN  
Polished Nickel



A AH2700BN  
Brushed Nickel



A AH2700NB  
Natural Brass



A AH2700GM  
Gun Metal



B AH2701PN  
Polished Nickel

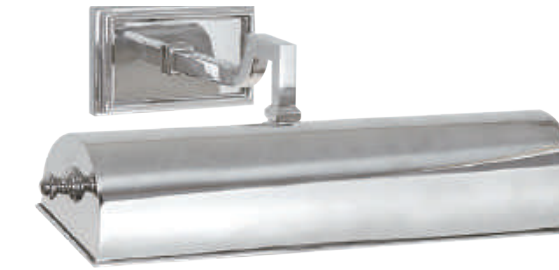

B AH2701BN  
Brushed Nickel



B AH2701NB  
Natural Brass



C AH2702NB  
Natural Brass



C AH2702GM  
Gun Metal



D AH2703NB  
Natural Brass

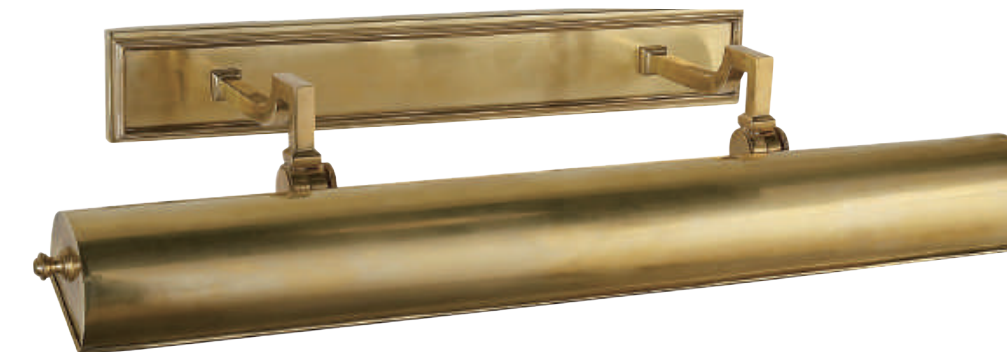

**A 8" CABINET MAKER'S PICTURE LIGHT**  
E. F. CHAPMAN

**SL2704**  
H: 3.5" | W: 8" | Ext: 8.25"  
Backplate: 2.75" x 4.5" Rec.  
Socket: E26 Keyless | Bulb: 25 T  
\* Requires Smaller Outlet Box  
\* Line Switch  
©EFC DESIGNS



**B 18" CABINET MAKER'S PICTURE LIGHT**  
E. F. CHAPMAN

**SL2705**  
H: 3.5" | W: 18" | Ext: 8.25"  
Backplate: 2.75" x 4.5" Rec.  
Socket: 2 - E26 Keyless | Bulb: 2 - 25 T  
**Additional Options:**  
Antique Nickel (AN)  
\* Requires Smaller Outlet Box  
\* Line Switch  
©EFC DESIGNS



**C 24" CABINET MAKER'S PICTURE LIGHT**  
E. F. CHAPMAN

**SL2706**  
H: 3.5" | W: 24" | Ext: 8.25"  
Backplate: 2.75" x 4.5" Rec.  
Socket: 2 - E26 Keyless | Bulb: 2 - 25 T  
**Additional Options:**  
Bronze (BZ)  
Polished Nickel (PN)  
\* Requires Smaller Outlet Box  
\* Line Switch  
©EFC DESIGNS

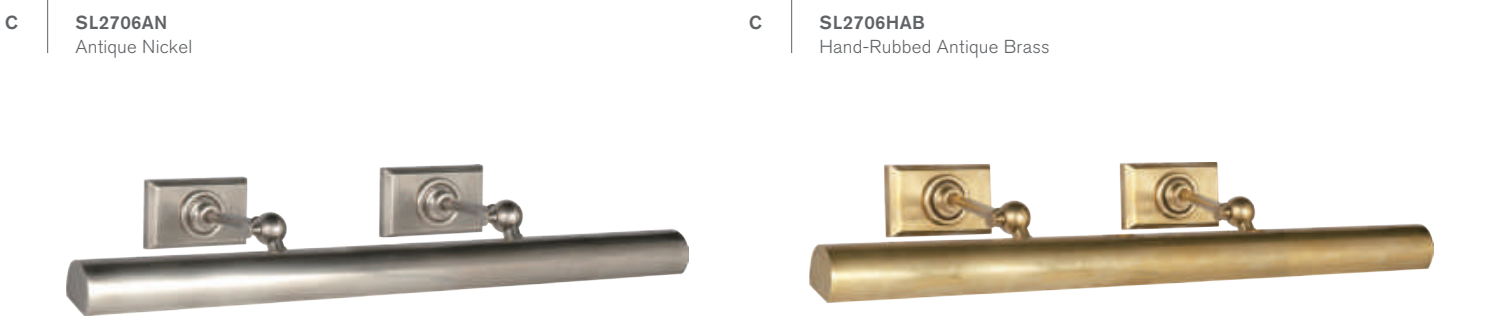

**D 30" CABINET MAKER'S PICTURE LIGHT**  
E. F. CHAPMAN

**SL2707**  
H: 3.5" | W: 30" | Ext: 8.25"  
Backplate: 2.75" x 4.5" Rec.  
Socket: 4 - E26 Keyless | Bulb: 4 - 25 T  
**Additional Options:**  
Antique Nickel (AN)  
Hand-Rubbed Antique Brass (HAB)  
Polished Nickel (PN)  
\* Requires Smaller Outlet Box  
©EFC DESIGNS

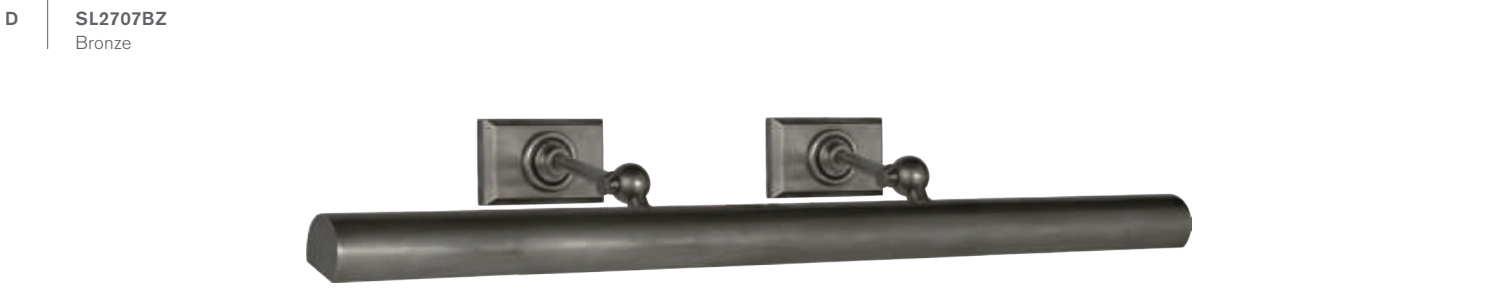

**E FRAME MAKERS 8" PICTURE LIGHT**  
E. F. CHAPMAN

**SL2701**  
H: 1.5" | W: 8" | Ext: 9"  
Socket: E26 Keyless | Bulb: 25 T  
\* Portable/Line Switch on Cord 12" from Arm  
\* Cannot be Hard-Wired  
©EFC DESIGNS



**F FRAME MAKERS 18" PICTURE LIGHT**  
E. F. CHAPMAN

**SL2702**  
H: 1.5" | W: 18" | Ext: 9"  
Socket: 2 - E26 Keyless | Bulb: 2 - 25 T  
**Additional Options:**  
Antique Nickel (AN)  
\* Portable/Line Switch on Cord 12" from Arm  
\* Cannot be Hard-Wired  
©EFC DESIGNS



**G FRAME MAKERS 24" PICTURE LIGHT**  
E. F. CHAPMAN

**SL2703**  
H: 1.5" | W: 24" | Ext: 9"  
Socket: 2 - E26 Keyless | Bulb: 2 - 25 T  
**Additional Options:**  
Bronze (BZ)  
Polished Nickel (PN)  
\* Portable/Line Switch on Cord 12" from Arm  
\* Cannot be Hard-Wired  
©EFC DESIGNS

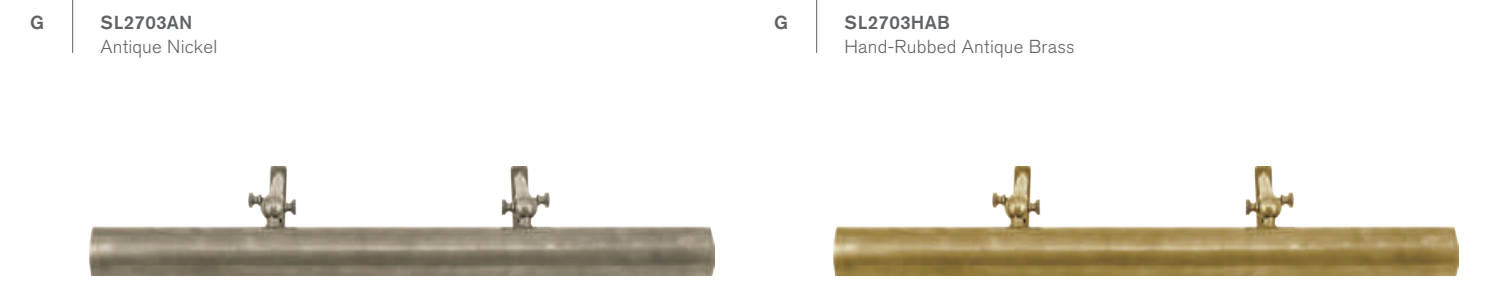

**H FRAME MAKERS 30" PICTURE LIGHT**  
E. F. CHAPMAN

**SL2708**  
H: 1.5" | W: 30" | Ext: 9"  
Socket: 4 - E26 Keyless | Bulb: 4 - 25 T  
**Additional Options:**  
Antique Nickel (AN)  
Hand-Rubbed Antique Brass (HAB)  
Polished Nickel (PN)  
\* Portable/Line Switch on Cord 12" from Arm  
\* Cannot be Hard-Wired  
©EFC DESIGNS



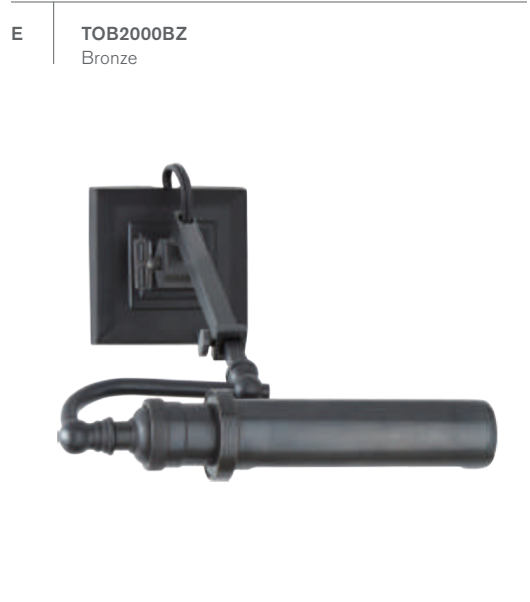
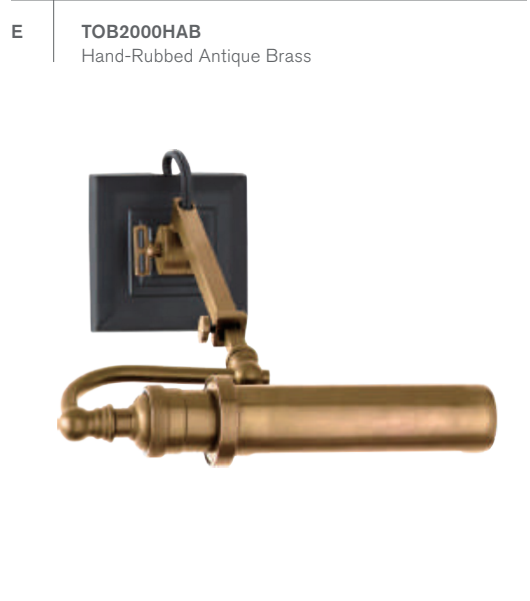
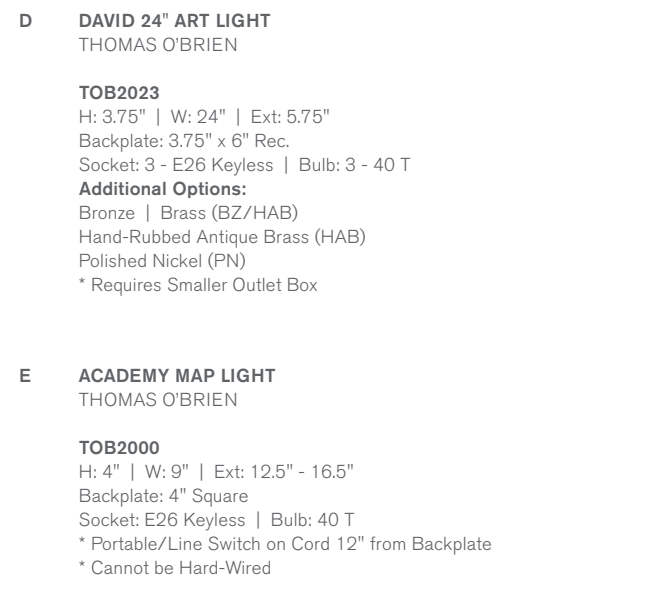



opposite page

**A COSMOPOLITAN 10" PICTURE LIGHT**  
THOMAS O'BRIEN

**TOB2620**  
H: 9.75" | W: 10" | Ext: 11.25"  
Backplate: 4" x 5.5" Rec.  
Socket: E26 Keyless | Bulb: 40 T

**B COSMOPOLITAN 18" PICTURE LIGHT**  
THOMAS O'BRIEN

**TOB2621**  
H: 9.75" | W: 18" | Ext: 11.25"  
Backplate: 4" x 5.5" Rec.  
Socket: 2 - E26 Keyless | Bulb: 2 - 25 T

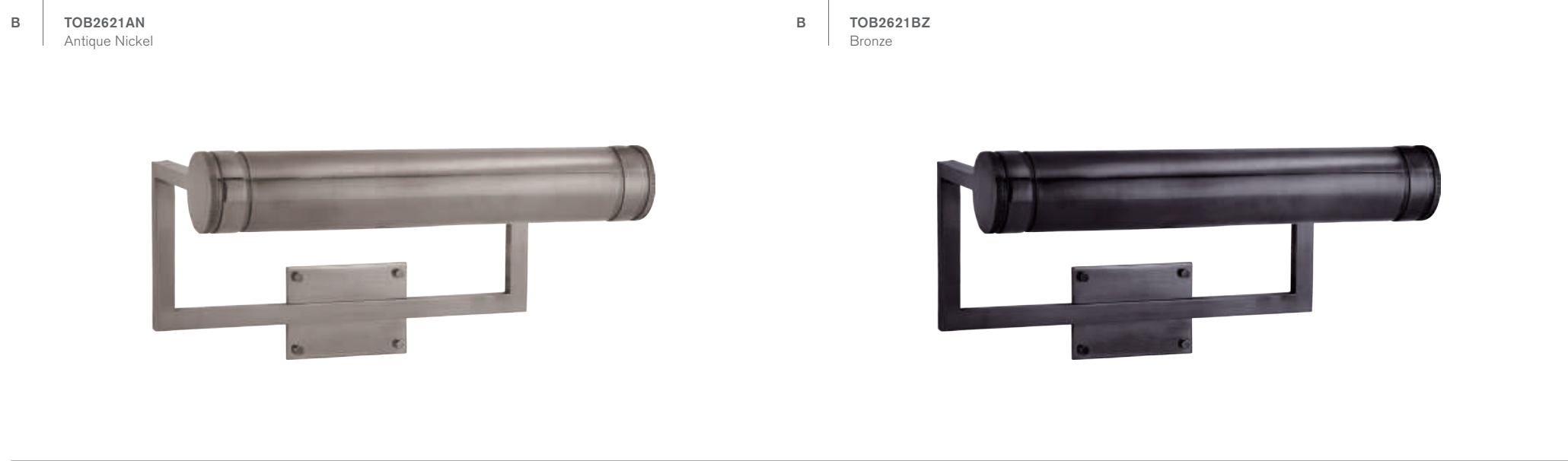
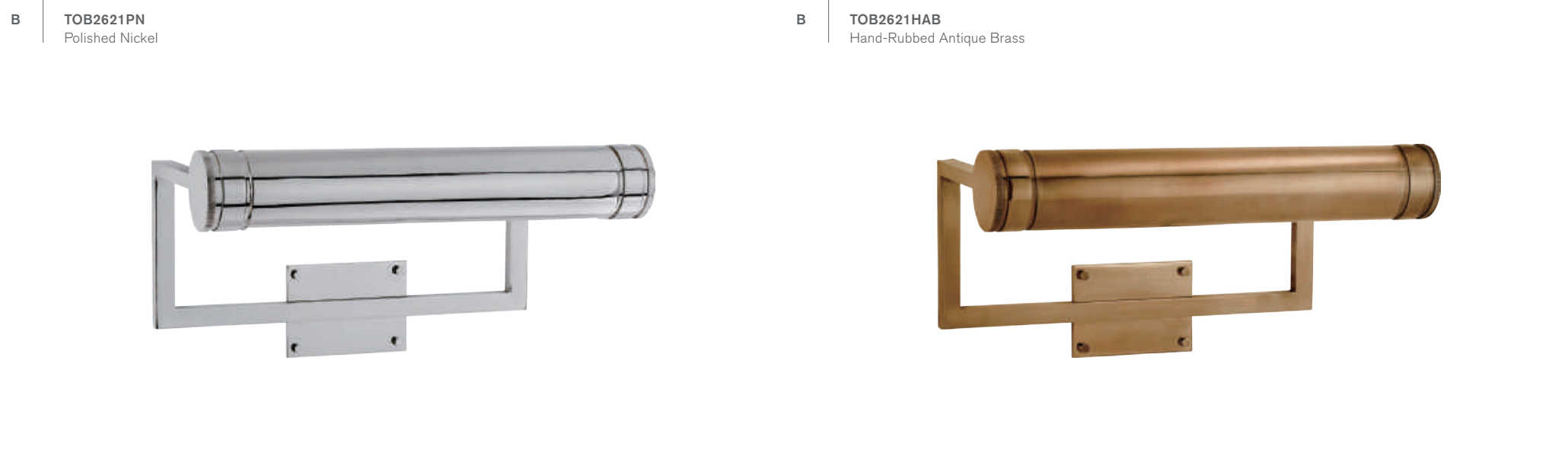

**C COSMOPOLITAN 30" PICTURE LIGHT**  
THOMAS O'BRIEN

**TOB2623**  
H: 9.75" | W: 30" | Ext: 11.25"  
Backplate: 4" x 5.5" Rec.  
Socket: 3 - E26 Keyless | Bulb: 3 - 25 T  
**Additional Options:**  
Antique Nickel (AN)



WALL | BATH



**A** | **KW2048PN-WG**  
Polished Nickel | White Glass

**A** | **UTOPIA LARGE DOUBLE SCONCE**  
KELLY WEARSTLER

**KW2048**  
H: 23" | W: 4.75" | Ext: 5"  
Backplate: 4.75" x 9.25"  
Socket: 2 - E26 Keyless | Bulb: 2 - 60 T  
**Additional Options:**  
Aged Iron | White Glass (AI-WG)  
Gild | White Glass (G-WG)

opposite page

**B** | **UTOPIA SMALL SINGLE SCONCE**  
KELLY WEARSTLER

**KW2043**  
H: 14" | W: 4.75" | Ext: 5"  
Backplate: 4.75" x 7"  
Socket: E26 Keyless | Bulb: 60 B  
**Additional Options:**  
Polished Nickel | White Glass (PN-WG)

**C** | **UTOPIA SMALL DOUBLE SCONCE**  
KELLY WEARSTLER

**KW2047**  
H: 18" | W: 4.5" | Ext: 5"  
Backplate: 4.5" x 7.5"  
Socket: 2 - E26 Keyless | Bulb: 2 - 60 B  
**Additional Options:**  
Polished Nickel | White Glass (PN-WG)

**D** | **UTOPIA LARGE BAND SCONCE**  
KELLY WEARSTLER

**KW2033**  
H: 14" | W: 3" | Ext: 4"  
Backplate: 3" x 8" Oval  
Socket: 2 - E12 Candelabra | Bulb: 2 - 60 B  
**Additional Options:**  
Polished Nickel | White Glass (PN-WG)  
\* Requires Smaller Outlet Box

**E** | **UTOPIA LINEAR SCONCE**  
KELLY WEARSTLER

**KW2057**  
H: 16" | W: 5.25" | Ext: 4"  
Backplate: 3.75" x 14.5" Rec.  
Socket: 2 - E12 Candelabra | Bulb: 2 - 40 B  
\* Requires Smaller Outlet Box

**B** | **KW2043G-WG**  
Gild | White Glass



**B** | **KW2043AI-WG**  
Aged Iron | White Glass



**C** | **KW2047G-WG**  
Gild | White Glass



**C** | **KW2047AI-WG**  
Aged Iron | White Glass



**D** | **KW2033G-WG**  
Gild | White Glass



**D** | **KW2033AI-WG**  
Aged Iron | White Glass



**E** | **KW2057G-FR**  
Gild | Fractured Glass



**E** | **KW2057AI-FR**  
Aged Iron | Fractured Glass





**A** | **KW2116PN-ALB**  
Polished Nickel | Alabaster



**A** | **KW2116AB-ALB**  
Antique-Burnished Brass | Alabaster



**B** | **KW2112BZ-ALB**  
Bronze | Alabaster

opposite page

**A** | **COVET DOUBLE BOX SCONCE**  
KELLY WEARSTLER

**KW2116**  
H: 26" | W: 4.25" | Ext: 4"  
Backplate: 4.25" x 6.5" Rec.  
LED: 19w  
**Additional Options:**  
Bronze | Alabaster (BZ-ALB)

**B** | **COVET TALL BOX SCONCE**  
KELLY WEARSTLER

**KW2112**  
H: 16" | W: 4.25" | Ext: 4.5"  
Backplate: 4.25" Square  
Socket: E26 Keyless | Bulb: 12 LED T  
**Additional Options:**  
Antique-Burnished Brass | Alabaster (AB-ALB)  
Polished Nickel | Alabaster (PN-ALB)  
\* Requires Smaller Outlet Box

**C** | **COVET SHORT CLIP SCONCE**  
KELLY WEARSTLER

**KW2113**  
H: 10.75" | W: 5.5" | Ext: 3.5"  
Backplate: 5.5" x 7" Rec.  
Socket: E26 Keyless | Bulb: 12 LED B

**D** | **COVET WIDE CLIP SCONCE**  
KELLY WEARSTLER

**KW2115**  
H: 9.5" | W: 5.25" | Ext: 3.5"  
Backplate: 5.25" x 9.5" Rec.  
Socket: E12 Candelabra | Bulb: 12 LED B

**C** | **KW2113PN-ALB**  
Polished Nickel | Alabaster



**C** | **KW2113AB-ALB**  
Antique-Burnished Brass | Alabaster



**C** | **KW2113BZ-ALB**  
Bronze | Alabaster



**D** | **KW2115PN-ALB**  
Polished Nickel | Alabaster



**D** | **KW2115AB-ALB**  
Antique-Burnished Brass | Alabaster



**D** | **KW2115BZ-ALB**  
Bronze | Alabaster



<b>A</b>	<b>TOB2003CH</b> Chrome   White Glass	<b>A</b>	<b>TOB2003PN</b> Polished Nickel   White Glass	<b>A</b>	<b>TOB2003HAB</b> Hand-Rubbed Antique Brass   White Glass	<b>A</b>	<b>TOB2003BZ</b> Bronze   White Glass
----------	--	----------	---	----------	--	----------	--



**A** **MERCER SHORT BOX LIGHT**  
THOMAS O'BRIEN

**TOB2003**  
H: 9.5" | W: 5.5" | Ext: 4"  
Backplate: 5.5" x 9.5" Rec.  
Socket: E26 Keyless | Bulb: 60 T

**B** **MERCER LONG BOX LIGHT**  
THOMAS O'BRIEN

**TOB2005**  
H: 24" | W: 5.5" | Ext: 4"  
Backplate: 5.5" x 24" Rec.  
Socket: 3 - E26 Keyless | Bulb: 3 - 60 T

<b>C</b>	<b>TOB2004BZ</b> Bronze   White Glass
----------	--

<b>C</b>	<b>TOB2004PN</b> Polished Nickel   White Glass
----------	---



<b>C</b>	<b>TOB2004HAB</b> Hand-Rubbed Antique Brass   White Glass
----------	--



<b>B</b>	<b>TOB2005CH</b> Chrome   White Glass	<b>B</b>	<b>TOB2005PN</b> Polished Nickel   White Glass	<b>B</b>	<b>TOB2005HAB</b> Hand-Rubbed Antique Brass   White Glass	<b>B</b>	<b>TOB2005BZ</b> Bronze   White Glass
----------	--	----------	---	----------	--	----------	--



opposite page

**C** **MERCER SQUARE BOX LIGHT**  
THOMAS O'BRIEN

**TOB2004**  
H: 12" | W: 12" | Ext: 4"  
Backplate: 12" Square  
Socket: 2 - E26 Keyless | Bulb: 2 - 60 T  
**Additional Options:**  
Chrome | White Glass (CH)



**B** TOB2185PN-WG  
Polished Nickel | White Glass



**A** CALLIOPE SHORT SCONCE  
THOMAS O'BRIEN

**TOB2184**  
H: 11.5" | W: 4" | Ext: 4"  
Backplate: 4" x 10.5" Rec.  
Socket: E26 Keyless | Bulb: 60 B

**B** CALLIOPE TALL SCONCE  
THOMAS O'BRIEN

**TOB2185**  
H: 20.5" | W: 4" | Ext: 4"  
Backplate: 3.5" x 19" Rec.  
Socket: 2 - E26 Keyless | Bulb: 2 - 40 T

**C** DRESSER SHORT GLASS ROD SCONCE  
THOMAS O'BRIEN

**TOB2140**  
H: 10.75" | W: 5" | Ext: 3.5"  
Backplate: 5" x 10.75" Rec.  
Socket: E26 Keyless | Bulb: 60 T  
**Additional Options:**  
Antique Nickel | Frosted Glass (AN-FG)

**D** DRESSER LONG GLASS ROD SCONCE  
THOMAS O'BRIEN

**TOB2141**  
H: 18" | W: 5" | Ext: 3.5"  
Backplate: 5" x 18" Rec.  
Socket: 2 - E26 Keyless | Bulb: 2 - 60 T  
**Additional Options:**  
Polished Nickel | Frosted Glass (PN-FG)

<b>A</b> TOB2184PN-WG Polished Nickel   White Glass	<b>A</b> TOB2184HAB-WG Hand-Rubbed Antique Brass   White Glass	<b>A</b> TOB2184BZ-WG Bronze   White Glass	<b>C</b> TOB2140PN-FG Polished Nickel   Frosted Glass	<b>C</b> TOB2140HAB-FG Hand-Rubbed Antique Brass   Frosted Glass	<b>C</b> TOB2140BZ-FG Bronze   Frosted Glass
--	---	---	--	---	---



<b>B</b> TOB2185PN-WG Polished Nickel   White Glass	<b>B</b> TOB2185HAB-WG Hand-Rubbed Antique Brass   White Glass	<b>B</b> TOB2185BZ-WG Bronze   White Glass	<b>D</b> TOB2141AN-FG Antique Nickel   Frosted Glass	<b>D</b> TOB2141HAB-FG Hand-Rubbed Antique Brass   Frosted Glass	<b>D</b> TOB2141BZ-FG Bronze   Frosted Glass
--	---	---	---	---	---



A

**TOB2062PN-WG**  
Polished Nickel | White Glass



A

**TOB2062BZ-WG**  
Bronze | White Glass



A

**TOB2062BZ/HAB-WG**  
Bronze | Brass | White Glass



opposite page

**A SELECTA LONG SCONCE**  
THOMAS O'BRIEN

**TOB2062**  
H: 21.75" | W: 4.75" | Ext: 3.25"  
Backplate: 4.75" x 21.75" Rec.  
Socket: 2 - E26 Keyless | Bulb: 2 - 60 T  
**Additional Options:**  
Chrome | White Glass (CH-WG)

B

**TOB2016PN**  
Polished Nickel | White Glass



B

**TOB2016BZ/HAB**  
Bronze | Brass | White Glass



B

**TOB2016AN**  
Antique Nickel | White Glass



C

**AH2023PN-WG**  
Polished Nickel | White Glass



C

**AH2023NB-WG**  
Natural Brass | White Glass



C

**AH2023GM-WG**  
Gun Metal | White Glass



**B GREENWICH SCONCE**  
THOMAS O'BRIEN

**TOB2016**  
H: 10.5" | W: 4.25" | Ext: 4"  
Backplate: 3" x 8" Rec.  
Socket: E26 Keyless | Bulb: 60 T  
\* Requires Smaller Outlet Box

**C BASIL SMALL LINEAR SCONCE**  
ALEXA HAMPTON

**AH2023**  
H: 16" | W: 5.5" | Ext: 4.25"  
Backplate: 5.5" x 15" Rec.  
Socket: E26 Keyless | Bulb: 40 T

<b>A</b>	<b>SS2011CH-FG</b> Chrome   Frosted Glass	<b>A</b>	<b>SS2011PN-FG</b> Polished Nickel   Frosted Glass	<b>A</b>	<b>SS2011AN-FG</b> Antique Nickel   Frosted Glass	<b>A</b>	<b>SS2011HAB-FG</b> Hand-Rubbed Antique Brass   Frosted Glass	<b>A</b>	<b>SS2011BZ-FG</b> Bronze   Frosted Glass
----------	--	----------	---	----------	--	----------	--	----------	--



**A OPENWORK SINGLE SCONCE**  
STUDIO VC

**SS2011**  
H: 9" | W: 4.75" | Ext: 5"  
Backplate: 4.75" Square  
Socket: E26 Keyless | Bulb: 60 T

<b>B</b>	<b>SS2013CH-FG</b> Chrome   Frosted Glass	<b>B</b>	<b>SS2013PN-FG</b> Polished Nickel   Frosted Glass	<b>B</b>	<b>SS2013AN-FG</b> Antique Nickel   Frosted Glass	<b>B</b>	<b>SS2013HAB-FG</b> Hand-Rubbed Antique Brass   Frosted Glass	<b>B</b>	<b>SS2013BZ-FG</b> Bronze   Frosted Glass
----------	--	----------	---	----------	--	----------	--	----------	--



**B OPENWORK MEDIUM SCONCE**  
STUDIO VC

**SS2013**  
H: 18" | W: 4.75" | Ext: 5"  
Backplate: 4.75" Square  
Socket: 2 - E26 Keyless | Bulb: 2 - 60 T

**C OPENWORK LONG SCONCE**  
STUDIO VC

**SS2014**  
H: 4.75" | W: 24" | Ext: 5"  
Backplate: 4.75" Square  
Socket: 2 - E26 Keyless | Bulb: 2 - 60 T

**Additional Options:**  
Antique Nickel | Frosted Glass (AN-FG)  
Bronze | Frosted Glass (BZ-FG)  
Chrome | Frosted Glass (CH-FG)  
Hand-Rubbed Antique Brass | Frosted Glass (HAB-FG)



**C** **SS2014PN-FG**  
Polished Nickel | Frosted Glass

B

**TOB2031PN-WG**  
Polished Nickel | White Glass



**A** **KEELEY SHORT PIVOTING SCONCE**  
THOMAS O'BRIEN

**TOB2030**  
H: 12" | W: 3.5" | Ext: 6.5"  
Backplate: 3.5" x 5.75"  
Socket: E26 Keyless | Bulb: 60 T  
\* Requires Smaller Outlet Box

A

**TOB2030CH-WG**  
Chrome | White Glass



A

**TOB2030PN-WG**  
Polished Nickel | White Glass



A

**TOB2030HAB-WG**  
Hand-Rubbed Antique Brass | White Glass



A

**TOB2030BZ-WG**  
Bronze | White Glass



**B** **KEELEY TALL PIVOTING SCONCE**  
THOMAS O'BRIEN

**TOB2031**  
H: 20.75" | W: 3.5" | Ext: 6.5"  
Backplate: 3.5" x 20.75" Rec.  
Socket: 2 - E26 Keyless | Bulb: 2 - 60 T  
\* Requires Smaller Outlet Box

B

**TOB2031CH-WG**  
Chrome | White Glass



B

**TOB2031PN-WG**  
Polished Nickel | White Glass



B

**TOB2031HAB-WG**  
Hand-Rubbed Antique Brass | White Glass



B

**TOB2031BZ-WG**  
Bronze | White Glass



<b>A</b>	<b>CHD1550CH-FG</b> Chrome   Frosted Glass	<b>A</b>	<b>CHD1550PN-FG</b> Polished Nickel   Frosted Glass	<b>A</b>	<b>CHD1550AN-FG</b> Antique Nickel   Frosted Glass	<b>A</b>	<b>CHD1550AB-FG</b> Antique-Burnished Brass   Frosted Glass	<b>A</b>	<b>CHD1550BZ-FG</b> Bronze   Frosted Glass
----------	---	----------	--	----------	---	----------	--	----------	---



<b>B</b>	<b>CHD1552CH-FG</b> Chrome   Frosted Glass	<b>B</b>	<b>CHD1552PN-FG</b> Polished Nickel   Frosted Glass	<b>B</b>	<b>CHD1552AN-FG</b> Antique Nickel   Frosted Glass	<b>B</b>	<b>CHD1552AB-FG</b> Antique-Burnished Brass   Frosted Glass	<b>B</b>	<b>CHD1552BZ-FG</b> Bronze   Frosted Glass
----------	---	----------	--	----------	---	----------	--	----------	---



<b>B</b>	<b>CHD1552PN-FG</b> Polished Nickel   Frosted Glass
----------	--



**A** **OXFORD 8" LINEAR SCONCE**  
E. F. CHAPMAN

**CHD1550**  
H: 8.5" | W: 3" | Ext: 4"  
Backplate: 3" x 8.5" Rec.  
Socket: E26 Keyless | Bulb: 60 B  
\* Requires Smaller Outlet Box  
©EFC DESIGNS

**B** **OXFORD 18" LINEAR SCONCE**  
E. F. CHAPMAN

**CHD1552**  
H: 18.5" | W: 4.25" | Ext: 4"  
Backplate: 3.75" x 18"  
Socket: 2 - E26 Keyless | Bulb: 2 - 60 B  
\* Requires Smaller Outlet Box  
©EFC DESIGNS

**B** | **CHD1553PN-FG**  
Polished Nickel | Frosted Glass



**A** | **OXFORD 12" LINEAR SCNCE**  
E. F. CHAPMAN

**CHD1551**  
H: 12" | W: 3.75" | Ext: 4"  
Backplate: 3.75" x 12" Rec.  
Socket: E26 Keyless | Bulb: 60 B  
\* Requires Smaller Outlet Box  
©EFC DESIGNS

**A** | **CHD1551CH-FG**  
Chrome | Frosted Glass



**A** | **CHD1551PN-FG**  
Polished Nickel | Frosted Glass



**A** | **CHD1551AN-FG**  
Antique Nickel | Frosted Glass



**A** | **CHD1551AB-FG**  
Antique-Burnished Brass | Frosted Glass



**A** | **CHD1551BZ-FG**  
Bronze | Frosted Glass

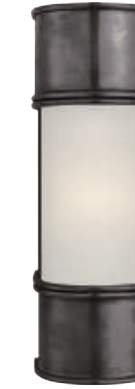

**B** | **OXFORD 24" LINEAR SCNCE**  
E. F. CHAPMAN

**CHD1553**  
H: 24" | W: 4" | Ext: 4" | Backplate: 3.75" x 24"  
Socket: 3 - E26 Keyless | Bulb: 3 - 60 T  
\* Requires Smaller Outlet Box  
©EFC DESIGNS

**B** | **CHD1553CH-FG**  
Chrome | Frosted Glass



**B** | **CHD1553PN-FG**  
Polished Nickel | Frosted Glass



**B** | **CHD1553AN-FG**  
Antique Nickel | Frosted Glass



**B** | **CHD1553AB-FG**  
Antique-Burnished Brass | Frosted Glass



**B** | **CHD1553BZ-FG**  
Bronze | Frosted Glass





A **BBL2090SS-FG**  
Soft Silver | Frosted Glass



A **BBL2090PN-FG**  
Polished Nickel | Frosted Glass



A **URBANE SCONCE**  
BARBARA BARRY

**BBL2090**  
H: 9" | W: 4" | Ext: 5"  
Backplate: 4" Square  
Socket: E26 Keyless | Bulb: 40 B

A **BBL2090PN-FG**  
Polished Nickel | Frosted Glass



A **BBL2090SB-FG**  
Soft Brass | Frosted Glass



A **BBL2090BZ-FG**  
Bronze | Frosted Glass



B **PRECISION TUBE SCONCE**  
KELLY WEARSTLER

**KW2220**  
H: 14" | W: 4" | Ext: 4"  
Backplate: 4" x 11" Rec.  
Socket: 2 - E12 Candelabra | Bulb: 2 - 25 B  
\* Requires Smaller Outlet Box

B **KW2220PN-WG**  
Polished Nickel | White Glass



B **KW2220AB-WG**  
Antique-Burnished Brass | White Glass



B **KW2220BZ-WG**  
Bronze | White Glass



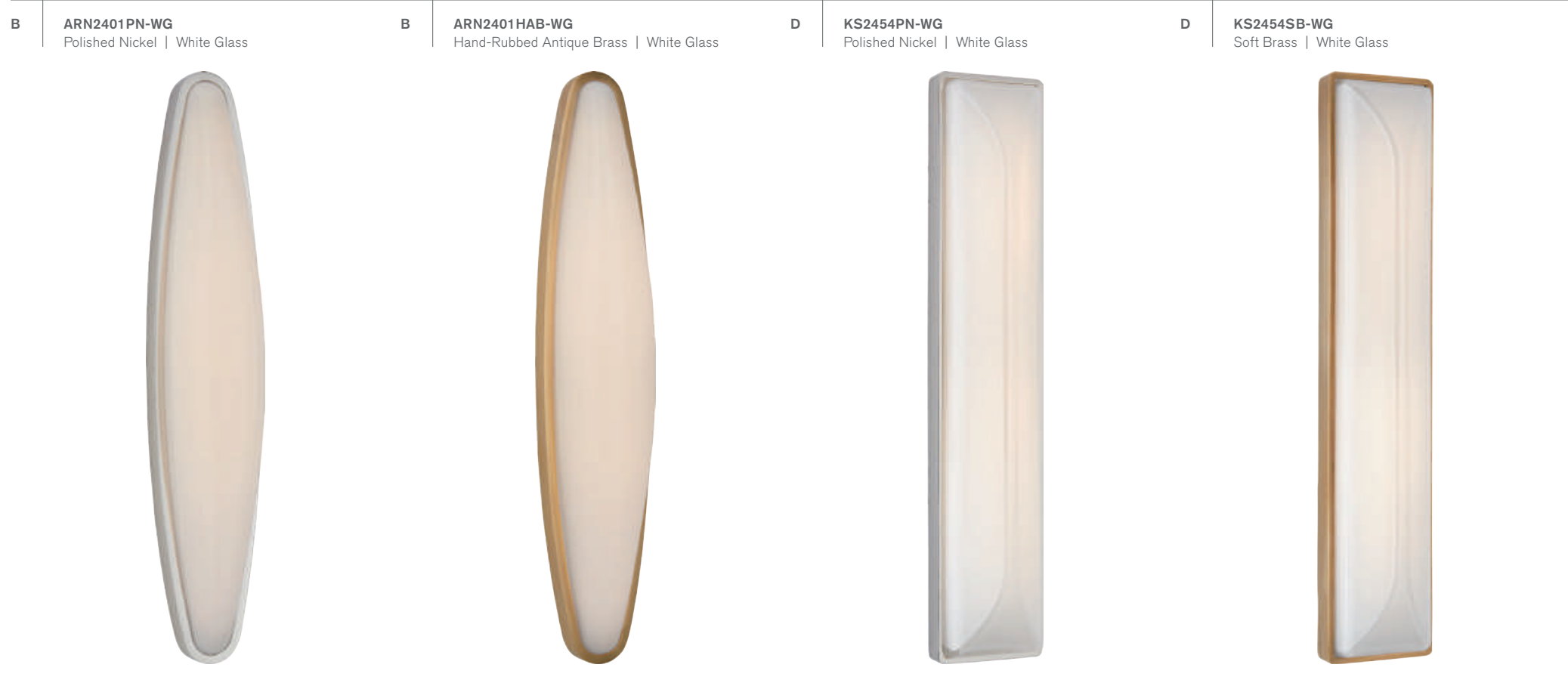
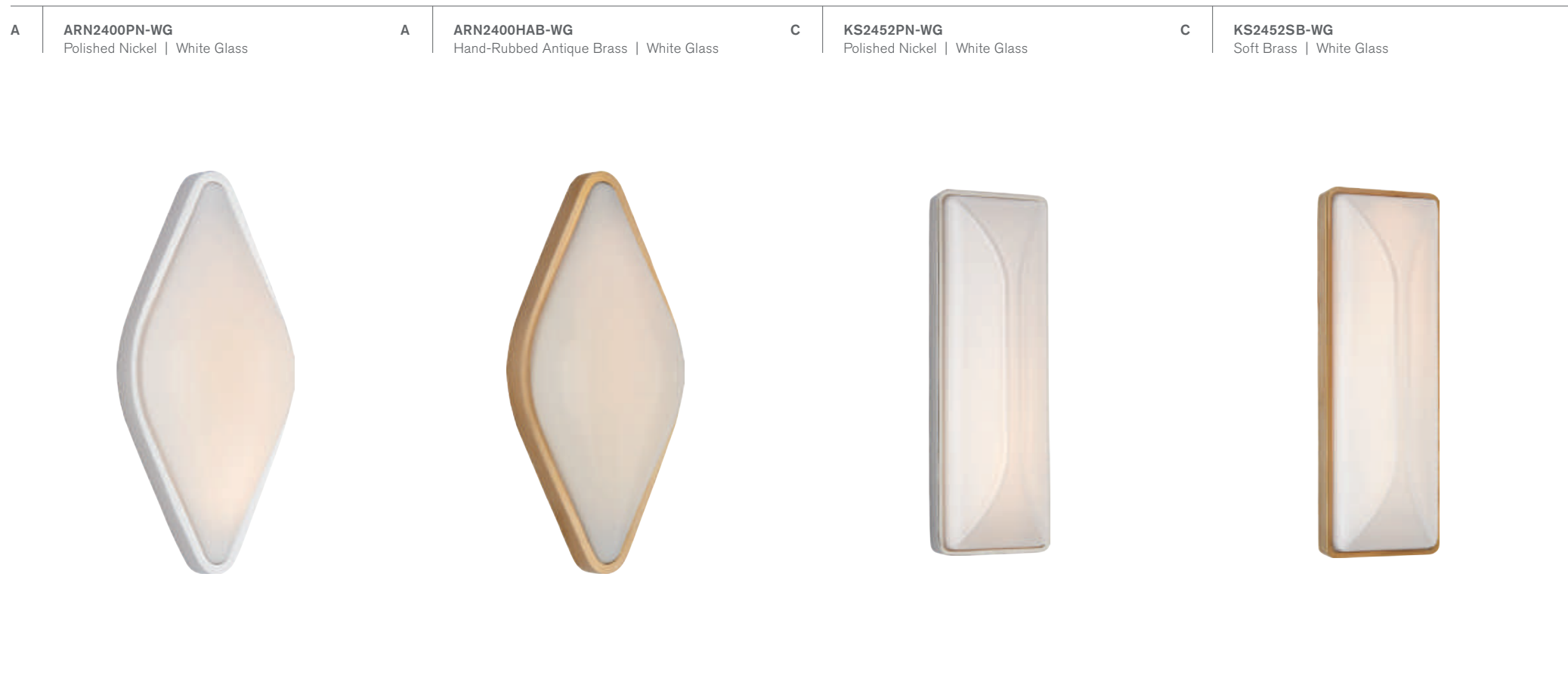

opposite page

**A** | **EZRA MEDIUM BATH SCONCE**  
AERIN

**ARN2400**  
H: 15.25" | W: 7.75" | Ext: 3.75"  
Backplate: 7.75" x 15.25" Oval  
LED: 8w  
**Additional Options:**  
Bronze | White Glass (BZ-WG)

**B** | **EZRA LARGE BATH SCONCE**  
AERIN

**ARN2401**  
H: 24" | W: 4.75" | Ext: 3.25"  
Backplate: 4.75" x 24" Oval  
LED: 16w  
\* Requires Smaller Outlet Box  
**Additional Options:**  
Bronze | White Glass (BZ-WG)

**C** | **CARMILLA 14" BATH SCONCE**  
KATE SPADE NEW YORK

**KS2452**  
H: 14.25" | W: 4.5" | Ext: 2.75"  
Backplate: 4.25" x 14.25" Rec.  
LED: 10.5w

**D** | **CARMILLA 24" BATH SCONCE**  
KATE SPADE NEW YORK

**KS2454**  
H: 24" | W: 4.5" | Ext: 2.75"  
Backplate: 4.25" x 24" Rec.  
LED: 17w

**E** | **CAREW LINEAR SCONCE**  
E. F. CHAPMAN

**CHD1563**  
H: 24" | W: 4.5" | Ext: 3"  
Backplate: 4" x 19" Decorative  
Socket: 2 - E12 Candelabra | Bulb: 2 - 60 C  
**Additional Options:**  
Antique-Burnished Brass | White Glass (AB-WG)  
\* Requires Smaller Outlet Box  
©EFC DESIGNS



**E** | **CHD1563PN-WG**  
Polished Nickel | White Glass

A

**ARN2611PN-WG**  
Polished Nickel | White Glass



A

**ARN2611HAB-WG**  
Hand-Rubbed Antique Brass | White Glass



C

**TOB2186BZ-WG**  
Bronze | White Glass



opposite page

**A PENZ MEDIUM CYLINDRICAL SCONCE**  
AERIN

**ARN2611**  
H: 15" | W: 4.5" | Ext: 4.5"  
Backplate: 4.5" Round  
Socket: 2 - E17 Keyless | Bulb: 2 - 40 T

B

**TOB2187PN-WG**  
Polished Nickel | White Glass



B

**TOB2187HAB-WG**  
Hand-Rubbed Antique Brass | White Glass



B

**TOB2187BZ-WG**  
Bronze | White Glass



C

**TOB2186PN-WG**  
Polished Nickel | White Glass



C

**TOB2186HAB-WG**  
Hand-Rubbed Antique Brass | White Glass



C

**TOB2186BZ-WG**  
Bronze | White Glass



**B GRAYDON SINGLE SCONCE**  
THOMAS O'BRIEN

**TOB2187**  
H: 11.5" | W: 4.25" | Ext: 7"  
Backplate: 4.5" Round  
Socket: E26 Keyless | Bulb: 60 T

**C GRAYDON DOUBLE SCONCE**  
THOMAS O'BRIEN

**TOB2186**  
H: 18" | Ext: 6.5" | Backplate: 4.25"  
Socket: 2 - E26 Keyless | Bulb: 2 - 40 T

**A MILTON ROAD BRACKET SCONCE**  
THOMAS O'BRIEN

**TOB2197**  
H: 11" | W: 4.5" | Ext: 5.75"  
Backplate: 4.5" Round  
Socket: E26 Hi-Lo | Bulb: 60 B  
**Additional Options:**  
Antique Nickel | White Glass (AN-WG)



**B MILTON ROAD MEDIUM LINEAR SCONCE**  
THOMAS O'BRIEN

**TOB2198**  
H: 14.5" | W: 3.5" | Ext: 4"  
Backplate: 2.5" x 13.5" Rec.  
Socket: 2 - E26 Keyless | Bulb: 2 - 40 B  
**Additional Options:**  
Antique Nickel | White Glass (AN-WG)  
\* Requires Smaller Outlet Box



**A TOB2197PN-WG**  
Polished Nickel | White Glass

**A TOB2197HAB-WG**  
Hand-Rubbed Antique Brass | White Glass

**A TOB2197BZ-WG**  
Bronze | White Glass

**B TOB2198PN-WG**  
Polished Nickel | White Glass

**B TOB2198HAB-WG**  
Hand-Rubbed Antique Brass | White Glass

**D TOB2198BZ-WG**  
Bronze | White Glass

**C TOB2206PN-WG**  
Polished Nickel | White Glass

**C TOB2206HAB-WG**  
Hand-Rubbed Antique Brass | White Glass

**C TOB2206BZ-WG**  
Bronze | White Glass



**D TOB2207PN-WG**  
Polished Nickel | White Glass

**D TOB2207HAB-WG**  
Hand-Rubbed Antique Brass | White Glass

**D TOB2207BZ-WG**  
Bronze | White Glass



**C MERCHANT SINGLE SCONCE**  
THOMAS O'BRIEN

**TOB2206**  
H: 12.25" | W: 4.5" | Ext: 5.75"  
Backplate: 4.5" Round  
Socket: E26 Keyless | Bulb: 40 T  
**Additional Options:**  
Chrome | White Glass (CH-WG)

**D MERCHANT DOUBLE SCONCE**  
THOMAS O'BRIEN

**TOB2207**  
H: 20.25" | W: 3.75" | Ext: 5"  
Backplate: 4.5" Round  
Socket: 2 - E26 Keyless | Bulb: 2 - 40 T  
**Additional Options:**  
Chrome | White Glass (CH-WG)

A **SLO2001CH-CG**  
Chrome | Clear Glass



A **SLO2001BZ-SG**  
Bronze | Seeded Glass



A **SL2000BZ-WG**  
Bronze | White Glass



opposite page

A **MARINE CAGED HOODED SCONCE**  
E. F. CHAPMAN

**SLO2001**  
H: 10.5" | W: 8.5" | Ext: 10"  
Backplate: 4.5" x 6.5" Rec.  
Socket: E26 Keyless | Bulb: 40 A  
\* Bulb Sold Separately (B-30M)  
©EFC DESIGNS

B **SL2000PN-WG**  
Polished Nickel | White Glass



B **SL2000HAB-WG**  
Antique-Burnished Brass | White Glass



B **SL2000BZ-WG**  
Bronze | White Glass



C **CHD2050PN-WG**  
Polished Nickel | White Glass



C **CHD2050AB-WG**  
Antique-Burnished Brass | White Glass



C **CHD2050BZ-WG**  
Bronze | White Glass



B **MARINE CAGED SCONCE**  
E. F. CHAPMAN

**SL2000**  
H: 10.5" | W: 4.5" | Ext: 7.75"  
Backplate: 4.5" x 6.5" Rec.  
Socket: E26 Keyless | Bulb: 40 A  
**Additional Options:**  
Antique Nickel | White Glass (AN-WG)  
Chrome | White Glass (CH-WG)  
©EFC DESIGNS

C **STANWAY SCONCE**  
E. F. CHAPMAN

**CHD2050**  
H: 10.75" | W: 4" | Ext: 5"  
Backplate: 3.25" x 4.5"  
Socket: E26 Keyless | Bulb: 60 A  
**Additional Options:**  
Antique Nickel | White Glass (AN-WG)  
\* Requires Smaller Outlet Box  
©EFC DESIGNS

<p><b>A</b> <b>TOB2751PN-CG</b> Polished Nickel   Clear Glass</p>	<p><b>A</b> <b>TOB2751HAB-CG</b> Hand-Rubbed Antique Brass   Clear Glass</p>	<p><b>A</b> <b>TOB2751BZ-SG</b> Bronze   Seeded Glass</p>
---	--	---



**A** **ROBINSON SINGLE SCONCE**  
THOMAS O'BRIEN

**TOB2751**  
H: 11.25" | W: 4.25" | Ext: 5.25"  
Backplate: 3.5" x 6" Rec.  
Socket: E12 Candelabra | Bulb: 60 B  
\* Requires Smaller Outlet Box

<p><b>B</b> <b>TOB2111PN-PN</b> Polished Nickel   White Glass</p>	<p><b>B</b> <b>TOB2111HAB-HAB</b> Hand-Rubbed Antique Brass   White Glass</p>	<p><b>B</b> <b>TOB2111BZ/HAB-BZ</b> Bronze   Brass   White Glass</p>
---	---	--



**B** **WHITMAN SMALL SCONCE**  
THOMAS O'BRIEN

**TOB2111**  
H: 8.5" | W: 4.75" | Ext: 6.75"  
Backplate: 4" x 6.75" Rec.  
Socket: E12 Candelabra | Bulb: 60 B

<p><b>A</b> <b>TOB2751PN-WG</b> Polished Nickel   White Glass</p>	<p><b>A</b> <b>TOB2751HAB-WG</b> Hand-Rubbed Antique Brass   White Glass</p>	<p><b>A</b> <b>TOB2751BZ-WG</b> Bronze   White Glass</p>
---	--	--



<p><b>B</b> <b>TOB2111PN-WG</b> Polished Nickel   White Glass</p>	<p><b>B</b> <b>TOB2111HAB-WG</b> Hand-Rubbed Antique Brass   White Glass</p>	<p><b>B</b> <b>TOB2111BZ/HAB-WG</b> Bronze   Brass   White Glass</p>
---	--	--



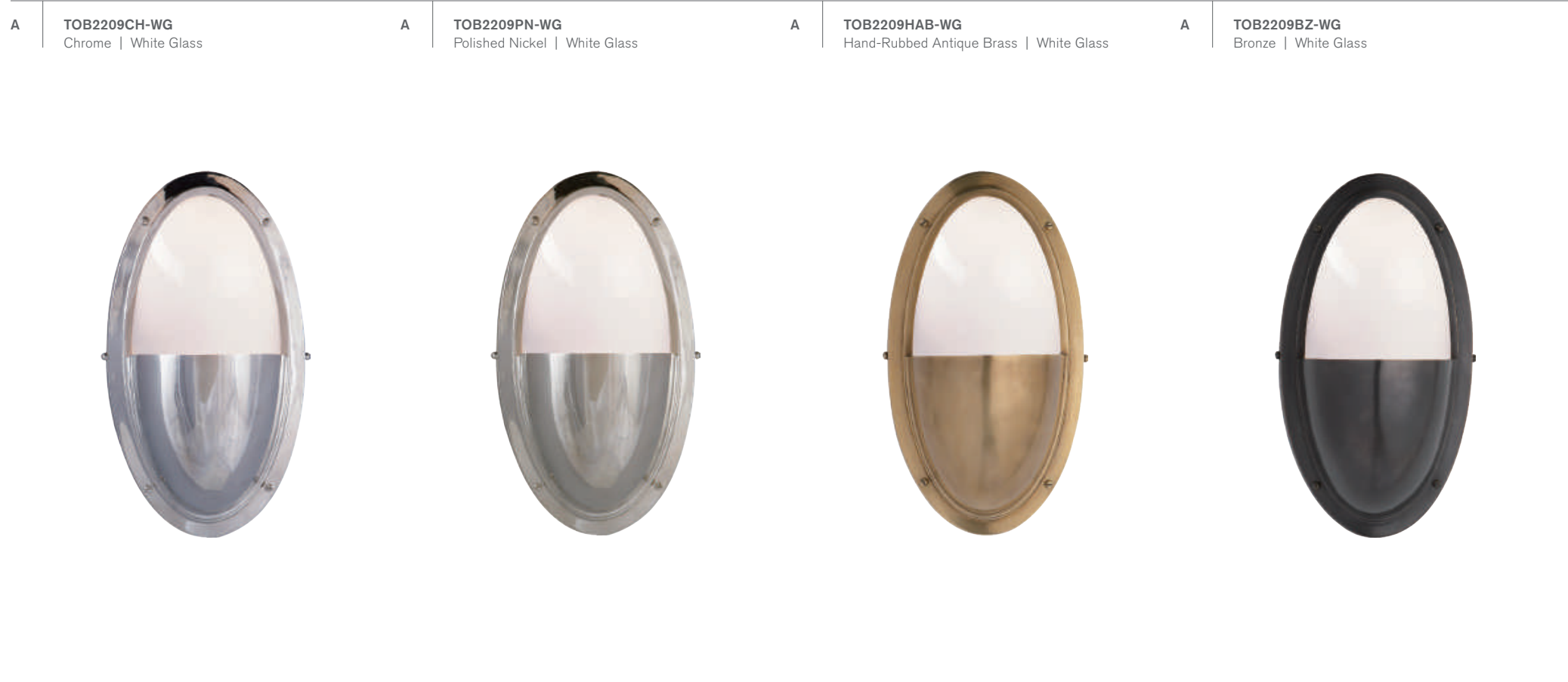

**A** **TOB2209CH-WG**  
Chrome | White Glass

**A** **TOB2209PN-WG**  
Polished Nickel | White Glass

**A** **TOB2209HAB-WG**  
Hand-Rubbed Antique Brass | White Glass

**A** **TOB2209BZ-WG**  
Bronze | White Glass

**A** **PELHAM OVAL SCONCE**  
THOMAS O'BRIEN

**TOB2209**  
H: 11.5" | W: 6.25" | Ext: 3.75"  
Backplate: 6.25" x 11.5" Oval  
Socket: E26 Keyless | Bulb: 60 B

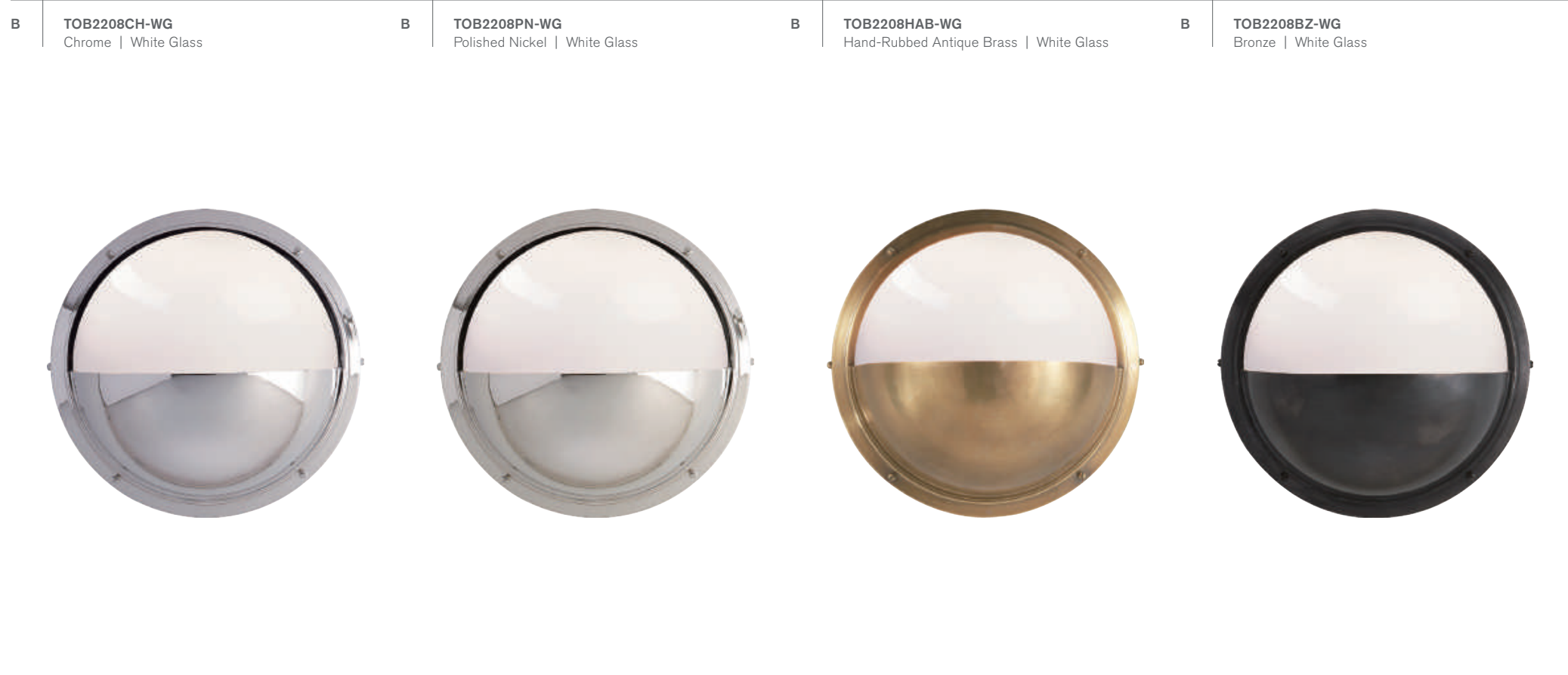

**B** **TOB2208CH-WG**  
Chrome | White Glass

**B** **TOB2208PN-WG**  
Polished Nickel | White Glass

**B** **TOB2208HAB-WG**  
Hand-Rubbed Antique Brass | White Glass

**B** **TOB2208BZ-WG**  
Bronze | White Glass

**B** **PELHAM MOON SCONCE**  
THOMAS O'BRIEN

**TOB2208**  
H: 10" | W: 10" | Ext: 5.25"  
Backplate: 10" Round  
Socket: E26 Keyless | Bulb: 60 B

**B** **TOB2208BZ-WG**  
Bronze | White Glass





**A** | **ARN2255PN-CG**  
Polished Nickel | Clear Glass



**A** | **ARN2255HAB-CG**  
Hand-Rubbed Antique Brass | Clear Glass



**C** | **TOB2022PN-WG**  
Polished Nickel | White Glass

**B** | **TOB2015PN-WG**  
Polished Nickel | White Glass



**B** | **TOB2015AN-WG**  
Antique Nickel | White Glass



**B** | **TOB2015HAB-WG**  
Hand-Rubbed Antique Brass | White Glass



**C** | **TOB2022PN-WG**  
Polished Nickel | White Glass



**C** | **TOB2022AN-WG**  
Antique Nickel | White Glass



**C** | **TOB2022HAB-WG**  
Hand-Rubbed Antique Brass | White Glass



**C** | **TOB2022BZ-WG**  
Bronze | White Glass



opposite page

**A** | **TURENNE SMALL SCONCE**  
AERIN

**ARN2255**  
H: 9.75" | W: 12.5" | Ext: 7"  
Backplate: 4.25" Round  
Socket: E12 Candelabra | Bulb: 40 B

**B** | **BRYANT GLASS SCONCE**  
THOMAS O'BRIEN

**TOB2015**  
H: 14" | W: 4" | Ext: 8.25"  
Backplate: 4" Round  
Socket: E26 Keyless | Bulb: 60 T  
**Additional Options:**  
Bronze | White Glass (BZ-WG)  
\* Requires Smaller Outlet Box

**C** | **BRYANT SCONCE**  
THOMAS O'BRIEN

**TOB2022**  
H: 14.5" | W: 5.5" | Ext: 8.75"  
Backplate: 4" Round  
Socket: E26 Keyless | Bulb: 40 B  
\* Requires Smaller Outlet Box



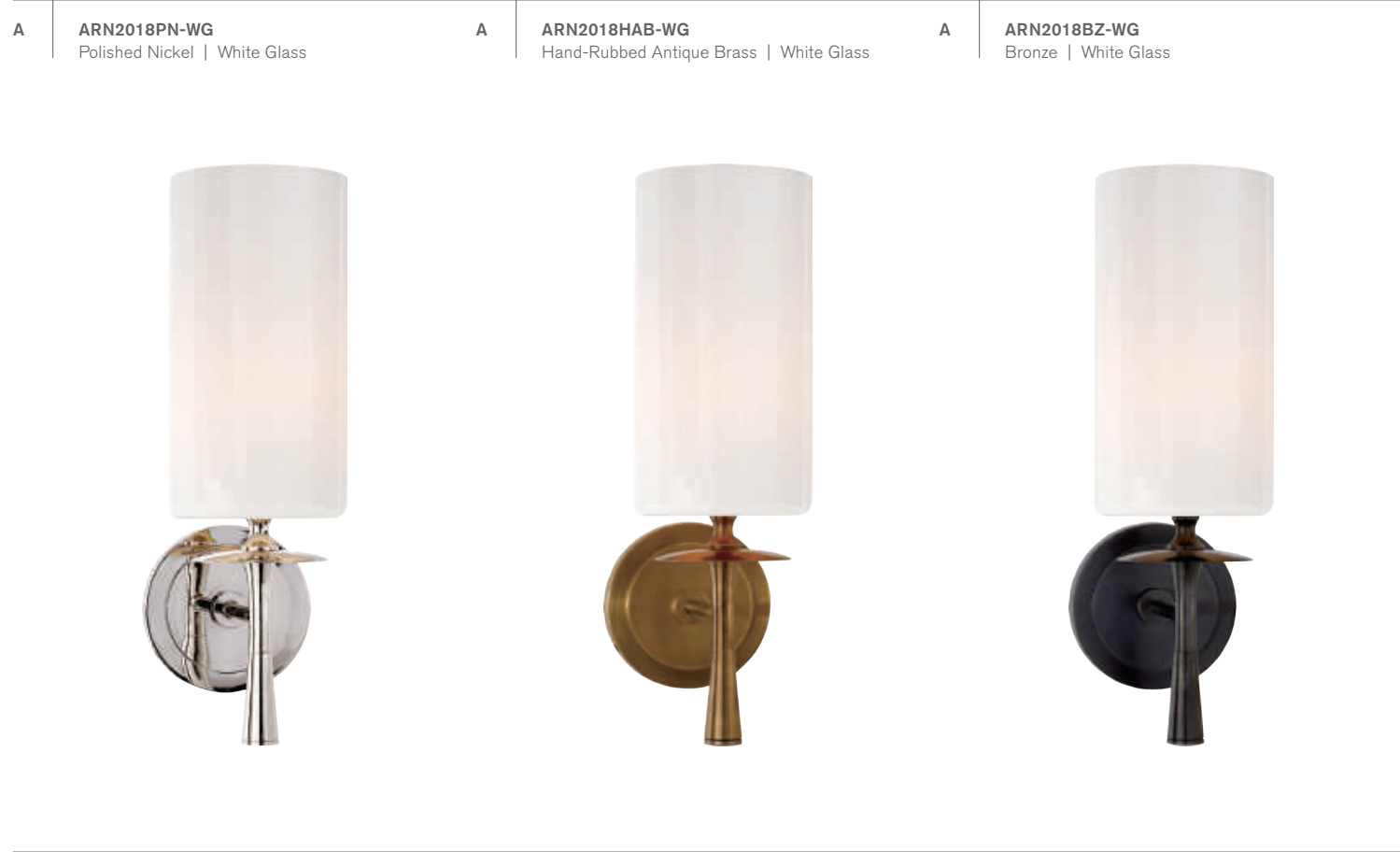
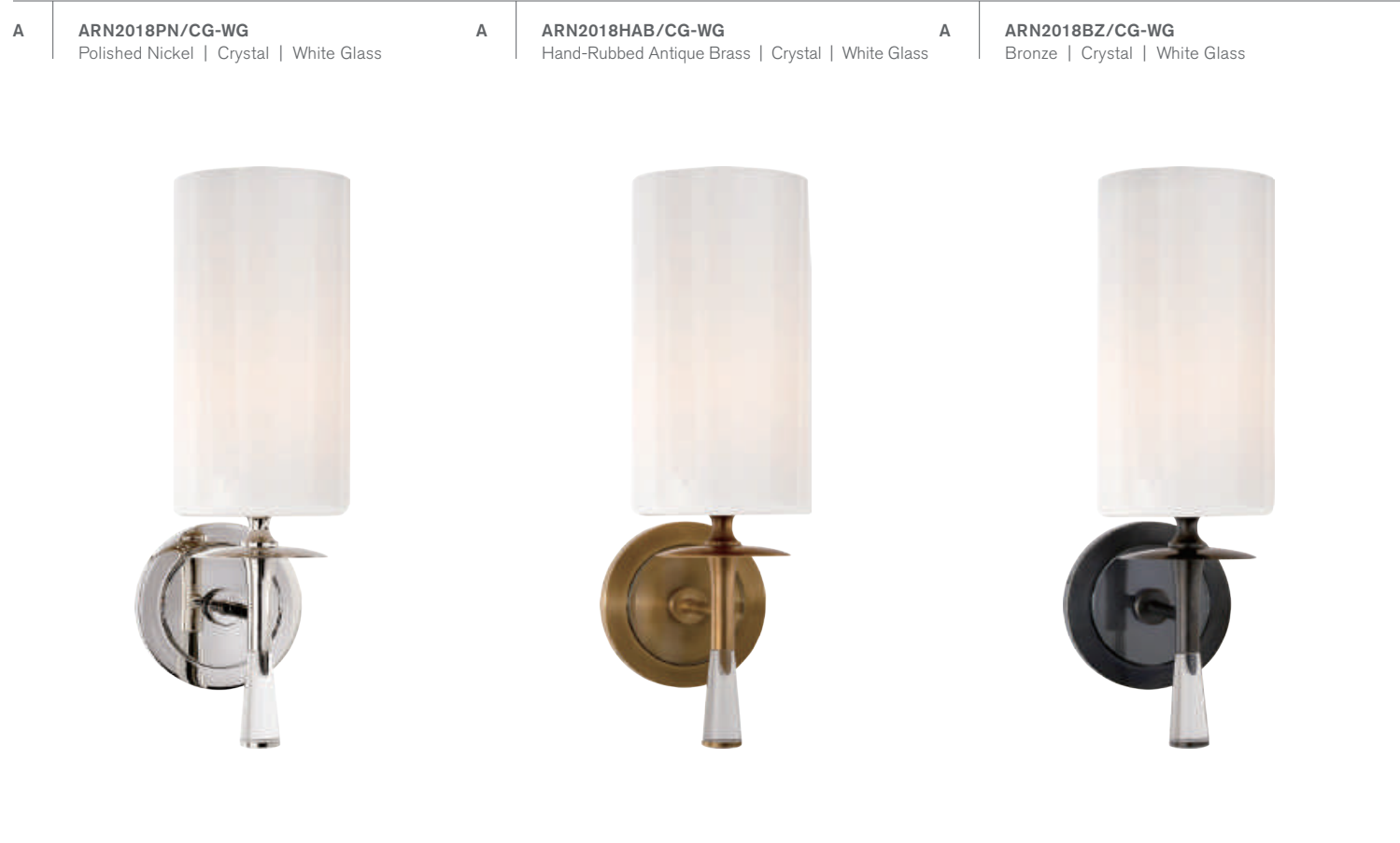

**A** | **DRUNMORE SINGLE SCONCE**  
AERIN

**ARN2018**  
H: 14.25" | W: 4.5" | Ext: 6.75"  
Backplate: 4.5" Round  
Socket: E12 Candelabra | Bulb: 40 B  
Shade: 4.5" x 4.5" x 8.5"

opposite page

**B** | **CYLINDER SCONCE**  
STUDIO VC

**S2006**  
H: 13" | W: 5.5" | Ext: 5.5"  
Backplate: 5.5" Round  
Socket: E26 Keyless | Bulb: 60 B  
Glass: 4.25" x 8"  
**Additional Options:**  
Hand-Rubbed Antique Brass | White Glass (HAB-WG)



**A** | **ARN2018BZ-WG**  
Bronze | White Glass

**B** | **S2006PN-WG**  
Polished Nickel | White Glass



**B** | **S2006BZ-WG**  
Bronze | White Glass



A

SL2935AN-WG  
Antique Nickel | White Glass



A **BOSTON HEAD LIGHT SCONCE**  
E. F. CHAPMAN

**SL2935**  
H: 11.5" | W: 6" | Ext: 6.25"  
Backplate: 4.75" Round  
Socket: E26 On-Off | Bulb: 60 B  
**Additional Options:**  
Chrome | White Glass (CH-WG)  
©EFC DESIGNS

A

SL2935PN-WG  
Polished Nickel | White Glass



A

SL2935AN-WG  
Antique Nickel | White Glass



A

SL2935HAB-WG  
Hand-Rubbed Antique Brass | White Glass



A

SL2935BZ-WG  
Bronze | White Glass



B **BOSTON LOOP ARM SCONCE**  
E. F. CHAPMAN

**SL2934**  
H: 12.5" | W: 4.75" | Ext: 7.5"  
Backplate: 4.75" Round  
Socket: E26 On-Off | Bulb: 60 B  
**Additional Options:**  
Antique Nickel | White Glass (AN-WG)  
Bronze | Clear Glass (BZ-CG)  
Chrome | Clear Glass (CH-CG)  
Chrome | White Glass (CH-WG)  
Hand-Rubbed Antique Brass | Clear Glass (HAB-CG)  
Polished Nickel | White Glass (PN-WG)  
©EFC DESIGNS

B

SL2934PN-CG  
Polished Nickel | Clear Glass



B

SL2934AN-CG  
Antique Nickel | Clear Glass



B

SL2934HAB-WG  
Hand-Rubbed Antique Brass | White Glass



B

SL2934BZ-WG  
Bronze | White Glass



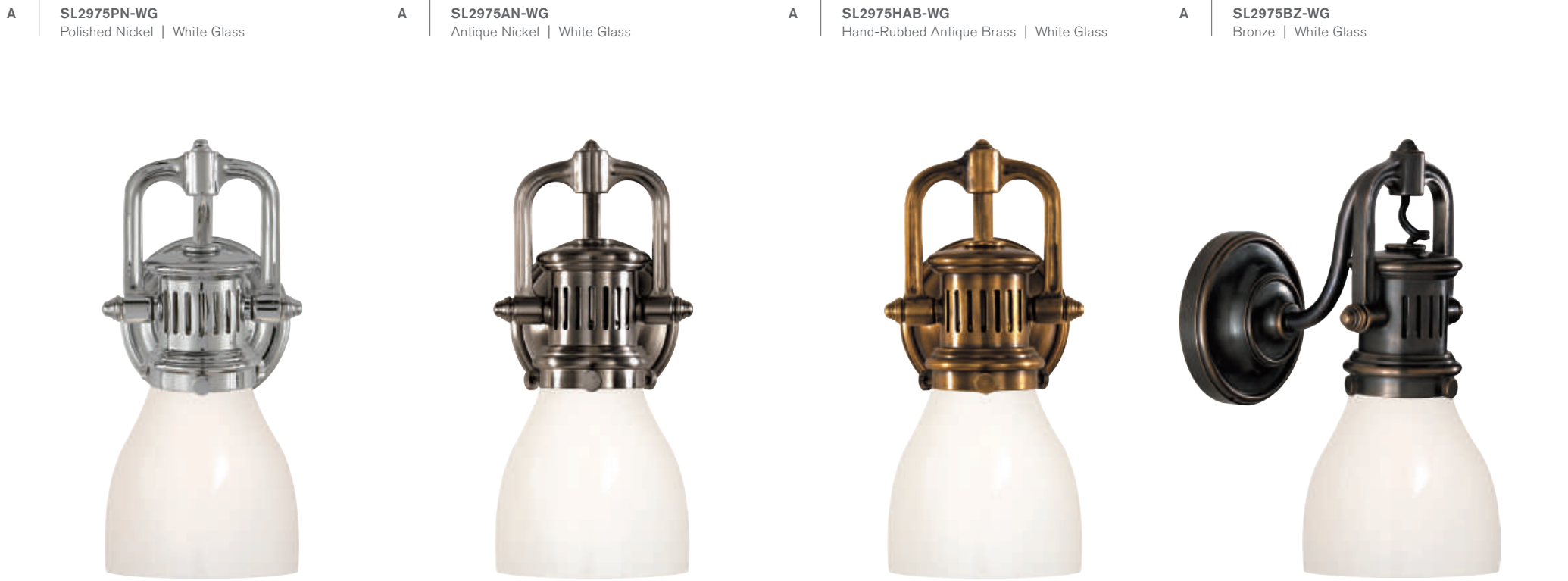

**A** | **YOKE SUSPENDED SCONCE**  
E. F. CHAPMAN

**SL2975**  
H: 10.25" | W: 5" | Ext: 9.5"  
Backplate: 4.5" Round  
Socket: E26 Keyless | Bulb: 60 B  
**Additional Options:**  
Bronze | Bronze (BZ-BZ)  
Bronze | Brass (BZ-HAB)  
Hand-Rubbed Antique Brass | Antique Nickel (HAB-AN)  
Hand-Rubbed Antique Brass | Bronze (HAB-BZ)  
©EFC DESIGNS

**A** | **SL2975PN-WG**  
Polished Nickel | White Glass

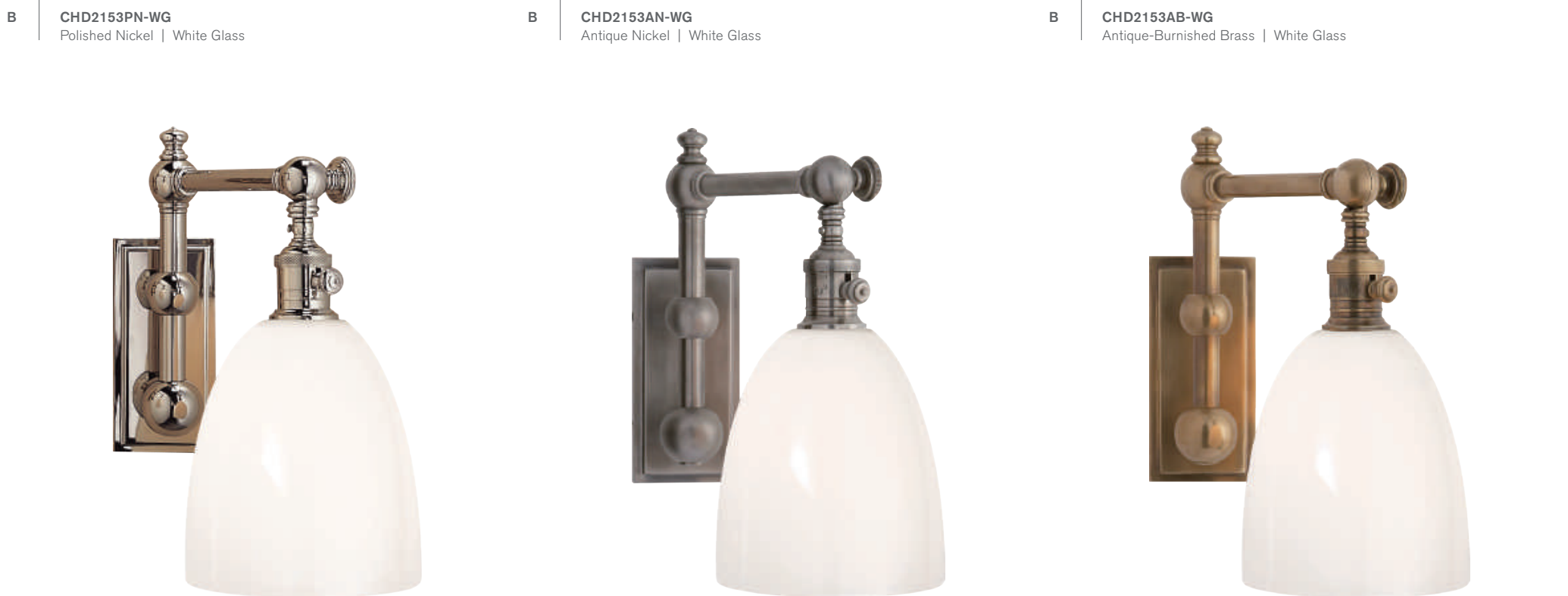

**B** | **PIMLICO SINGLE LIGHT SCONCE**  
E. F. CHAPMAN

**CHD2153**  
H: 11" | W: 6" | Ext: 12"  
Backplate: 3" x 6.5" Rec.  
Socket: E26 On-Off | Bulb: 60 B  
\* Requires Smaller Outlet Box  
©EFC DESIGNS



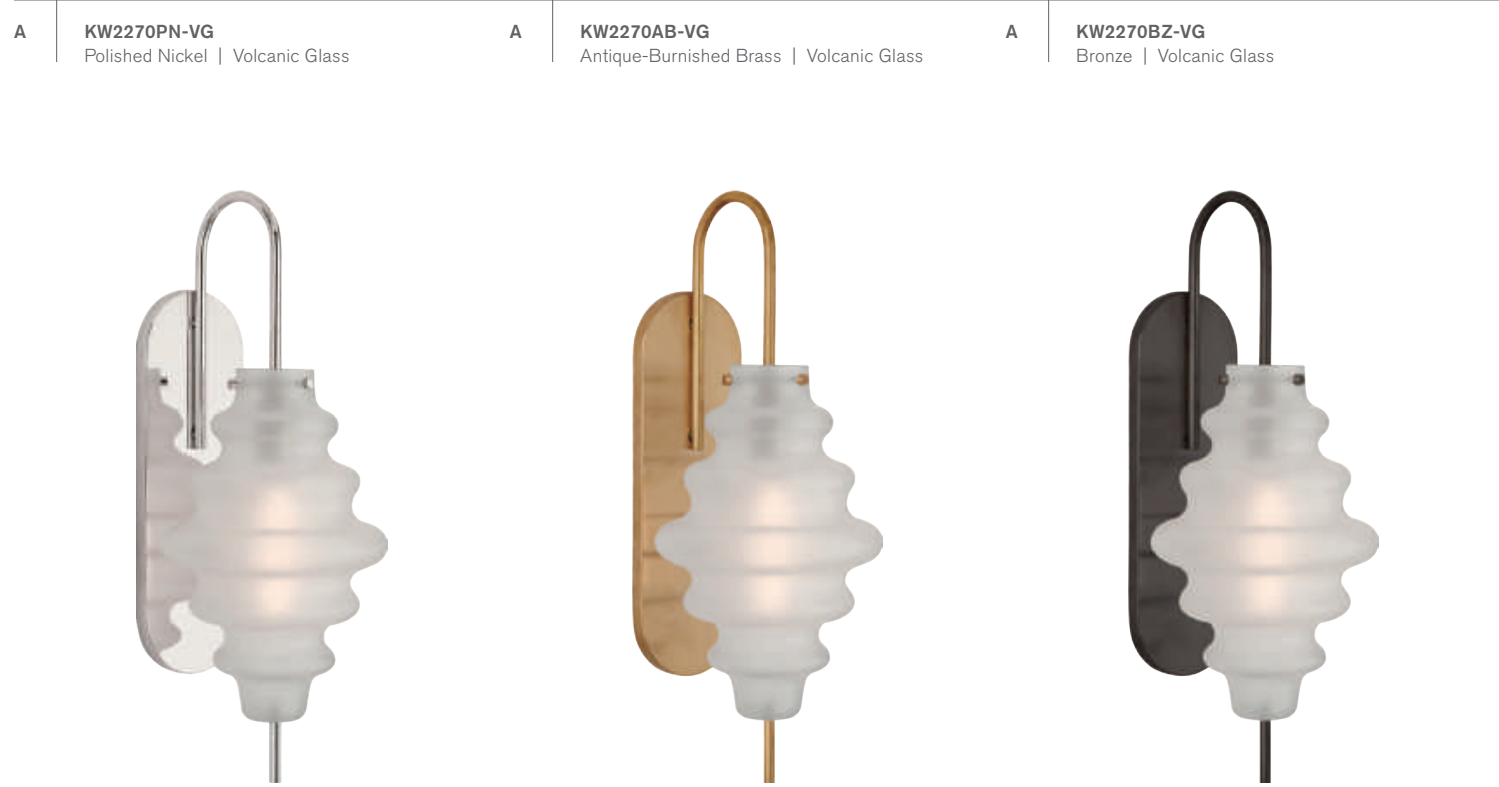
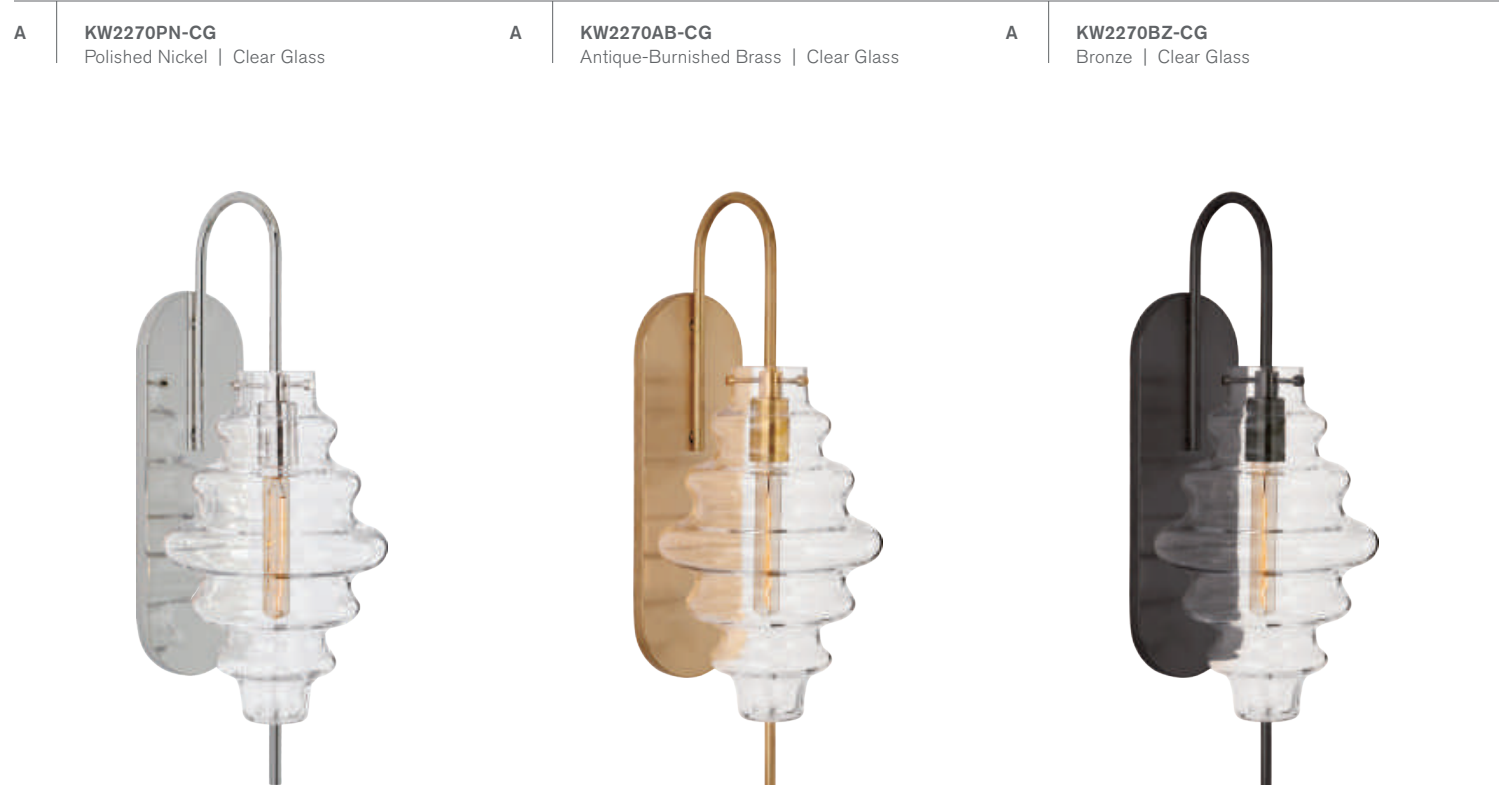

**A** **TABLEAU LARGE SCONCE**  
KELLY WEARSTLER

**KW2270**  
H: 17.5" | W: 6.75" | Ext: 7.25"  
Backplate: 4" x 12" Oval  
Socket: E26 Keyless | Bulb: 40 T

opposite page

**B** **COVINGTON SHIELD SCONCE**  
E. F. CHAPMAN

**CHD2473**  
H: 12.75" | W: 7.75" | Ext: 8.5"  
Backplate: 4.5" x 5" Rec.  
Socket: E26 Keyless | Bulb: 60 A  
©EFC DESIGNS

**C** **COVINGTON NARROW SCONCE**  
E. F. CHAPMAN

**CHD2474**  
H: 10.5" | W: 4.5" | Ext: 6"  
Backplate: 4.5" x 5" Rec.  
Socket: E26 Keyless | Bulb: 60 A  
©EFC DESIGNS

**D** **COVINGTON WIDE SCONCE**  
E. F. CHAPMAN

**CHD2472**  
H: 12.75" | W: 6.5" | Ext: 8"  
Backplate: 4.5" x 5" Rec.  
Socket: E26 Keyless | Bulb: 60 A  
©EFC DESIGNS



A

**TOB2225PN/G3-CG**  
Polished Nickel | Clear Glass



A

**TOB2225HAB/G3-SG**  
Hand-Rubbed Antique Brass | Seeded Glass



A

**TOB2225BZ/G3-WG**  
Bronze | White Glass



opposite page

**A KATIE SMALL CYLINDER SCONCE**  
THOMAS O'BRIEN

**TOB22253**  
H: 16.25" | W: 5.25" | Ext: 7.5"  
Backplate: 5.25" Round  
Socket: E12 Candelabra | Bulb: 40 C

B

**TOB2225PN/G4-CG**  
Polished Nickel | Clear Glass



B

**TOB2225HAB/G4-SG**  
Hand-Rubbed Antique Brass | Seeded Glass



B

**TOB2225BZ/G4-WG**  
Bronze | White Glass



C

**TOB2225PN/G2-CG**  
Polished Nickel | Clear Glass



C

**TOB2225HAB/G2-SG**  
Hand-Rubbed Antique Brass | Seeded Glass



C

**TOB2225BZ/G2-WG**  
Bronze | White Glass



D

**TOB2225PN/G6-CG**  
Polished Nickel | Clear Glass



D

**TOB2225HAB/G6-SG**  
Hand-Rubbed Antique Brass | Seeded Glass



D

**TOB2225BZ/G6-WG**  
Bronze | White Glass



B

**KATIE SMALL GLOBE SCONCE**  
THOMAS O'BRIEN

**TOB22254**  
H: 12.5" | W: 8" | Ext: 9.75"  
Backplate: 5.25" Round  
Socket: E12 Candelabra | Bulb: 40 C

C

**KATIE SMALL ACORN SCONCE**  
THOMAS O'BRIEN

**TOB22252**  
H: 13.4" | W: 6.5" | Ext: 8.75"  
Backplate: 5.25" Round  
Socket: E12 Candelabra | Bulb: 40 C

D

**KATIE SMALL CONICAL SCONCE**  
THOMAS O'BRIEN

**TOB22256**  
H: 14.4" | W: 9.4" | Ext: 10.25"  
Backplate: 5.25" Round  
Socket: E12 Candelabra | Bulb: 40 C

**Available Options for Katie Sconce:**  
Bronze (BZ)  
Hand-Rubbed Antique Brass (HAB)  
Polished Nickel (PN)  
Clear Glass (CG)  
Seeded Glass (SG)  
White Glass (WG)



A   <b>S2024PN-CG</b> Polished Nickel   Clear Glass	A   <b>S2024PN/BLK-CG</b> Black   Nickel   Clear Glass	A   <b>S2024HAB/BLK-WG</b> Black   Brass   White Glass	B   <b>S2026PN-CG</b> Polished Nickel   Clear Glass	B   <b>S2026HAB/BLK-WG</b> Black   Brass   White Glass
--	---	---	--	---



C   <b>S2025PN/BLK-CG</b> Black   Nickel   Clear Glass	C   <b>S2025HAB/BLK-WG</b> Black   Brass   White Glass
---	---



opposite page

**A BISTRO ONE LIGHT SCONCE**  
IAN K. FOWLER

**S2024**  
H: 11.75" | W: 6" | Ext: 7.5"  
Backplate: 4.5" Round  
Socket: E12 Candelabra | Bulb: 40 G

**B BISTRO TWO LIGHT SCONCE**  
IAN K. FOWLER

**S2026**  
H: 10.75" | W: 14" | Ext: 7"  
Backplate: 4.5" Round  
Socket: 2 - E12 Candelabra | Bulb: 2 - 40 G  
**Additional Options:**  
Black | Nickel | Clear Glass (PN/BLK-CG)

**C BISTRO FOUR LIGHT SCONCE**  
IAN K. FOWLER

**S2025**  
H: 10.75" | W: 30" | Ext: 7"  
Backplate: 4.5" Round  
Socket: 4 - E12 Candelabra | Bulb: 4 - 40 G  
**Additional Options:**  
Polished Nickel | Clear Glass (PN-CG)

D   <b>S2022HAB-WG</b> Hand-Rubbed Antique Brass   White Glass
---

**D BISTRO VERTICAL SCONCE**  
IAN K. FOWLER

**S2022**  
H: 32" | W: 6" | Ext: 11.5"  
Backplate: 4.5" Round  
Socket: 2 - E12 Candelabra | Bulb: 2 - 40 G  
**Additional Options:**  
Polished Nickel | Clear Glass (PN-CG)



**A** | **KW2118AB-CRG**  
Antique-Burnished Brass | Crackle Glass



**A** | **KW2118BZ-CRG**  
Bronze | Crackle Glass



**A** | **KW2118PN-CRG**  
Polished Nickel | Crackle Glass



opposite page

**A** | **LIAISON MEDIUM TUBE SCONCE**  
KELLY WEARSTLER

**KW2118**  
H: 21" | W: 5.25" | Ext: 5"  
Backplate: 5.25" Round  
Socket: 2 - E17 Keyless | Bulb: 2 - 40 T

**B** | **S2165PN-CG**  
Polished Nickel | Clear Glass



**B** | **S2165HAB-CG**  
Hand-Rubbed Antique Brass | Clear Glass



**B** | **S2165BZ-CG**  
Bronze | Clear Glass



**C** | **S2166PN-CG**  
Polished Nickel | Clear Glass



**C** | **S2166HAB-CG**  
Hand-Rubbed Antique Brass | Clear Glass



**C** | **S2166BZ-CG**  
Bronze | Clear Glass



**B** | **PRESIDIO PETITE SCONCE**  
IAN K. FOWLER

**S2165**  
H: 14" | W: 4.75" | Ext: 4.5"  
Backplate: 4.75" x 6.25" Rec.  
Socket: E26 Keyless | Bulb: 60 T

**C** | **PRESIDIO SMALL SCONCE**  
IAN K. FOWLER

**S2166**  
H: 14" | W: 5" | Ext: 7.75"  
Backplate: 4" x 6" Rec.  
Socket: E26 Keyless | Bulb: 60 T

A	<b>TOB2318PN-CG</b> Polished Nickel   Clear Glass	A	<b>TOB2318HAB-CG</b> Hand-Rubbed Antique Brass   Clear Glass
---	--	---	---



A	<b>MARAIS LINEAR BATH SCONCE</b> THOMAS O'BRIEN
---	--

**TOB2318**  
 H: 21" | W: 4.25" | Ext: 4.5"  
 Backplate: 4.25" x 5.5" Rec.  
 Socket: 2 - E26 Keyless | Bulb: 2 - 40 T

B	<b>MARAIS LARGE DOUBLE BATH SCONCE</b> THOMAS O'BRIEN
---	--

**TOB2315**  
 H: 19.75" | W: 4.75" | Ext: 6"  
 Backplate: 4.75" x 5.5" Rec.  
 Socket: 2 - E26 Keyless | Bulb: 2 - 40 A  
**Additional Options:**  
 Bronze | Antique Brass | White Glass (BZ/HAB-WG)  
 Hand-Rubbed Antique Brass | White Glass (HAB-WG)  
 Polished Nickel | Clear Glass (PN-CG)

opposite page

C	<b>MARAIS MEDIUM BATH SCONCE</b> THOMAS O'BRIEN
---	--

**TOB2314**  
 H: 11.25" | W: 4.25" | Ext: 6.5"  
 Backplate: 4.25" x 5.5" Rec.  
 Socket: E26 Keyless | Bulb: 60 A  
**Additional Options:**  
 Hand-Rubbed Antique Brass | Clear Glass (HAB-CG)  
 Polished Nickel | White Glass (PN-WG)

D	<b>MARAIS FOUR-LIGHT BATH SCONCE</b> THOMAS O'BRIEN
---	--

**TOB2316**  
 H: 8" | W: 20.25" | Ext: 6.25"  
 Backplate: 4" x 4.5" Rec.  
 Socket: 4 - E12 Candelabra | Bulb: 4 - 40 B  
 Shade: 3" x 5.25"  
 \* Weight Requires Special Installation  
**Additional Options:**  
 Bronze | Antique Brass | White Glass (BZ/HAB-WG)  
 Hand-Rubbed Antique Brass | White Glass (HAB-WG)  
 Polished Nickel | Clear Glass (PN-CG)

E	<b>MARAIS SIX-LIGHT BATH SCONCE</b> THOMAS O'BRIEN
---	---

**TOB2317**  
 H: 8" | W: 29" | Ext: 6.75"  
 Backplate: 4.25" x 5.5" Rec.  
 Socket: 6 - E12 Candelabra | Bulb: 6 - 40 B  
 Shade: 3" x 5.25"  
 \* Weight Requires Special Installation  
**Additional Options:**  
 Bronze | Antique Brass | White Glass (BZ/HAB-WG)  
 Hand-Rubbed Antique Brass | Clear Glass (HAB-CG)  
 Hand-Rubbed Antique Brass | White Glass (HAB-WG)  
 Polished Nickel | White Glass (PN-WG)

C	<b>TOB2314PN-CG</b> Polished Nickel   Clear Glass	C	<b>TOB2314BZ/HAB-CG</b> Bronze   Hand-Rubbed Antique Brass   Clear Glass	C	<b>TOB2314HAB-WG</b> Hand-Rubbed Antique Brass   White Glass	C	<b>TOB2314BZ/HAB-WG</b> Bronze   Hand-Rubbed Antique Brass   White Glass
---	--	---	---	---	---	---	---



D	<b>TOB2316PN-WG</b> Polished Nickel   White Glass	D	<b>TOB2316HAB-CG</b> Hand-Rubbed Antique Brass   Clear Glass	D	<b>TOB2316BZ/HAB-CG</b> Bronze   Hand-Rubbed Antique Brass   Clear Glass
---	--	---	---	---	---



E	<b>TOB2317PN-CG</b> Polished Nickel   Clear Glass	E	<b>TOB2317BZ/HAB-CG</b> Bronze   Hand-Rubbed Antique Brass   Clear Glass
---	--	---	---





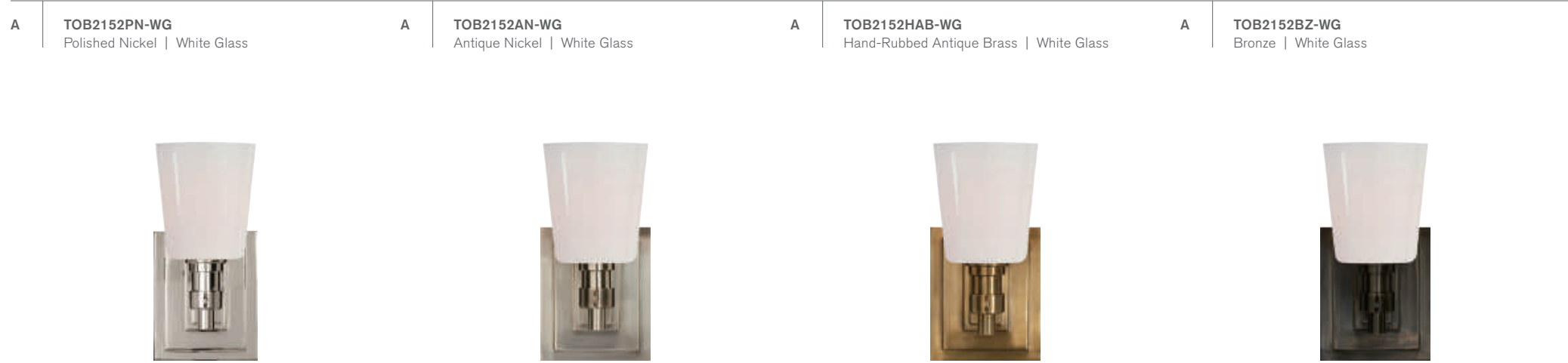

**A** **BRYANT ONE LIGHT BATH SCONCE**  
THOMAS O'BRIEN

**TOB2152**  
H: 8" | W: 4" | Ext: 5.5"  
Backplate: 4" x 5" Rec.  
Socket: E12 Candelabra | Bulb: 4 - 60 B

**B** **BRYANT FOUR LIGHT BATH SCONCE**  
THOMAS O'BRIEN

**TOB2153**  
H: 8" | W: 19.5" | Ext: 5.5"  
Backplate: 4" x 5" Rec.  
Socket: 4 - E12 Candelabra | Bulb: 4 - 60 B

**C** **BRYANT SIX LIGHT BATH SCONCE**  
THOMAS O'BRIEN

**TOB2154**  
H: 8" | W: 29" | Ext: 5.5"  
Backplate: 4" x 5" Rec.  
Socket: 6 - E12 Candelabra | Bulb: 6 - 60 B  
**Additional Options:**  
Bronze | White Glass (BZ-WG)  
Polished Nickel | White Glass (PN-WG)



**B** **TOB2153PN-WG**  
Polished Nickel | White Glass

**A WILTON SINGLE BATH SCONCE**  
 E. F. CHAPMAN

**SL2841**  
 H: 10.25" | W: 5" | Ext: 8.75"  
 Backplate: 5" Round  
 Socket: E26 Keyless | Bulb: 60 A  
**Additional Options:**  
 Chrome | White Glass (CH-WG)  
 ©EFC DESIGNS

**B WILTON DOUBLE BATH SCONCE**  
 E. F. CHAPMAN

**SL2842**  
 H: 10.25" | W: 13" | Ext: 8.75"  
 Backplate: 5" Round  
 Socket: 2 - E26 Keyless | Bulb: 2 - 60 A  
**Additional Options:**  
 Antique Nickel | White Glass (AN-WG)  
 Polished Nickel | White Glass (PN-WG)  
 ©EFC DESIGNS

**C WILTON TRIPLE BATH SCONCE**  
 E. F. CHAPMAN

**SL2843**  
 H: 10.5" | W: 21.5" | Ext: 8.75"  
 Backplate: 5" Round  
 Socket: 3 - E26 Keyless | Bulb: 3 - 60 A  
**Additional Options:**  
 Antique Nickel | White Glass (AN-WG)  
 Chrome | White Glass (CH-WG)  
 Polished Nickel | White Glass (PN-WG)  
 ©EFC DESIGNS

**D NEW YORK SUBWAY SINGLE SCONCE**  
 E. F. CHAPMAN

**SL2151**  
 H: 9.75" | W: 5" | Ext: 8"  
 Backplate: 4.5" Square  
 Socket: E26 Keyless | Bulb: 60 A  
**Additional Options:**  
 Chrome | White Glass (CH-WG)  
 ©EFC DESIGNS

**E NEW YORK SUBWAY DOUBLE SCONCE**  
 E. F. CHAPMAN

**SL2152**  
 H: 9.75" | W: 14" | Ext: 8"  
 Backplate: 4.5" Square  
 Socket: 2 - E26 Keyless | Bulb: 2 - 60 A  
**Additional Options:**  
 Antique Nickel | White Glass (AN-WG)  
 Polished Nickel | White Glass (PN-WG)  
 ©EFC DESIGNS

**F NEW YORK SUBWAY TRIPLE SCONCE**  
 E. F. CHAPMAN

**SL2153**  
 H: 9.75" | W: 22.75" | Ext: 8"  
 Backplate: 4.5" Square  
 Socket: 3 - E26 Keyless | Bulb: 3 - 60 A  
**Additional Options:**  
 Antique Nickel | White Glass (AN-WG)  
 Chrome | White Glass (CH-WG)  
 Polished Nickel | White Glass (PN-WG)  
 ©EFC DESIGNS



A	SL2941PN-FG Polished Nickel   Frosted Glass	A	SL2941AN-FG Antique Nickel   Frosted Glass	A	SL2941HAB-FG Hand-Rubbed Antique Brass   Frosted Glass	A	SL2941BZ-FG Bronze   Frosted Glass
---	--	---	---	---	---	---	---------------------------------------



**A BOSTON SQUARE SINGLE LIGHT**  
E. F. CHAPMAN

**SL2941**  
H: 11" | W: 5" | Ext: 8.5"  
Backplate: 4.5" x 5" Rec.  
Socket: E26 Hi-Lo | Bulb: 60 B  
**Additional Options:**  
Chrome | Frosted Glass (CH-FG)  
©EFC DESIGNS

D	SS2001PN-WG Polished Nickel   White Glass	D	SS2001HAB-WG Hand-Rubbed Antique Brass   White Glass	D	SS2001BZ-WG Bronze   White Glass
---	--	---	---	---	-------------------------------------



**D SIENA SINGLE SCONCE**  
STUDIO VC

**SS2001**  
H: 8.25" | W: 4.75" | Ext: 6.5"  
Backplate: 4.75" Square  
Socket: E26 Keyless | Bulb: 40 A

B	SL2942CH-FG Chrome   Frosted Glass	B	SL2942HAB-FG Hand-Rubbed Antique Brass   Frosted Glass	B	SL2942BZ-FG Bronze   Frosted Glass
---	---------------------------------------	---	---	---	---------------------------------------



**B BOSTON SQUARE DOUBLE LIGHT**  
E. F. CHAPMAN

**SL2942**  
H: 11" | W: 14" | Ext: 8.5"  
Backplate: 4.5" x 5" Rec.  
Socket: 2 - E26 Hi-Lo | Bulb: 2 - 60 B  
**Additional Options:**  
Antique Nickel | Frosted Glass (AN-FG)  
Polished Nickel | Frosted Glass (PN-FG)  
©EFC DESIGNS

E	SS2002PN-WG Polished Nickel   White Glass	E	SS2002HAB-WG Hand-Rubbed Antique Brass   White Glass	E	SS2002BZ-WG Bronze   White Glass
---	--	---	---	---	-------------------------------------



**E SIENA DOUBLE SCONCE**  
STUDIO VC

**SS2002**  
H: 8.25" | W: 15" | Ext: 6"  
Backplate: 4.75" Square  
Socket: 2 - E26 Keyless | Bulb: 2 - 60 A

C	SL2943PN-FG Polished Nickel   Frosted Glass	C	SL2943HAB-FG Hand-Rubbed Antique Brass   Frosted Glass
---	--	---	---



**C BOSTON SQUARE TRIPLE LIGHT**  
E. F. CHAPMAN

**SL2943**  
H: 11" | W: 22" | Ext: 8.5"  
Backplate: 4.5" x 5" Rec.  
Socket: 3 - E26 Hi-Lo | Bulb: 3 - 60 B  
**Additional Options:**  
Antique Nickel | Frosted Glass (AN-FG)  
Bronze | Frosted Glass (BZ-FG)  
Chrome | Frosted Glass (CH-FG)  
©EFC DESIGNS

F	SS2003PN-WG Polished Nickel   White Glass	F	SS2003HAB-WG Hand-Rubbed Antique Brass   White Glass
---	--	---	---



**F SIENA TRIPLE SCONCE**  
STUDIO VC

**SS2003**  
H: 8.25" | W: 23" | Ext: 10.75"  
Backplate: 4.75" Square  
Socket: 3 - E26 Keyless | Bulb: 3 - 60 A  
**Additional Options:**  
Bronze | White Glass (BZ-WG)

**A BOSTON SINGLE LIGHT**  
E. F. CHAPMAN

**SL2931**  
H: 9" | W: 5.75" | Ext: 9.5"  
Backplate: 4.5" Round  
Socket: E26 Hi-Lo | Bulb: 60 B  
**Additional Options:**  
Chrome (CH)  
\* Bulb Sold Separately (B-30M)  
©EFC DESIGNS

**B BOSTON DOUBLE LIGHT**  
E. F. CHAPMAN

**SL2932**  
H: 9" | W: 12" | Ext: 9.5"  
Backplate: 4.5" Round  
Socket: 2 - E26 Hi-Lo | Bulb: 2 - 60 B  
**Additional Options:**  
Antique Nickel (AN)  
Polished Nickel (PN)  
\* Bulb Sold Separately (B-30M)  
©EFC DESIGNS

**C BOSTON TRIPLE LIGHT**  
E. F. CHAPMAN

**SL2933**  
H: 9" | W: 23" | Ext: 9.5"  
Backplate: 4.5" Round  
Socket: 3 - E26 Hi-Lo | Bulb: 3 - 60 B  
**Additional Options:**  
Antique Nickel (AN)  
Bronze (BZ)  
Chrome (CH)  
\* Bulb Sold Separately (B-30M)  
©EFC DESIGNS

**D SL2931PN/SLEG-WG**  
Polished Nickel | White Glass**D SL2931HAB/SLEG-WG**  
Hand-Rubbed Antique Brass | White Glass**D SL2931AN/SLEG-WG**  
Antique Nickel | White Glass**D SL2931BZ/SLEG-WG**  
Bronze | White Glass**D BOSTON FUNCTIONAL SINGLE LIGHT**  
E. F. CHAPMAN

**SL2931**  
H: 9" | W: 5.75" | Ext: 9.5"  
Backplate: 4.5" Round  
Socket: E26 Hi-Lo | Bulb: 60 B  
**Additional Options:**  
Chrome | White Glass (CH/SLEG-WG)  
©EFC DESIGNS

**E SL2932CH/SLEG-WG**  
Chrome | White Glass**E SL2932HAB/SLEG-WG**  
Hand-Rubbed Antique Brass | White Glass**E SL2932BZ/SLEG-WG**  
Bronze | White Glass**E BOSTON FUNCTIONAL DOUBLE LIGHT**  
E. F. CHAPMAN

**SL2932**  
H: 9" | W: 14.5" | Ext: 9.5"  
Backplate: 4.5" Round  
Socket: 2 - E26 Hi-Lo | Bulb: 2 - 60 B  
**Additional Options:**  
Antique Nickel | White Glass (AN/SLEG-WG)  
Polished Nickel | White Glass (PN/SLEG-WG)  
©EFC DESIGNS

**F SL2933PN/SLEG-WG**  
Polished Nickel | White Glass**F SL2933HAB/SLEG-WG**  
Hand-Rubbed Antique Brass | White Glass**F BOSTON FUNCTIONAL TRIPLE LIGHT**  
E. F. CHAPMAN

**SL2933**  
H: 9" | W: 23" | Ext: 9.5"  
Backplate: 4.5" Round  
Socket: 3 - E26 Hi-Lo | Bulb: 3 - 60 B  
**Additional Options:**  
Antique Nickel | White Glass (AN/SLEG-WG)  
Bronze | White Glass (BZ/SLEG-WG)  
Chrome | White Glass (CH/SLEG-WG)  
©EFC DESIGNS



A

AH2200PN-CG  
Polished Nickel | Crystal

A AVA SINGLE SCONCE  
ALEXA HAMPTON

AH2200  
H: 9.25" | W: 4.5" | Ext: 6"  
Backplate: 4.5" Round  
Socket: E26 Keyless | Bulb: 60 A

A

AH2200PN-CG  
Polished Nickel | Crystal

A

AH2200AN-CG  
Antique Nickel | Crystal

A

AH2200HAB-CG  
Hand-Rubbed Antique Brass | Crystal

A

AH2200BZ-CG  
Bronze | Crystal



B AVA TRIPLE SCONCE  
ALEXA HAMPTON

AH2202  
H: 9.25" | W: 20" | Ext: 6"  
Backplate: 4.5" Round  
Socket: 3 - E26 Keyless | Bulb: 3 - 60 A  
**Additional Options:**  
Antique Nickel | Crystal (AN-CG)  
Hand-Rubbed Antique Brass | Crystal (HAB-CG)

B

AH2202PN-CG  
Polished Nickel | Crystal

B

AH2202BZ-CG  
Bronze | Crystal



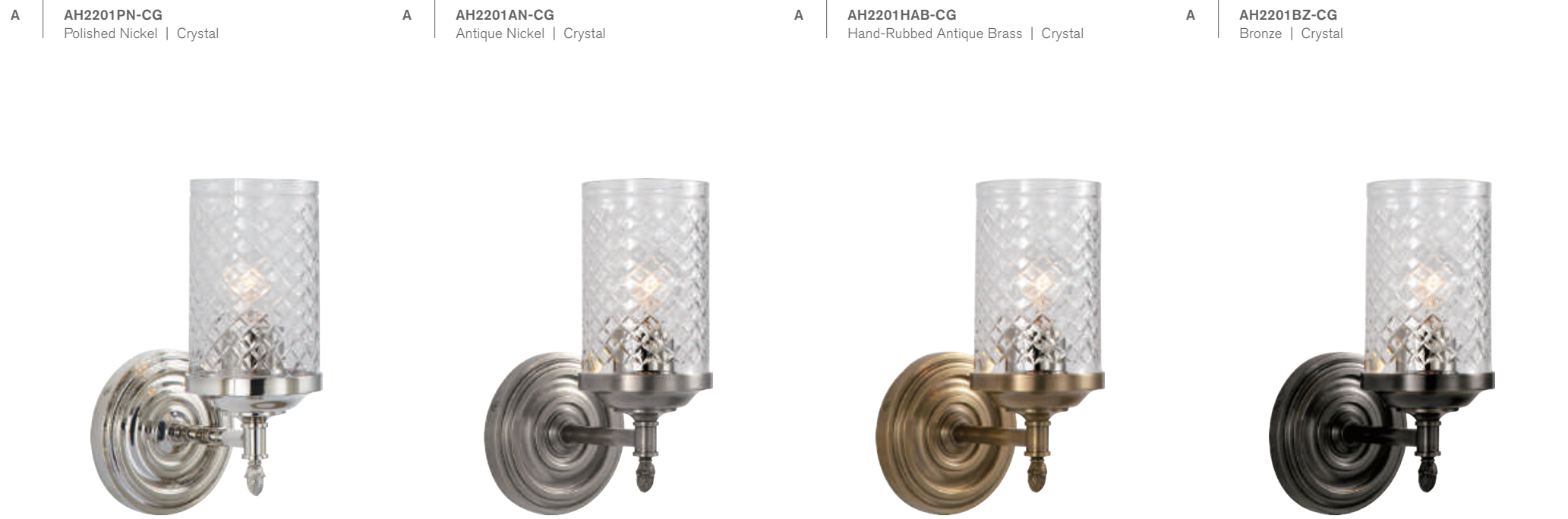

opposite page

**A** | **LITA SINGLE SCONCE**  
ALEXA HAMPTON

**AH2201**  
H: 9.5" | W: 4.5" | Ext: 6.25"  
Backplate: 4.5" Round  
Socket: E26 Keyless | Bulb: 60 A

**B** | **LITA TRIPLE SCONCE**  
ALEXA HAMPTON

**AH2203**  
H: 9.5" | W: 20" | Ext: 6.25"  
Backplate: 4.5" Round  
Socket: 3 - E26 Keyless | Bulb: 3 - 60 A  
**Additional Options:**  
Antique Nickel | Crystal (AN-CG)  
Hand-Rubbed Antique Brass | Crystal (HAB-CG)

**C** | **KS2300PN-CG**  
Polished Nickel | Crystal

**C** | **KS2300SB-CG**  
Soft Brass | Crystal

**D** | **KS2302PN-CG**  
Polished Nickel | Crystal

**D** | **KS2302SB-CG**  
Soft Brass | Crystal

**C** | **DARCY SINGLE SCONCE**  
KATE SPADE NEW YORK

**KS2300**  
H: 11" | W: 6" | Ext: 7.25"  
Backplate: 5" Round  
Socket: E12 Candelabra | Bulb: 40 B

**D** | **DARCY DOUBLE SCONCE**  
KATE SPADE NEW YORK

**KS2302**  
H: 18.5" | W: 5.5" | Ext: 6.75"  
Backplate: 5" Round  
Socket: 2 - E12 Candelabra | Bulb: 2 - 40 B

**A** | **ARN2000PW-WG**  
Plaster White | White Glass



**A** | **ARN2000BSL-WG**  
Burnished Silver Leaf | White Glass



**A** | **EDGEMERE SINGLE SCONCE**  
AERIN

**ARN2000**  
H: 16" | W: 4.5" | Ext: 8.5"  
Backplate: 4.25" Round  
Socket: E12 Candelabra | Bulb: 60 B

**B** | **ARN2013PN-WG**  
Polished Nickel | Strie Glass



**A** | **ARN2000G-WG**  
Gild | White Glass



**A** | **ARN2000BZ-WG**  
Bronze | White Glass



**B** | **ARN2013HAB-WG**  
Hand-Rubbed Antique Brass | Strie Glass



opposite page

**B** | **ROSEHILL MEDIUM LINEAR SCONCE**  
AERIN

**ARN2013**  
H: 15" | W: 6" | Ext: 4.75"  
Backplate: 4.5" x 14" Rec.  
Socket: 2 - E26 Keyless | Bulb: 2 - 60 B

**B** | **ARN2013PN-WG**  
Polished Nickel | Strie Glass



A <b>ARN2170BSL-CG</b> Burnished Silver Leaf   Crystal	A <b>ARN2170G-CG</b> Gild   Crystal	B <b>ARN2171BSL-CG</b> Burnished Silver Leaf   Crystal	B <b>ARN2171G-CG</b> Gild   Crystal
--	---	--	---



C <b>ARN2172BSL-CG</b> Burnished Silver Leaf   Crystal	C <b>ARN2172G-CG</b> Gild   Crystal
--	---



opposite page

**A LISCIA 12" SCONCE**  
AERIN**ARN2170**  
H: 12.5" | W: 6" | Ext: 4.25"  
Backplate: 4.25" x 10" Rec.  
Socket: E12 Candelabra | Bulb: 40 C**B LISCIA 22" SCONCE**  
AERIN**ARN2171**  
H: 21.75" | W: 6" | Ext: 4.25"  
Backplate: 4.25" x 19.5" Rec.  
Socket: 3 - E12 Candelabra | Bulb: 3 - 40 C**C LISCIA 23" VANITY SCONCE**  
AERIN**ARN2172**  
H: 5.75" | W: 23.25" | Ext: 5.5"  
Backplate: 4.5" x 18.5" Rec.  
Socket: 4 - E12 Candelabra | Bulb: 4 - 40 C**D SOPHIE SMALL LINEAR SCONCE**  
NIERMANN WEEKS**NW2020**  
H: 12.5" | W: 7" | Ext: 4.25"  
Backplate: 6.75" x 12.25" Rec.  
Socket: E12 Candelabra | Bulb: 60 C**E SOPHIE 18" SCONCE**  
NIERMANN WEEKS**NW2222**  
H: 18" | W: 7" | Ext: 4.25"  
Backplate: 7" x 18" Rec.  
Socket: 2 - E12 Candelabra | Bulb: 2 - 40 C**F SOPHIE WIDE SCONCE**  
NIERMANN WEEKS**NW2226**  
H: 5.5" | W: 17.5" | Ext: 4"  
Backplate: 5.5" x 17.5" Rec.  
Socket: 3 - E12 Candelabra | Bulb: 3 - 40 G

D <b>NW2020BSL</b> Burnished Silver Leaf   Glass Rods	D <b>NW2020GI</b> Gilded Iron   Glass Rods	E <b>NW2222BSL</b> Burnished Silver Leaf	E <b>NW2222GI</b> Gilded Iron
---	--	--	-------------------------------------

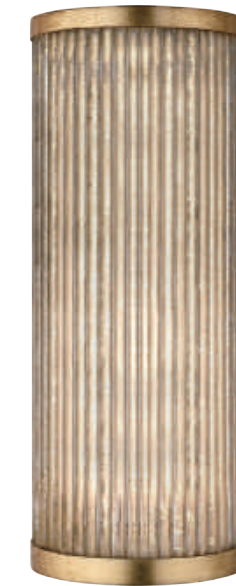

F <b>NW2226BSL</b> Burnished Silver Leaf   Glass Rods	F <b>NW2226GI</b> Gilded Iron   Glass Rods
---	--





B

KS2232BSL  
Burnished Silver Leaf | Mirror



A KEATON 18" FLORAL VANITY LIGHT  
kate spade new york

KS2231  
H: 4" | W: 18" | Ext: 4"  
Backplate: 4" x 18" Rec.  
Socket: 3 - E12 Candelabra | Bulb: 3 - 40 G

B KEATON 30" FLORAL VANITY LIGHT  
kate spade new york

KS2232  
H: 4" | W: 30" | Ext: 4"  
Backplate: 4" x 30" Rec.  
Socket: 5 - E12 Candelabra | Bulb: 5 - 40 G

C KEATON 36" FLORAL VANITY LIGHT  
kate spade new york

KS2233  
H: 4" | W: 36" | Ext: 4"  
Backplate: 4" x 36" Rec.  
Socket: 7 - E12 Candelabra | Bulb: 7 - 40 G  
Additional Options:  
Light Cream | Mirror (LC)

A KS2231LC  
Light Cream | Mirror



A KS2231BSL  
Burnished Silver Leaf | Mirror



A KS2231G  
Gild | Mirror



B KS2232LC  
Light Cream | Mirror



B KS2232G  
Gild | Mirror



C KS2233BSL  
Burnished Silver Leaf | Mirror



C KS2233G  
Gild | Mirror





OUTDOOR



OUTDOOR | FIXTURES



**A** | **S2191AI-CG**  
Aged Iron | Clear Glass



**B** | **S4190AI-CG**  
Aged Iron | Clear Glass

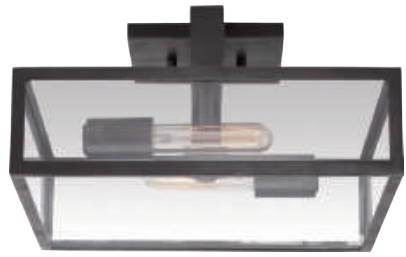

**C** | **S4191AI-CG**  
Aged Iron | Clear Glass

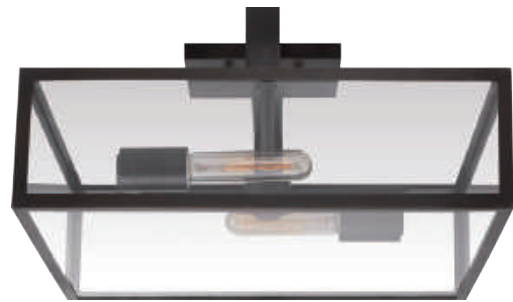

**A** | **HALLE MEDIUM WALL LANTERN**  
IAN K. FOWLER

**S2191**  
H: 18" | W: 8.75" | Ext: 8"  
Backplate: 7.5" x 12.5" Rec.  
Socket: E26 Keyless | Bulb: 60 T

**B** | **HALLE MEDIUM FLUSH MOUNT**  
IAN K. FOWLER

**S4190**  
H: 7" | W: 14" | Canopy: 6" Square  
Socket: 2 - E26 Keyless | Bulb: 2 - 40 T  
**Additional Options:**  
Polished Nickel | Clear Glass (PN-CG)

**C** | **HALLE LARGE FLUSH MOUNT**  
IAN K. FOWLER

**S4191**  
H: 7.75" | W: 17" | Canopy: 6" Square  
Socket: 2 - E26 Keyless | Bulb: 2 - 40 T  
**Additional Options:**  
Polished Nickel | Clear Glass (PN-CG)

**D** | **HALLE SMALL WALL LANTERN**  
IAN K. FOWLER

**S2190**  
H: 13.25" | W: 6.5" | Ext: 6"  
Backplate: 5" x 9" Rec.  
Socket: E12 Candelabra | Bulb: 60 T

**E** | **HALLE LARGE WALL LANTERN**  
IAN K. FOWLER

**S2192**  
H: 23" | W: 10" | Ext: 9"  
Backplate: 9.5" x 16.25" Rec.  
Socket: E26 Keyless | Bulb: 60 T

**F** | **HALLE GRANDE WALL LANTERN**  
IAN K. FOWLER

**S2193**  
H: 31" | W: 17" | Ext: 10.5"  
Backplate: 14.75" x 22" Rec.  
Socket: 2 - E26 Keyless | Bulb: 2 - 40 T

**D** | **S2190AI-CG**  
Aged Iron | Clear Glass



**E** | **S2192AI-CG**  
Aged Iron | Clear Glass



**F** | **S2193AI-CG**  
Aged Iron | Clear Glass



**G** | **S2194AI-CG**  
Aged Iron | Clear Glass



**G** | **HALLE MEDIUM WIDE WALL LANTERN**  
IAN K. FOWLER

**S2194**  
H: 18" | W: 25" | Ext: 7.5"  
Backplate: 12.5" x 23.25" Rec.  
Socket: 3 - E26 Keyless | Bulb: 3 - 40 T

**H** | **HALLE MEDIUM POST LANTERN**  
IAN K. FOWLER

**S7191**  
H: 26.76" | W: 11"  
Socket: 2 - E26 Keyless | Bulb: 2 - 40 T

**H** | **S7191AI-CG**  
Aged Iron | Clear Glass



A

**CHD2933AI-CG**  
Aged Iron | Clear Glass



B

**CHD2930AI-CG**  
Aged Iron | Clear Glass



C

**CHD2935AI-CG**  
Aged Iron | Clear Glass



D

**CHD2936AI-CG**  
Aged Iron | Clear Glass



opposite page

**A FRESNO MEDIUM FRAMED SCONCE**  
E. F. CHAPMAN

**CHD2933**  
H: 17.75" | W: 6" | Ext: 9"  
Backplate: 4.25" x 8" Rec.  
Socket: E26 Keyless | Bulb: 60 T  
©EFC DESIGNS

**B FRESNO SMALL FRAMED SCONCE**  
E. F. CHAPMAN

**CHD2930**  
H: 10.5" | W: 5" | Ext: 8"  
Backplate: 4.25" x 6" Rec.  
Socket: E26 Keyless | Bulb: 60 A  
©EFC DESIGNS

**C FRESNO LARGE FRAMED SCONCE**  
E. F. CHAPMAN

**CHD2935**  
H: 21.75" | W: 6" | Ext: 9"  
Backplate: 4.25" x 12" Rec.  
Socket: E26 Keyless | Bulb: 60 T  
©EFC DESIGNS

**D FRESNO GRANDE FRAMED SCONCE**  
E. F. CHAPMAN

**CHD2936**  
H: 29.75" | W: 9" | Ext: 12"  
Backplate: 4.25" x 12" Rec.  
Socket: E26 Keyless | Bulb: 60 T  
©EFC DESIGNS

**E FRESNO SMALL FRAMED FLUSH MOUNT**  
E. F. CHAPMAN

**CHC4033**  
H: 4.25" | W: 8" | Canopy: 7" Square  
Socket: 2 - E26 Keyless | Bulb: 2 - 40 T  
©EFC DESIGNS

**F FRESNO MEDIUM FRAMED FLUSH MOUNT**  
E. F. CHAPMAN

**CHC4035**  
H: 4.25" | W: 12" | Canopy: 11" Square  
Socket: 2 - E26 Keyless | Bulb: 2 - 40 T  
©EFC DESIGNS

**G FRESNO SMALL FRAMED SEMI-FLUSH MOUNT**  
E. F. CHAPMAN

**CHC4036**  
H: 11.5" | W: 5" | Canopy: 4.25" Square  
Socket: E26 Keyless | Bulb: 40 T  
©EFC DESIGNS

E

**CHC4033CH-CG**  
Chrome | Clear Glass



E

**CHC4033AI-CG**  
Aged Iron | Clear Glass



F

**CHC4035CH-CG**  
Chrome | Clear Glass



F

**CHC4035AI-CG**  
Aged Iron | Clear Glass

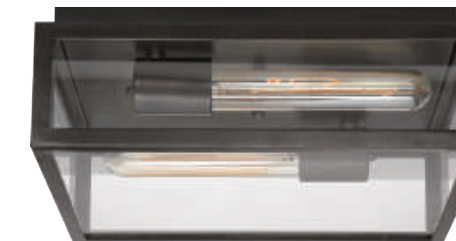

G

**CHC4036CH-CG**  
Chrome | Clear Glass



G

**CHC4036AI-CG**  
Aged Iron | Clear Glass



**A** | **KW2123AB-CRG**  
Antique Burnished Brass | Crackle Glass



**A** | **KW2123BZ-CRG**  
Bronze | Crackle Glass



**B** | **CHO2018BZ-CG**  
Bronze | Clear Glass



**B** | **CHO2018AB-CG**  
Antique-Burnished Brass | Clear Glass



opposite page  
**A** | **LIAISON LARGE BRACKETED WALL SCONCE**  
KELLY WEARSTLER  
**KW2123**  
H: 20" | W: 4.75" | Ext: 8"  
Backplate: 3.5" x 20" Rec.  
Socket: E12 Candelabra | Bulb: 60 C  
**Additional Options:**  
Polished Nickel | Crackle Glass (PN-CRG)

**C** | **CHO2017AB-CG**  
Antique-Burnished Brass | Clear Glass



**C** | **CHO2017BZ-CG**  
Bronze | Clear Glass



**B** | **CHO2018BZ-CG**  
Bronze | Clear Glass



**B** | **DUNMORE TALL WALL LANTERN**  
E. F. CHAPMAN  
**CHO2018**  
H: 19.5" | W: 7" | Ext: 4.25"  
Backplate: 5" x 19" Rec.  
Socket: 2 - E17 Keyless | Bulb: 2 - 40 T  
**Additional Options:**  
Polished Nickel | Clear Glass (PN-CG)  
©EFC DESIGNS

**C** | **DUNMORE SMALL WALL LANTERN**  
E. F. CHAPMAN  
**CHO2017**  
H: 13.25" | W: 7.75" | Ext: 4.5"  
Backplate: 6" x 13" Rec.  
Socket: E17 Keyless | Bulb: 40 T  
**Additional Options:**  
Polished Nickel | Clear Glass (PN-CG)  
©EFC DESIGNS

**D** | **DUNMORE LARGE WALL LANTERN**  
E. F. CHAPMAN  
**CHO2019**  
H: 23" | W: 11.25" | Ext: 3.25"  
Backplate: 8.75" x 22.75" Rec.  
Socket: 2 - E17 Keyless | Bulb: 2 - 40 T  
**Additional Options:**  
Polished Nickel | Clear Glass (PN-CG)  
©EFC DESIGNS

**D** | **CHO2019AB-CG**  
Antique-Burnished Brass | Clear Glass



**D** | **CHO2019BZ-CG**  
Bronze | Clear Glass



A

**CHO2792BZ-CG**  
Bronze | Clear Glass



A

**DARLANA LARGE TALL 3/4 WALL LANTERN**  
E. F. CHAPMAN

**CHO2792**  
H: 27.75" | W: 11.5" | Ext: 10"  
Backplate: 10.25" x 20.75" Rec.  
Socket: 3 - E12 Candelabra | Bulb: 3 - 60 C  
©EFC DESIGNS

B

**DARLANA SMALL BRACKET WALL LANTERN**  
E. F. CHAPMAN

**CHO2085**  
H: 21.25" | W: 12.5" | Ext: 14.25"  
Backplate: 4" x 13" Rec.  
Socket: 4 - E12 Candelabra | Bulb: 4 - 40 C  
©EFC DESIGNS

B

**CHO2085BZ**  
Bronze | Clear Glass



C

**CHO5084BZ**  
Bronze | Clear Glass



E

**CHO2043BZ**  
Bronze | Clear Glass



D

**CHO5085BZ**  
Bronze | Clear Glass



F

**CHO2044BZ**  
Bronze | Clear Glass



C

**DARLANA SMALL HANGING LANTERN**  
E. F. CHAPMAN

**CHO5084**  
H: 18.5" | W: 12.5" | Canopy: 6" Round  
Socket: 4 - E12 Candelabra | Bulb: 4 - 40 C  
©EFC DESIGNS

D

**DARLANA MEDIUM HANGING LANTERN**  
E. F. CHAPMAN

**CHO5085**  
H: 24.5" | W: 17" | Canopy: 6" Round  
Socket: 4 - E12 Candelabra | Bulb: 4 - 60 C  
©EFC DESIGNS

E



**DARLANA MEDIUM BRACKET WALL LANTERN**  
E. F. CHAPMAN

**CHO2043**  
H: 28.25" | W: 17" | Ext: 19"  
Backplate: 4.5" x 17.25" Rec.  
Socket: 4 - E12 Candelabra | Bulb: 4 - 60 C  
©EFC DESIGNS

F

**DARLANA LARGE BRACKET WALL LANTERN**  
E. F. CHAPMAN

**CHO2044**  
H: 39" | W: 24.5" | Ext: 26.5"  
Backplate: 5" x 23.75" Rec.  
Socket: 6 - E12 Candelabra | Bulb: 6 - 60 C  
©EFC DESIGNS

<p><b>A</b>    <b>CHO2086BZ</b> Bronze   Clear Glass</p> 	<p><b>B</b>    <b>CHO2788BZ-CG</b> Bronze   Clear Glass</p> 
--	---

**A**    **DARLANA NARROW BRACKET WALL LANTERN**  
E. F. CHAPMAN

**CHO2086**  
H: 21.25" | W: 7.5" | Ext: 9.75"  
Backplate: 4" x 13" Rec.  
Socket: 2 - E12 Candelabra | Bulb: 2 - 60 C  
©EFC DESIGNS

**B**    **DARLANA MEDIUM TALL BRACKET WALL LANTERN**  
E. F. CHAPMAN





**CHO2788**  
H: 27" | W: 9.75" | Ext: 12"  
Backplate: 4" x 16.5" Rec.  
Socket: 3 - E12 Candelabra | Bulb: 3 - 60 C  
\* Finish Will Patina in Full Weather  
\* Extreme Conditions May Deteriorate Finish  
©EFC DESIGNS

**C**    **DARLANA LARGE TALL BRACKET WALL LANTERN**  
E. F. CHAPMAN

**CHO2789**  
H: 31.5" | W: 11.5" | Ext: 14"  
Backplate: 4" x 19.25" Rec.  
Socket: 3 - E12 Candelabra | Bulb: 3 - 60 C  
\* Finish Will Patina in Full Weather  
\* Extreme Conditions May Deteriorate Finish  
©EFC DESIGNS

**E**    **CHO2087BZ**  
Bronze | Clear Glass



<p><b>G</b>    <b>CHO2045BZ-CG</b> Bronze   Clear Glass</p> 	<p><b>H</b>    <b>CHO2040BZ</b> Bronze   Clear Glass</p> 	<p><b>I</b>    <b>CHO2084BZ</b> Bronze   Clear Glass</p> 	<p><b>J</b>    <b>CHO2791BZ-CG</b> Bronze   Clear Glass</p> 
---	--	--	---

**G**    **DARLANA MINI 3/4 WALL LANTERN**  
E. F. CHAPMAN

**CHO2045**  
H: 10" | W: 6.5" | Ext: 6"  
Backplate: 5.5" x 7" Trapezoid  
Socket: E12 Candelabra | Bulb: 60 C  
©EFC DESIGNS

**H**    **DARLANA SMALL 3/4 WALL LANTERN**  
E. F. CHAPMAN

**CHO2040**  
H: 14" | W: 9.75" | Ext: 7.25"  
Backplate: 9.25" x 10.25" Trapezoid  
Socket: 2 - E12 Candelabra | Bulb: 2 - 60 C  
©EFC DESIGNS

**I**    **DARLANA MEDIUM 3/4 WALL LANTERN**  
E. F. CHAPMAN

**CHO2084**  
H: 18.5" | W: 12.5" | Ext: 9.25"  
Backplate: 8.75" x 11.75" Trapezoid  
Socket: 3 - E12 Candelabra | Bulb: 3 - 60 C  
©EFC DESIGNS

**J**    **DARLANA MEDIUM TALL 3/4 WALL LANTERN**  
E. F. CHAPMAN

**CHO2791**  
H: 23.5" | W: 9.75" | Ext: 9"  
Backplate: 8.75" x 17.75" Rec.  
Socket: 2 - E12 Candelabra | Bulb: 2 - 60 C  
©EFC DESIGNS

<p><b>C</b>    <b>CHO2789BZ-CG</b> Bronze   Clear Glass</p> 	<p><b>D</b>    <b>CHO2790BZ-CG</b> Bronze   Clear Glass</p> 
--	--

**D**    **DARLANA GRANDE TALL BRACKET WALL LANTERN**  
E. F. CHAPMAN

**CHO2790**  
H: 38.25" | W: 13.5" | Ext: 17"  
Backplate: 4" x 23.75" Rec.  
Socket: 3 - E12 Candelabra | Bulb: 3 - 60 C  
©EFC DESIGNS

**E**    **DARLANA NARROW 3/4 WALL LANTERN**  
E. F. CHAPMAN



**CHO2087**  
H: 18.5" | W: 7.5" | Ext: 6.75"  
Backplate: 6.75" x 13.5" Rec.  
Socket: 2 - E12 Candelabra | Bulb: 2 - 60 C  
©EFC DESIGNS

**F**    **DARLANA POST LIGHT**  
E. F. CHAPMAN

**CHO7113**  
H: 31" | W: 17" | Base: 3" Round Post Cap  
Socket: 4 - E12 Candelabra | Bulb: 4 - 60 C  
©EFC DESIGNS

**F**    **CHO7113BZ**  
Bronze | Clear Glass



<p><b>K</b>    <b>CHO2041BZ</b> Bronze   Clear Glass</p> 	<p><b>L</b>    <b>CHO2042BZ</b> Bronze   Clear Glass</p> 
---	---

**K**    **DARLANA LARGE 3/4 WALL LANTERN**  
E. F. CHAPMAN

**CHO2041**  
H: 24.5" | W: 17" | Ext: 12.25"  
Backplate: 16" x 18.25" Trapezoid  
Socket: 3 - E12 Candelabra | Bulb: 3 - 60 C  
©EFC DESIGNS

**L**    **DARLANA GRANDE 3/4 WALL LANTERN**  
E. F. CHAPMAN

**CHO2042**  
H: 34" | W: 24.5" | Ext: 16.5"  
Backplate: 23" x 25.75" Trapezoid  
Socket: 3 - E12 Candelabra | Bulb: 3 - 60 C  
©EFC DESIGNS



**A** **CHELSEA MEDIUM HANGING LANTERN**  
E. F. CHAPMAN

**CHO5003**  
H: 20.5" | W: 9" | Canopy: 5.5" Round  
Socket: 3 - E12 Candelabra | Bulb: 3 - 60 C  
©EFC DESIGNS

**B** **CHELSEA LARGE WALL LANTERN**  
E. F. CHAPMAN

**CHO2112**  
H: 31.5" | W: 12" | Ext: 18.5"  
Backplate: 5.5" x 7"  
Socket: 3 - E12 Candelabra | Bulb: 3-40 C  
©EFC DESIGNS

**B** **CHO2112BZ**  
Bronze | Clear Glass



**A** **CHO5003BZ**  
Bronze | Clear Glass

**C** **CHELSEA SMALL 3/4 WALL LANTERN**  
E. F. CHAPMAN

**CHO2109**  
H: 14" | W: 7" | Ext: 7.5"  
Socket: E12 Candelabra | Bulb: 60 C  
©EFC DESIGNS

**D** **CHELSEA SMALL WALL LANTERN**  
E. F. CHAPMAN

**CHO2110**  
H: 18.5" | W: 7" | Ext: 11.75"  
Backplate: 4" x 5.5"  
Socket: E12 Candelabra | Bulb: 40 C  
©EFC DESIGNS

**E** **CHELSEA MEDIUM WALL LANTERN**  
E. F. CHAPMAN

**CHO2111**  
H: 24.5" | W: 9" | Ext: 15.25"  
Backplate: 4" x 6"  
Socket: 3 - E12 Candelabra | Bulb: 3-40 C  
©EFC DESIGNS

**C** **CHO2109BZ**  
Bronze | Clear Glass



**D** **CHO2110BZ**  
Bronze | Clear Glass



**E** **CHO2111BZ**  
Bronze | Clear Glass



**F** **CHELSEA LARGE SCROLL ARM WALL LANTERN**  
E. F. CHAPMAN

**CHO2113**  
H: 31" | W: 9.25" | Ext: 13.25"  
Backplate: 4.75" x 9"  
Socket: 3 - E12 Candelabra | Bulb: 3-40 C  
©EFC DESIGNS

**G** **CHELSEA MEDIUM POST LANTERN**  
E. F. CHAPMAN

**CHO7110**  
H: 23.75" | W: 9" | Base: 3" Round Post Cap  
Socket: 3 - E12 Candelabra | Bulb: 3 - 60 C  
©EFC DESIGNS

**H** **CHELSEA LARGE POST LANTERN**  
E. F. CHAPMAN

**CHO7111**  
H: 29.5" | W: 12" | Base: 3" Round Post Cap  
Socket: 3 - E12 Candelabra | Bulb: 3 - 60 C  
©EFC DESIGNS

**F** **CHO2113BZ**  
Bronze | Clear Glass



**G** **CHO7110BZ**  
Bronze | Clear Glass



**H** **CHO7111BZ**  
Bronze | Clear Glass



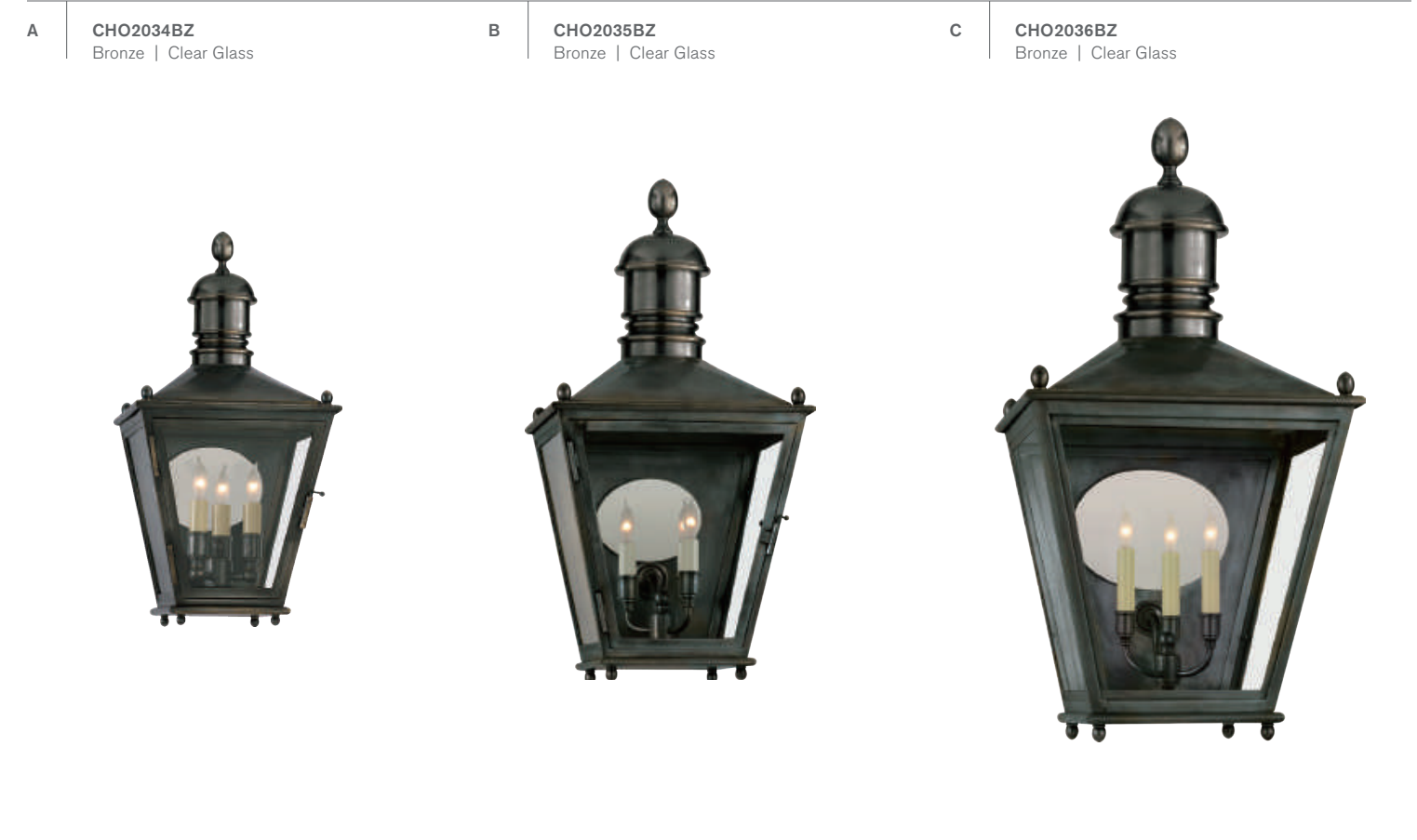

**A SUSSEX SMALL 3/4 WALL LANTERN**  
E. F. CHAPMAN  
  
**CHO2034**  
H: 19" | W: 9.5" | Ext: 8.25"  
Socket: 3 - E12 Candelabra | Bulb: 3 - 60 C  
©EFC DESIGNS

**B SUSSEX MEDIUM 3/4 WALL LANTERN**  
E. F. CHAPMAN  
  
**CHO2035**  
H: 24" | W: 12" | Ext: 11"  
Socket: 3 - E12 Candelabra | Bulb: 3 - 60 C  
©EFC DESIGNS

**C SUSSEX LARGE 3/4 WALL LANTERN**  
E. F. CHAPMAN  
  
**CHO2036**  
H: 31" | W: 16" | Ext: 14.5"  
Socket: 3 - E12 Candelabra | Bulb: 3 - 60 C  
©EFC DESIGNS

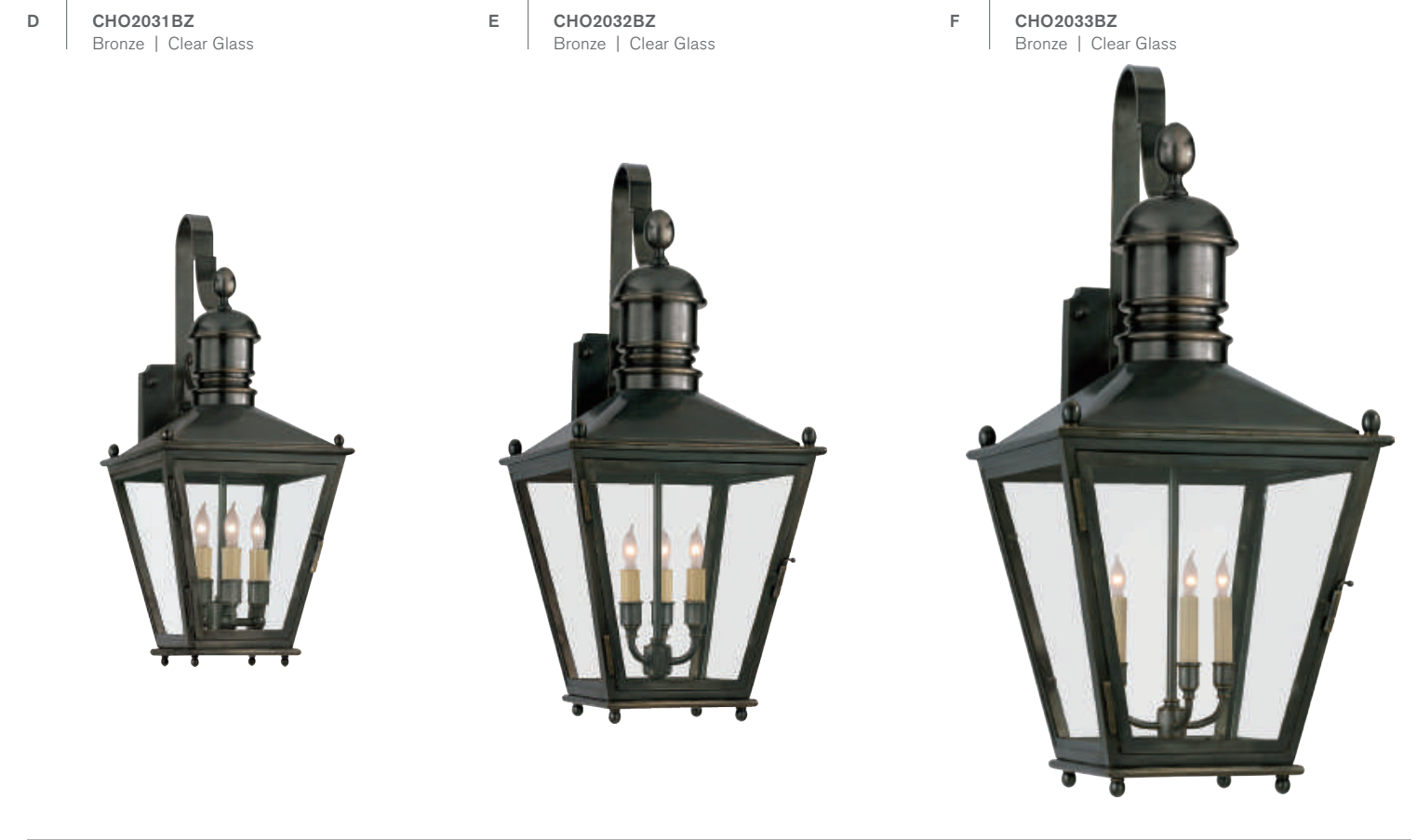

**D SUSSEX SMALL BRACKET WALL LANTERN**  
E. F. CHAPMAN  
  
**CHO2031**  
H: 22.25" | W: 9.5" | Ext: 11.5"  
Backplate: 4.5" x 5"  
Socket: 3 - E12 Candelabra | Bulb: 3 - 60 C  
©EFC DESIGNS

**E SUSSEX MEDIUM BRACKET WALL LANTERN**  
E. F. CHAPMAN  
  
**CHO2032**  
H: 27.25" | W: 12.25" | Ext: 13"  
Backplate: 4.5" x 6"  
Socket: 3 - E12 Candelabra | Bulb: 3 - 60 C  
©EFC DESIGNS

**F SUSSEX LARGE BRACKET WALL LANTERN**  
E. F. CHAPMAN  
  
**CHO2033**  
H: 36" | W: 16" | Ext: 17"  
Backplate: 7" x 5"  
Socket: 3 - E12 Candelabra | Bulb: 3 - 60 C  
©EFC DESIGNS

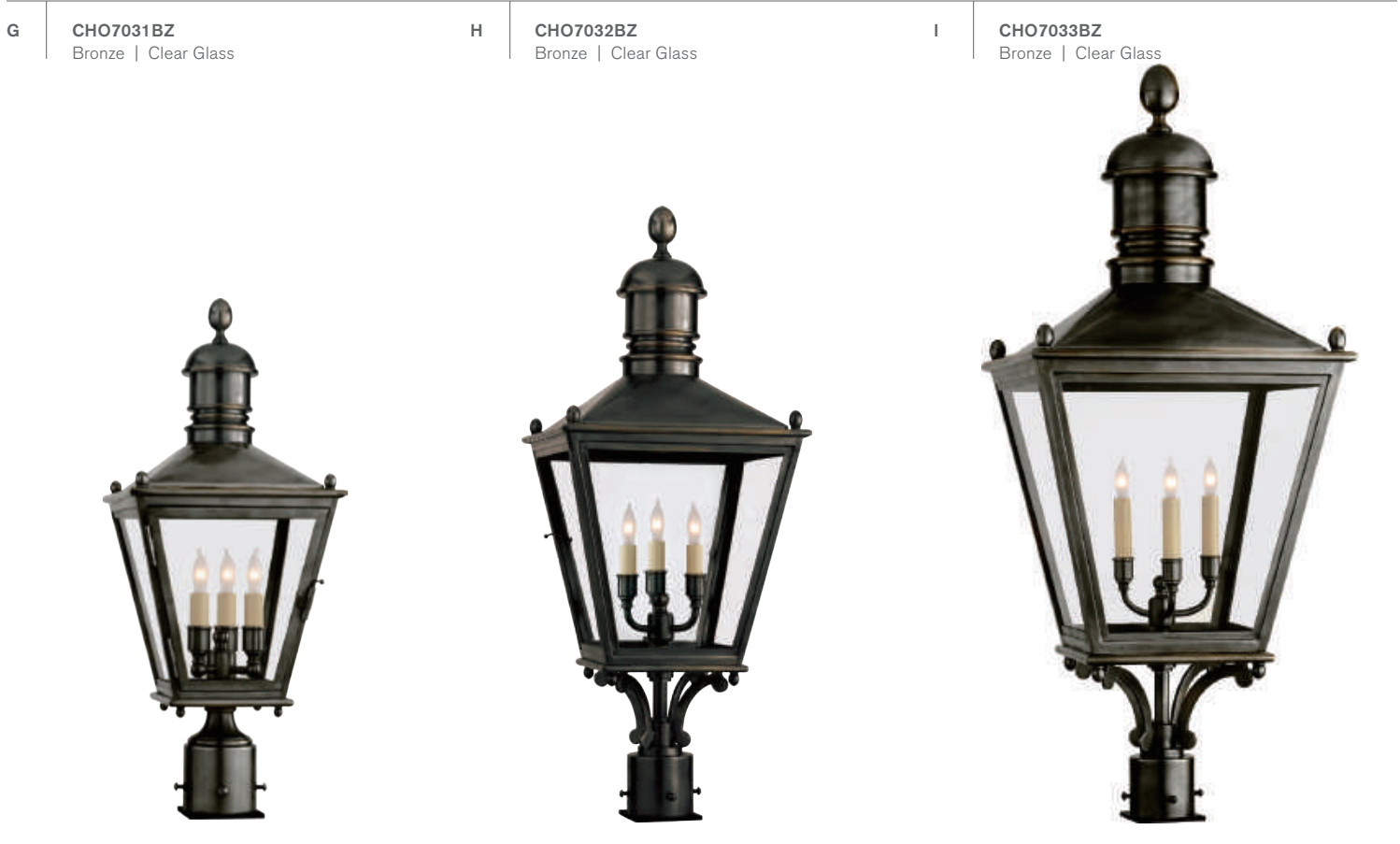

**G SUSSEX SMALL POST LANTERN**  
E. F. CHAPMAN  
  
**CHO7031**  
H: 23.5" | W: 9.5" | Base: 3" Round Post Cap  
Socket: 3 - E12 Candelabra | Bulb: 3 - 60 C  
©EFC DESIGNS

**H SUSSEX MEDIUM POST LANTERN**  
E. F. CHAPMAN  
  
**CHO7032**  
H: 30.25" | W: 12.25" | Base: 3" Round Post Cap  
Socket: 3 - E12 Candelabra | Bulb: 3 - 60 C  
©EFC DESIGNS

**I SUSSEX LARGE POST LANTERN**  
E. F. CHAPMAN  
  
**CHO7033**  
H: 37.75" | W: 16" | Base: 3" Round Post Cap  
Socket: 3 - E12 Candelabra | Bulb: 3 - 60 C  
©EFC DESIGNS

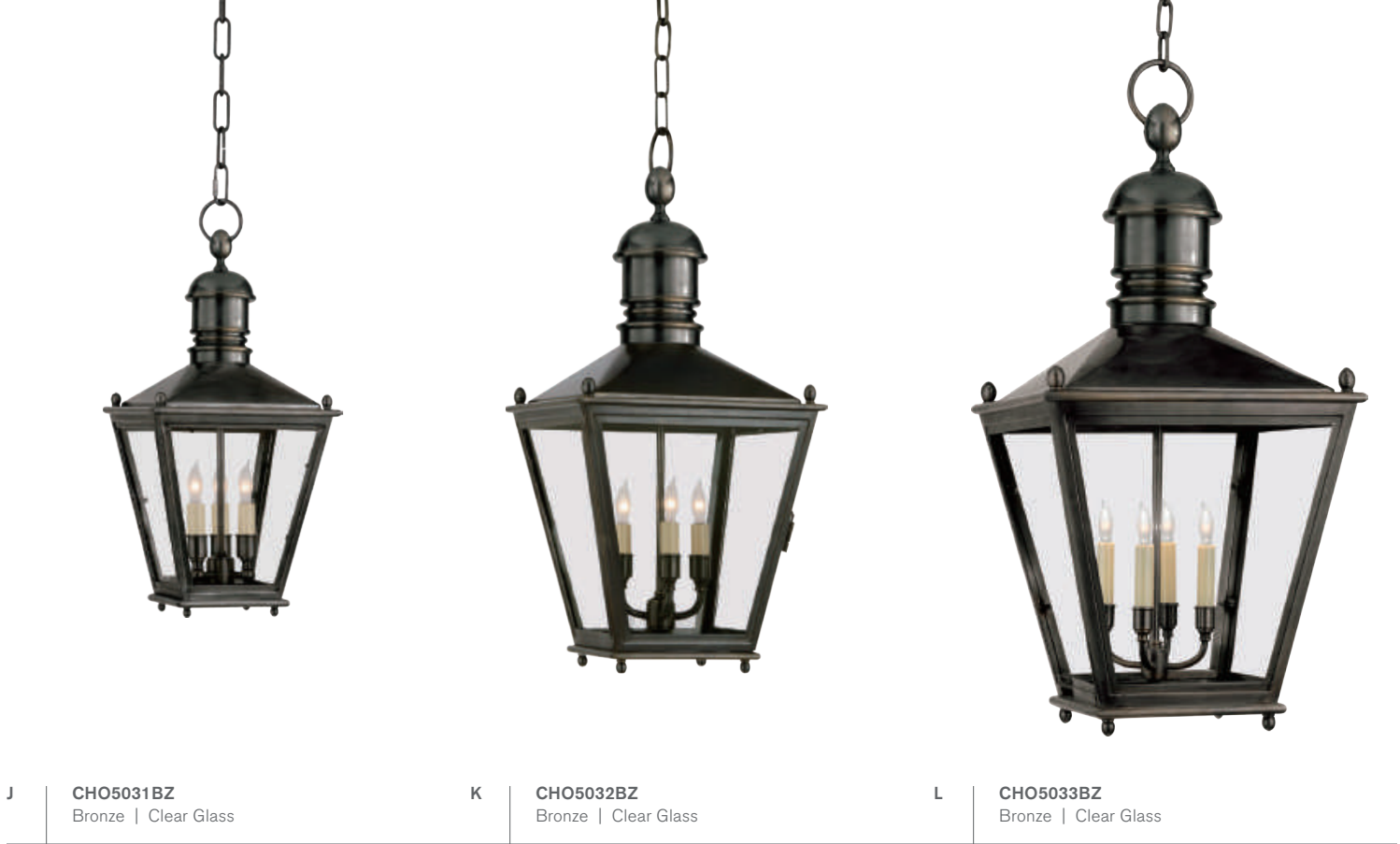

**J SUSSEX SMALL HANGING LANTERN**  
E. F. CHAPMAN  
  
**CHO5031**  
H: 20.5" | W: 9.5" | Canopy: 5.5" Round  
Socket: 3 - E12 Candelabra | Bulb: 3 - 60 C  
©EFC DESIGNS

**K SUSSEX MEDIUM HANGING LANTERN**  
E. F. CHAPMAN  
  
**CHO5032**  
H: 26" | W: 12.25" | Canopy: 5.5" Round  
Socket: 3 - E12 Candelabra | Bulb: 3 - 60 C  
©EFC DESIGNS

**L SUSSEX LARGE HANGING LANTERN**  
E. F. CHAPMAN  
  
**CHO5033**  
H: 33" | W: 16" | Canopy: 5.5" Round  
Socket: 4 - E12 Candelabra | Bulb: 4 - 60 C  
©EFC DESIGNS

**A** **CHD2907AB-CG**  
Antique-Burnished Brass

**A** **CHD2907WZ-CG**  
Weathered Zinc

**B** **CHO2908AB**  
Antique-Burnished Brass | Clear Glass

**B** **CHO2908WZ**  
Weathered Zinc | Clear Glass



**A** **LINEAR MINI WALL LANTERN**  
E. F. CHAPMAN

**CHD2907**  
H: 12" | W: 5" | Ext: 5"  
Backplate: 4.75" x 7.75" Rec.  
Socket: 2 - E12 Candelabra | Bulb: 2 - 40 C  
**Additional Options:**  
Bronze (BZ-CG)  
©EFC DESIGNS

**B** **LINEAR LANTERN SHORT**  
E. F. CHAPMAN

**CHO2908**  
H: 15" | W: 9" | Ext: 5"  
Backplate: 9" x 13" Rec.  
Socket: 2 - E12 Candelabra | Bulb: 2 - 60 C  
©EFC DESIGNS

**C** **CHO2908BZ**  
Bronze | Clear Glass



**C** **CHO2910AB**  
Antique-Burnished Brass | Clear Glass

**C** **CHO2910BZ**  
Bronze | Clear Glass

**D** **CHD2911AB-CG**  
Antique-Burnished Brass | Clear Glass

**D** **CHD2911BZ-CG**  
Bronze | Clear Glass



**C** **LINEAR LANTERN TALL**  
E. F. CHAPMAN

**CHO2910**  
H: 22.5" | W: 9" | Ext: 5"  
Backplate: 9" x 20" Rec.  
Socket: 2 - E12 Candelabra | Bulb: 2 - 60 C  
**Additional Options:**  
Weathered Zinc | Clear Glass (WZ-CG)  
©EFC DESIGNS

**D** **LINEAR LARGE WALL LANTERN**  
E. F. CHAPMAN

**CHD2911**  
H: 29" | W: 9" | Ext: 5"  
Backplate: 8.5" x 19.75" Rec.  
Socket: 2 - E12 Candelabra | Bulb: 2 - 60 C  
**Additional Options:**  
Weathered Zinc | Clear Glass (WZ-CG)  
©EFC DESIGNS

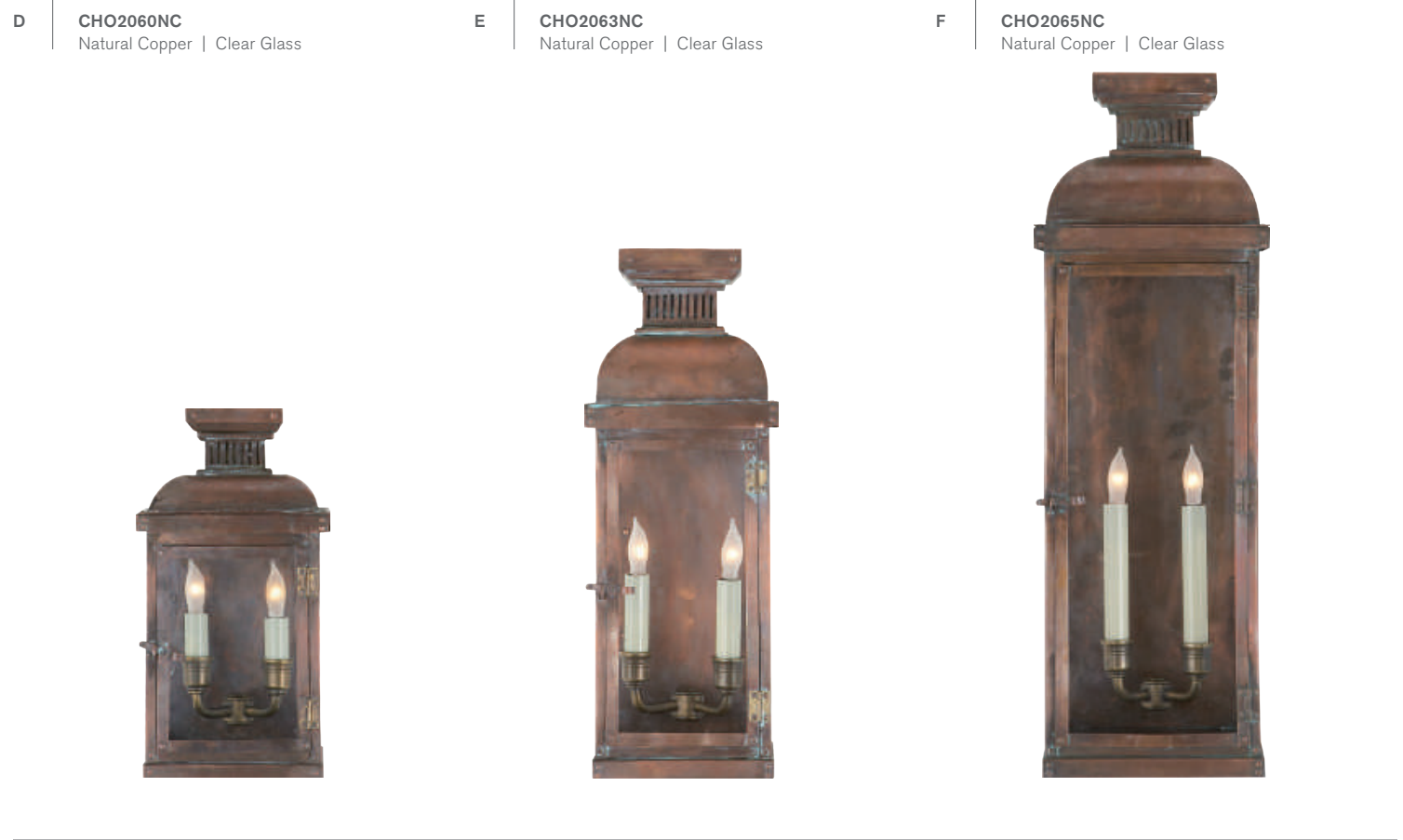
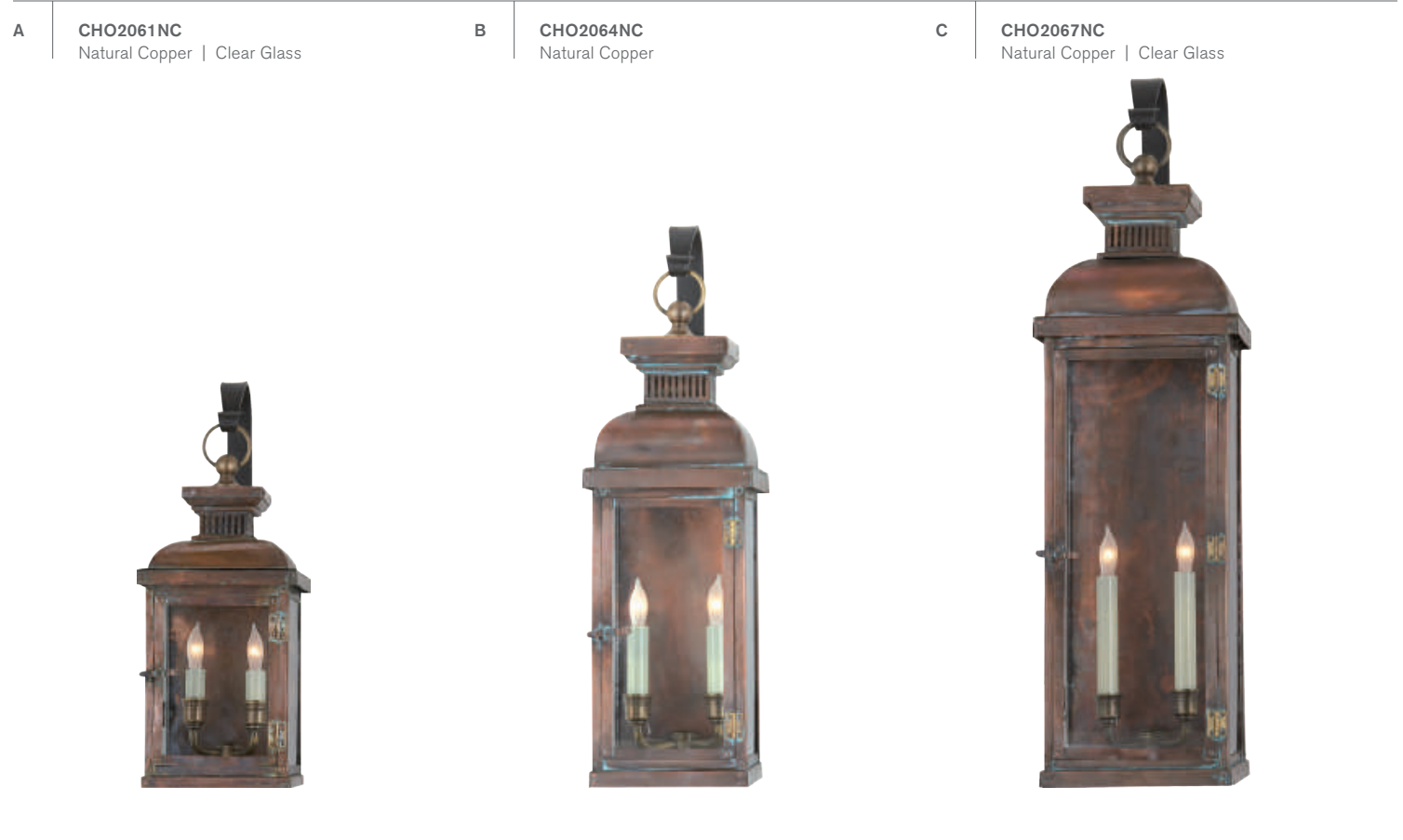

**A SUFFORK SMALL SCROLL ARM WALL LANTERN**  
E. F. CHAPMAN

**CHO2061**  
H: 17.75" | W: 6.75" | Ext: 7.5"  
Backplate: 4.5" Square  
Socket: 2 - E12 Candelabra | Bulb: 2 - 60 C  
©EFC DESIGNS

**B SUFFORK MEDIUM SCROLL ARM WALL LANTERN**  
E. F. CHAPMAN

**CHO2064**  
H: 22.25" | W: 6.75" | Ext: 7.5"  
Backplate: 4.5" x 5"  
Socket: 2 - E12 Candelabra | Bulb: 2 - 60 C  
©EFC DESIGNS

**C SUFFORK LARGE SCROLL ARM WALL LANTERN**  
E. F. CHAPMAN

**CHO2067**  
H: 29.25" | W: 8" | Ext: 7.5"  
Backplate: 4.5" x 5"  
Socket: 2 - E12 Candelabra | Bulb: 2 - 60 C  
©EFC DESIGNS

**D SUFFORK SMALL 3/4 WALL LANTERN**  
E. F. CHAPMAN

**CHO2060**  
H: 12.25" | W: 6.75" | Ext: 6"  
Backplate: 5.5" x 5.25"  
Socket: 2 - E12 Candelabra | Bulb: 2 - 60 C  
©EFC DESIGNS

**E SUFFORK MEDIUM 3/4 WALL LANTERN**  
E. F. CHAPMAN

**CHO2063**  
H: 18" | W: 6.75" | Ext: 6"  
Backplate: 5.25" x 11"  
Socket: 2 - E12 Candelabra | Bulb: 2 - 60 C  
©EFC DESIGNS

**F SUFFORK LARGE 3/4 WALL LANTERN**  
E. F. CHAPMAN

**CHO2065**  
H: 24" | W: 8" | Ext: 6"  
Backplate: 6.5" x 14.75"  
Socket: 2 - E12 Candelabra | Bulb: 2 - 60 C  
©EFC DESIGNS



**B CHO2064NC**  
Natural Copper | Clear Glass

**G SUFFORK POST LANTERN**  
E. F. CHAPMAN

**CHO7821**  
H: 24.25" | W: 9.75" | Base: 3" Round Post Cap  
Socket: 4 - E12 Candelabra | Bulb: 4 - 40 C  
**Additional Options:**  
Weathered Zinc | Clear Glass (WZ-CG)  
©EFC DESIGNS



**G CHO7821NC-CG**  
Natural Copper | Clear Glass

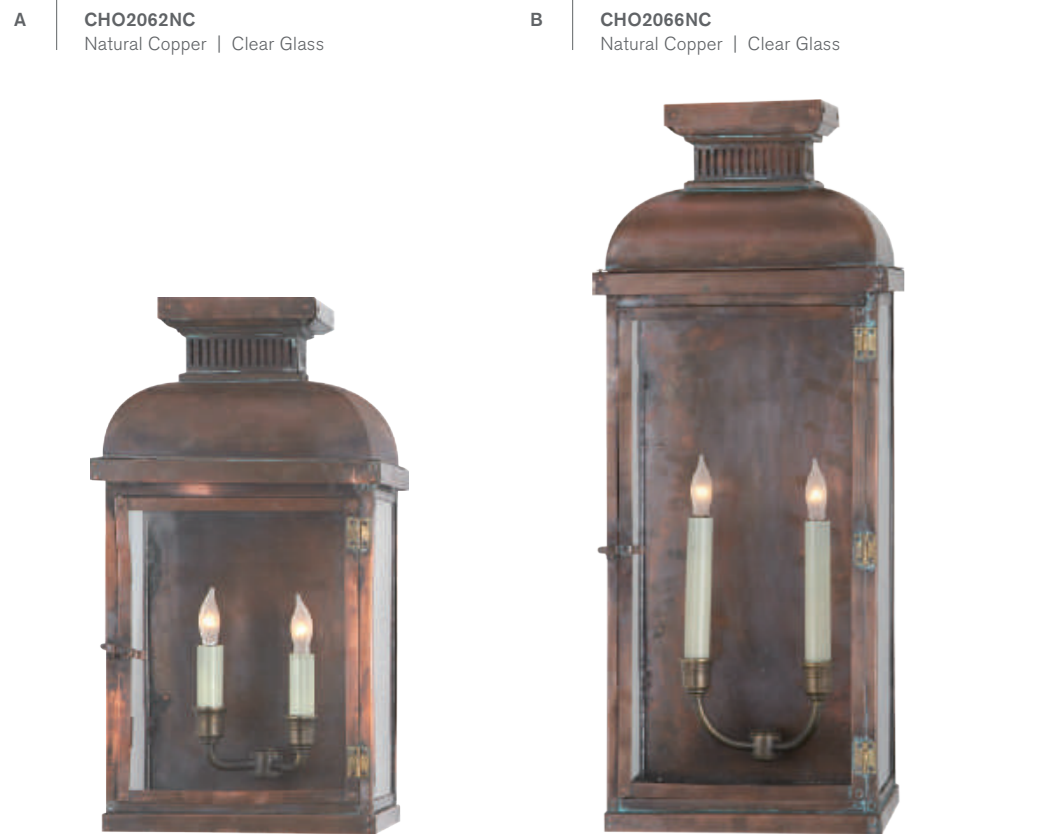

**A** **CHO2062NC**  
Natural Copper | Clear Glass

**B** **CHO2066NC**  
Natural Copper | Clear Glass

**A** **SUFFORK MEDIUM WIDE 3/4 WALL LANTERN**  
E. F. CHAPMAN

**CHO2062**  
H: 18" | W: 9.75" | Ext: 6"  
Backplate: 8.25" x 8.75"  
Socket: 2 - E12 Candelabra | Bulb: 2 - 60 C  
©EFC DESIGNS

**B** **SUFFORK LARGE WIDE 3/4 WALL LANTERN**  
E. F. CHAPMAN

**CHO2066**  
H: 24" | W: 9.75" | Ext: 6"  
Backplate: 8.25" x 14.75"  
Socket: 2 - E12 Candelabra | Bulb: 2 - 60 C  
©EFC DESIGNS

**E** **BEDFORD POST LANTERN**  
E. F. CHAPMAN

**CHO7820**  
H: 24.5" | W: 10" | Base: 3" Round Post Cap  
Socket: 4 - E12 Candelabra | Bulb: 4 - 40 C  
**Additional Options:**  
Weathered Zinc | Clear Glass (WZ-CG)  
©EFC DESIGNS

**F** **BEDFORD SMALL BRACKET WALL LANTERN**  
E. F. CHAPMAN

**CHO2151**  
H: 16.5" | W: 6.75" | Ext: 7.5"  
Backplate: 4.5" Square  
Socket: 2 - E12 Candelabra | Bulb: 2 - 60 C  
©EFC DESIGNS

**G** **BEDFORD MEDIUM BRACKET WALL LANTERN**  
E. F. CHAPMAN

**CHO2153**  
H: 22.5" | W: 6.75" | Ext: 7.5"  
Backplate: 4.5" x 5"  
Socket: 2 - E12 Candelabra | Bulb: 2 - 60 C  
©EFC DESIGNS

**H** **BEDFORD LARGE BRACKET WALL LANTERN**  
E. F. CHAPMAN

**CHO2155**  
H: 29.25" | W: 8" | Ext: 7.5"  
Backplate: 4.5" x 5.5"  
Socket: 2 - E12 Candelabra | Bulb: 2 - 60 C  
©EFC DESIGNS

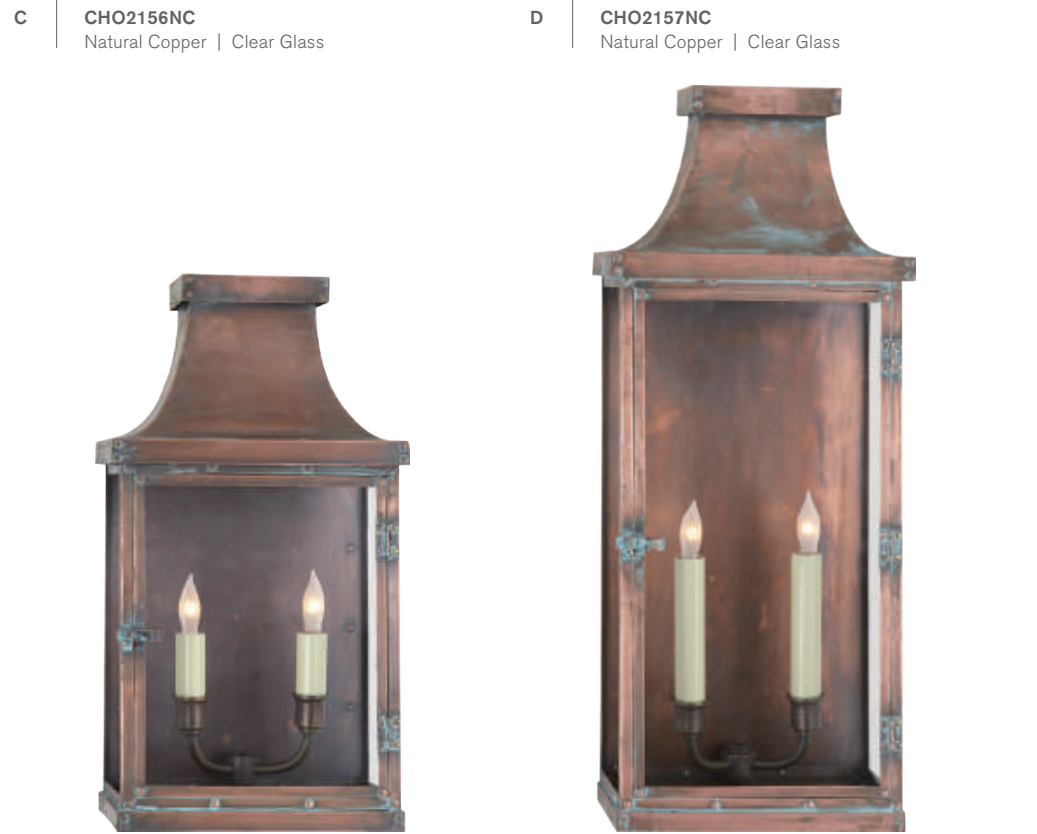
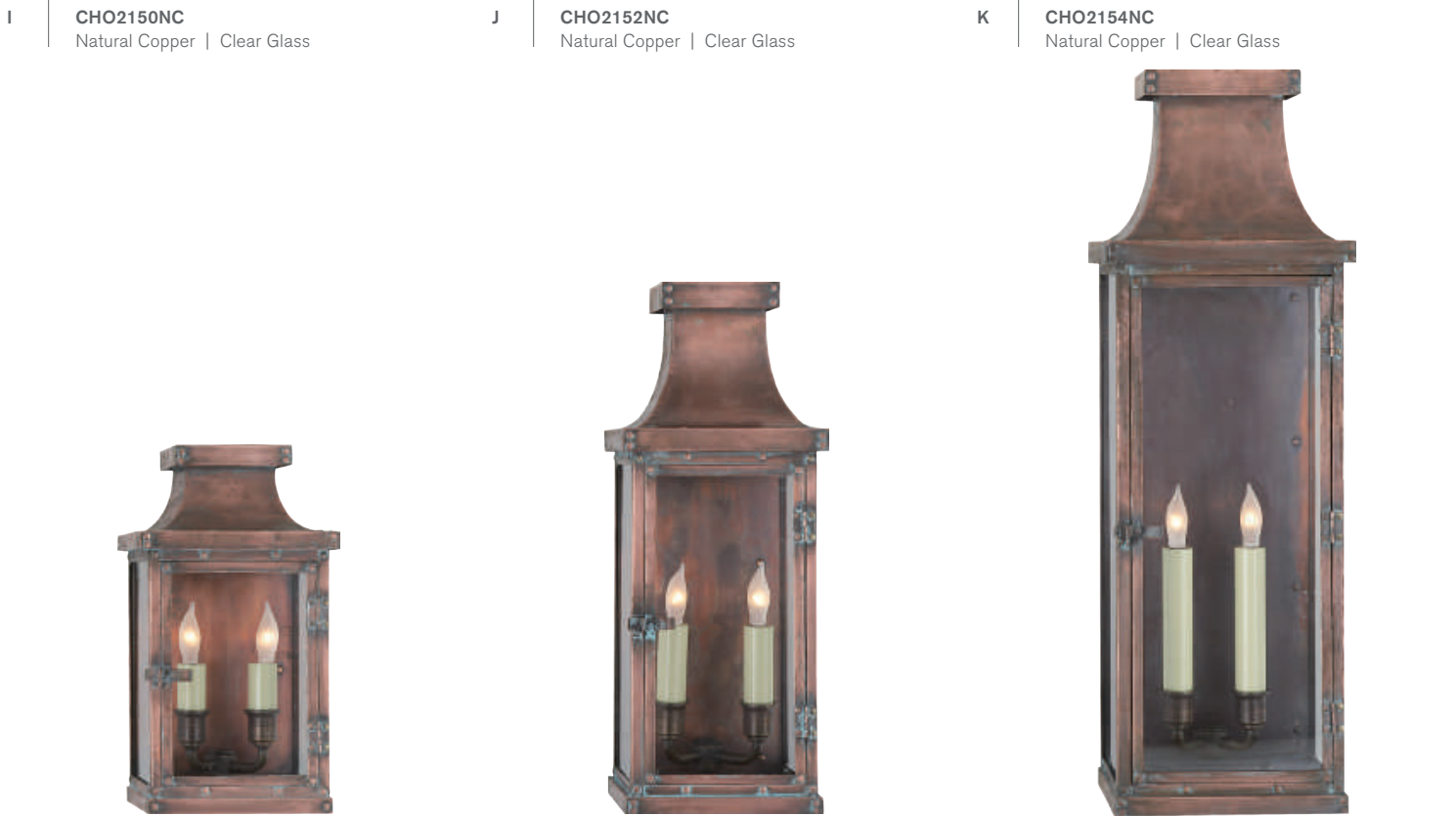
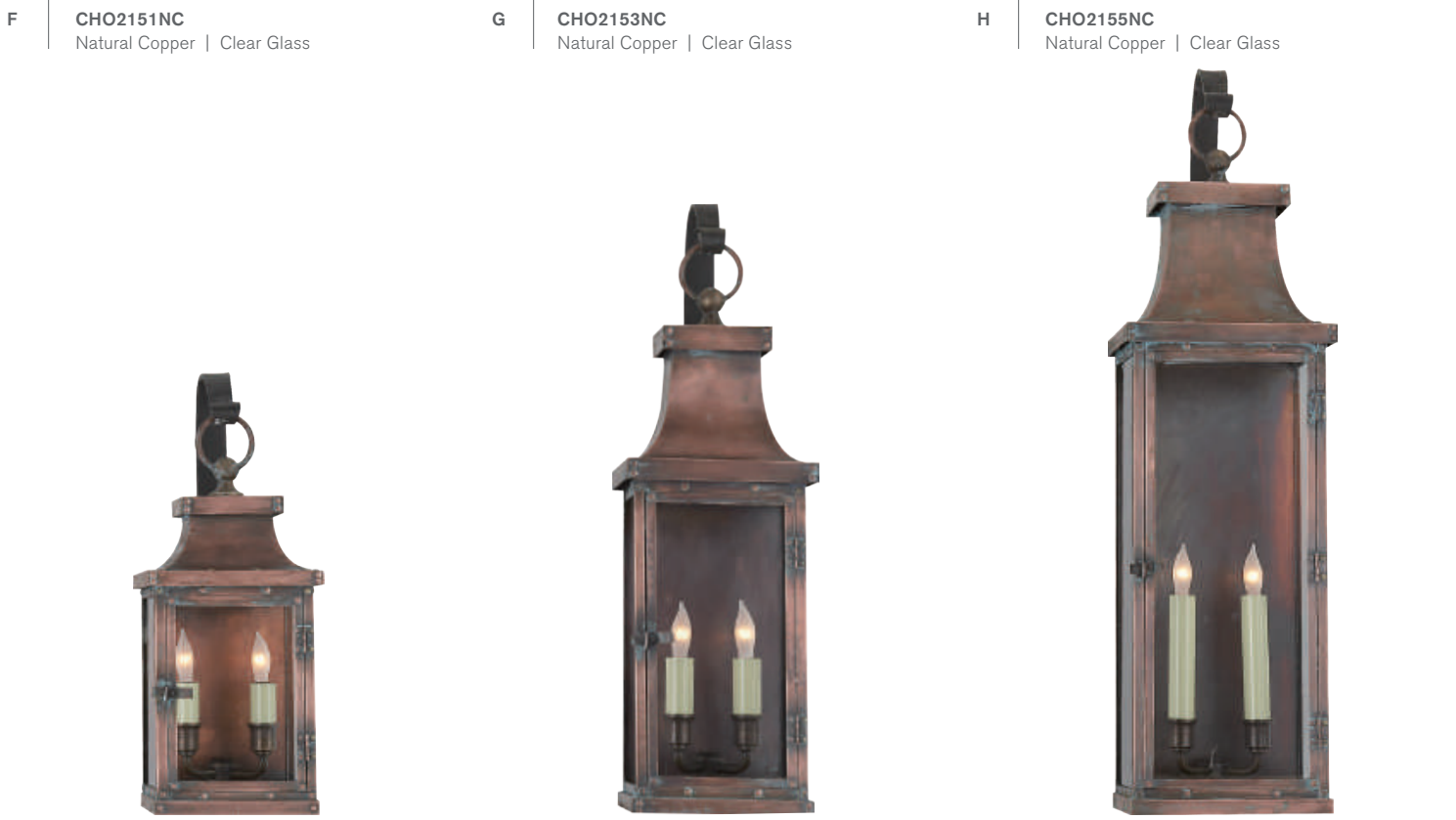

**C** **CHO2156NC**  
Natural Copper | Clear Glass

**D** **CHO2157NC**  
Natural Copper | Clear Glass

**C** **BEDFORD MEDIUM WIDE 3/4 WALL LANTERN**  
E. F. CHAPMAN

**CHO2156**  
H: 18" | W: 9.75" | Ext: 6"  
Backplate: 8.25" x 11"  
Socket: 2 - E12 Candelabra | Bulb: 2 - 60 C  
©EFC DESIGNS

**D** **BEDFORD LARGE WIDE 3/4 WALL LANTERN**  
E. F. CHAPMAN

**CHO2157**  
H: 24" | W: 9.75" | Ext: 6"  
Backplate: 8.25" x 14.75"  
Socket: 2 - E12 Candelabra | Bulb: 2 - 60 C  
©EFC DESIGNS



**E** **CHO7820NC-CG**  
Natural Copper | Clear Glass

**I** **BEDFORD SMALL 3/4 WALL LANTERN**  
E. F. CHAPMAN

**CHO2150**  
H: 12" | W: 6.75" | Ext: 6"  
Backplate: 5.25" x 5.5"  
Socket: 2 - E12 Candelabra | Bulb: 2 - 60 C  
©EFC DESIGNS

**J** **BEDFORD MEDIUM 3/4 WALL LANTERN**  
E. F. CHAPMAN

**CHO2152**  
H: 17.25" | W: 6.75" | Ext: 6"  
Backplate: 5.25" x 8.75"  
Socket: 2 - E12 Candelabra | Bulb: 2 - 60 C  
©EFC DESIGNS

**K** **BEDFORD LARGE 3/4 WALL LANTERN**  
E. F. CHAPMAN

**CHO2154**  
H: 24" | W: 8" | Ext: 6"  
Backplate: 6.5" x 14.75"  
Socket: 2 - E12 Candelabra | Bulb: 2 - 60 C  
©EFC DESIGNS

A

**SK2350BC**  
Blackened Copper | Clear Glass



**A HONORE SMALL BRACKET WALL LANTERN**  
SUZANNE KASLER

**SK2350**  
H: 18.25" | W: 9" | Ext: 8.25"  
Backplate: 4" x 12.75" Rec.  
Socket: E12 Candelabra | Bulb: 60 C

**B HONORE MEDIUM BRACKET WALL LANTERN**  
SUZANNE KASLER

**SK2351**  
H: 24" | W: 11.5" | Ext: 10.5"  
Backplate: 4" x 15" Rec.  
Socket: 3 - E12 Candelabra | Bulb: 3 - 60 C

**C HONORE MEDIUM FRAME HANGING LANTERN**  
SUZANNE KASLER

**SK5305**  
H: 25" | W: 15.25" | Canopy: 5" Round  
Socket: 3 - E12 Candelabra | Bulb: 3 - 60 C

B

**SK2351BC**  
Blackened Copper | Clear Glass



D

**HONORE SMALL 3/4 WALL LANTERN**  
SUZANNE KASLER

**SK2325**  
H: 13.75" | W: 9" | Ext: 6"  
Backplate: 7.75" X 9.25" Rec.  
Socket: E12 Candelabra | Bulb: 60 C

E

**HONORE MEDIUM 3/4 WALL LANTERN**  
SUZANNE KASLER

**SK2326**  
H: 17.75" | W: 11.5" | Ext: 7.5"  
Backplate: 10" x 11.75" Rec.  
Socket: 2 - E12 Candelabra | Bulb: 2 - 60 C

F

**HONORE LARGE 3/4 WALL LANTERN**  
SUZANNE KASLER

**SK2327**  
H: 24.5" | W: 16" | Ext: 11"  
Backplate: 14" x 16.75" Rec.  
Socket: 3 - E12 Candelabra | Bulb: 3 - 60 C

D

**SK2325BC**  
Blackened Copper | Clear Glass



E

**SK2326BC**  
Blackened Copper | Clear Glass



F

**SK2327BC**  
Blackened Copper | Clear Glass



C

**SK5305BC**  
Blackened Copper | Clear Glass



G

**HOLBORN MEDIUM POST LIGHT**  
E. F. CHAPMAN

**CHO7215**  
H: 25" | W: 15.5"  
Base: 3" Round Post Cap  
Socket: 4 - E12 Candelabra | Bulb: 4 - 60 C  
©EFC DESIGNS

H

**HOLBORN LARGE BRACKETED WALL LANTERN**  
E. F. CHAPMAN

**CHO2215**  
H: 33.5" | W: 18.25" | Ext: 20.75"  
Backplate: 4.25" x 5.25" Rec.  
Socket: 4 - E12 Candelabra | Bulb: 4 - 60 C  
©EFC DESIGNS

I

**HOLBORN SMALL BRACKETED WALL LANTERN**  
E. F. CHAPMAN

**CHO2216**  
H: 26" | W: 14" | Ext: 15.75"  
Backplate: 4.25" x 5.25" Rec.  
Socket: 4 - E12 Candelabra | Bulb: 4 - 60 C  
©EFC DESIGNS

**Additional Options for Holborn:**  
Old White | Clear Glass (OW-CG)  
**General Note for Holborn:**  
\* Finish Will Patina in Full Weather  
\* Extreme Conditions May Deteriorate Finish

G

**CHO7215AI-CG**  
Aged Iron | Clear Glass



H

**CHO2215AI-CG**  
Aged Iron | Clear Glass



I

**CHO2216AI-CG**  
Aged Iron | Clear Glass



A NW2708FR-CG  
French Rust



B NW2710FR-CG  
French Rust



C NW2709FR-CG  
French Rust | Clear Glass



A ORLEANS SMALL BRACKETED LANTERN  
NIERMANN WEEKS

NW2708  
H: 25.5" | W: 9.5" | Ext: 11.25"  
Backplate: 5" x 7" Rec.  
Socket: E12 Candelabra | Bulb: 40 C

B ORLEANS MEDIUM BRACKETED LANTERN  
NIERMANN WEEKS

NW2710  
H: 31.25" | W: 12.5" | Ext: 13"  
Backplate: 5" x 7" Rec.  
Socket: 3 - E12 Candelabra | Bulb: 3 - 40 C

C ORLEANS LARGE BRACKET WALL LANTERN  
NIERMANN WEEKS

NW2709  
H: 38.5" | W: 16" | Ext: 18"  
Backplate: 6" x 10.75" Rec.  
Socket: 4 - E12 Candelabra | Bulb: 4 - 60 C

D NW2711FR-CG  
French Rust



E NW2712FR-CG  
French Rust | Clear Glass



F NW2713FR-CG  
French Rust



D ORLEANS SMALL 3/4 SCONCE  
NIERMANN WEEKS

NW2711  
H: 19.25" | W: 9.5" | Ext: 6.25"  
Backplate: 8" x 9" Decorative  
Socket: E12 Candelabra | Bulb: 40 C

E ORLEANS MEDIUM 1/2 WALL LANTERN  
NIERMANN WEEKS

NW2712  
H: 23.25" | W: 12.5" | Ext: 8.5"  
Backplate: 6.75" x 7" Decorative  
Socket: 2 - E12 Candelabra | Bulb: 2 - 60 C

F ORLEANS LARGE 3/4 SCONCE  
NIERMANN WEEKS

NW2713  
H: 29.75" | W: 16" | Ext: 10.25"  
Backplate: 13" x 13.75" Decorative  
Socket: 3 - E12 Candelabra | Bulb: 3 - 40 C

G ORLEANS SMALL HANGING LANTERN  
NIERMANN WEEKS

NW5707  
H: 21.75" | W: 9.5" | Canopy: 6" Round  
Socket: E12 Candelabra | Bulb: 40 C

H ORLEANS MEDIUM HANGING LANTERN  
NIERMANN WEEKS

NW5708  
H: 26" | W: 12.5" | Canopy: 6" Round  
Socket: 3 - E12 Candelabra | Bulb: 3 - 40 C

I ORLEANS LARGE HANGING LANTERN  
NIERMANN WEEKS

NW5709  
H: 33.75" | W: 16" | Canopy: 6" Round  
Backplate: 6" x 10.75" Rec.  
Socket: 4 - E12 Candelabra | Bulb: 4 - 60 C

G NW5707FR-CG  
French Rust



H NW5708FR-CG  
French Rust



I NW5709FR-CG  
French Rust | Clear Glass



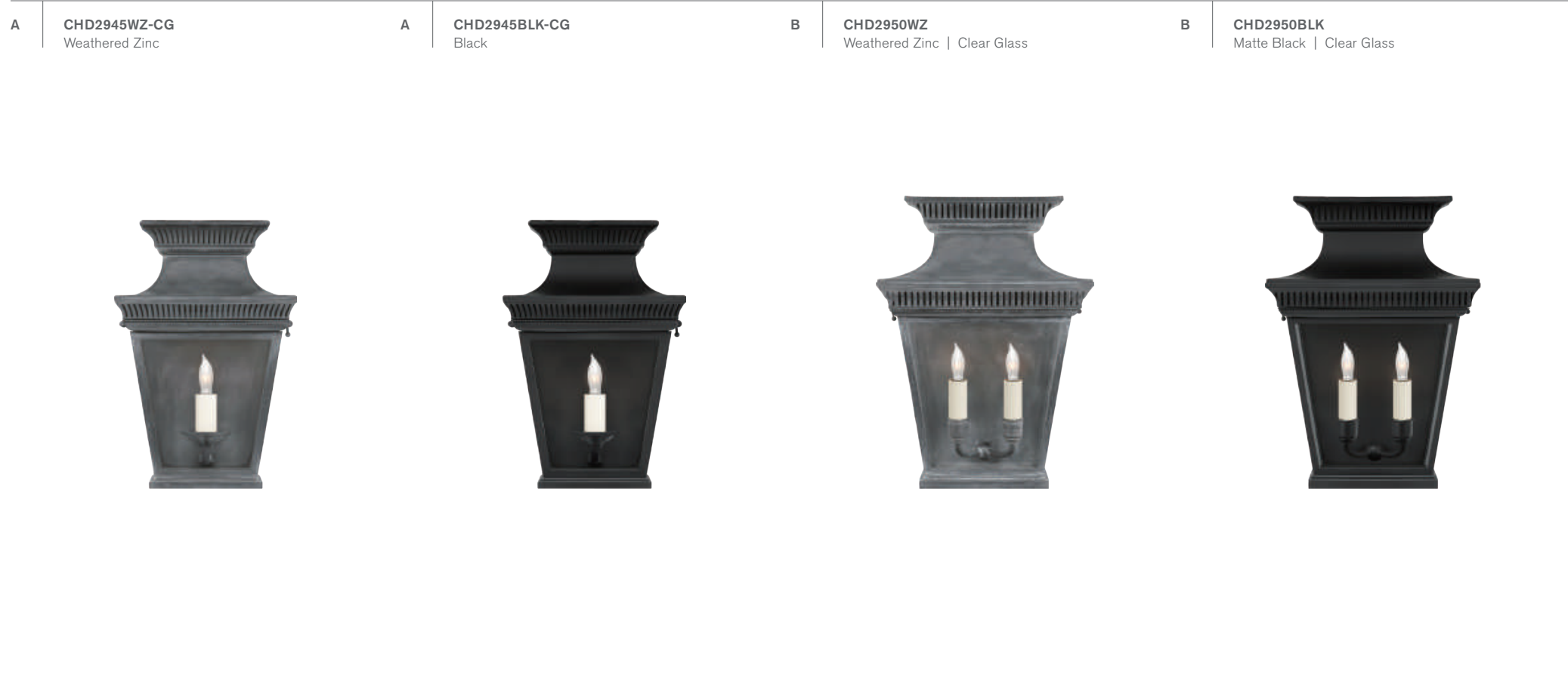

opposite page

**A ELSINORE SMALL 3/4 WALL SCONCE**  
E. F. CHAPMAN

**CHD2945**  
H: 12" | W: 8.5" | Ext: 5.75"  
Backplate: 4.25" x 6.75" Rec.  
Socket: E12 Candelabra | Bulb: 40 C  
**Additional Options:**  
Old White | Clear Glass (OW-CG)  
©EFC DESIGNS

**B ELSINORE 3/4 WALL LANTERN**  
E. F. CHAPMAN

**CHD2950**  
H: 15.75" | W: 11" | Ext: 7.75"  
Backplate: 5.5" x 9.5" Rec.  
Socket: 2 - E12 Candelabra | Bulb: 2 - 60 C  
**Additional Options:**  
Old White | Clear Glass (OW-CG)  
©EFC DESIGNS

**General Notes for Elsinore Lanterns:**  
\* Finish Will Patina in Full Weather  
\* Extreme Conditions May Deteriorate Finish

**C ELSINORE EXTRA LARGE 3/4 WALL SCONCE**  
E. F. CHAPMAN

**CHD2960**  
H: 28" | W: 19.5" | Ext: 13.25"  
Backplate: 10" x 16" Rec.  
Socket: 3 - E12 Candelabra | Bulb: 3 - 40 C  
**Additional Options:**  
Old White | Clear Glass (OW-CG)  
©EFC DESIGNS

**D ELSINORE 3/4 LARGE WALL LANTERN**  
E. F. CHAPMAN

**CHD2955**  
H: 24" | W: 16.75" | Ext: 10.75"  
Backplate: 8.5" x 13.75" Rec.  
Socket: 3 - E12 Candelabra | Bulb: 3 - 60 C  
**Additional Options:**  
Old White | Clear Glass (OW-CG)  
©EFC DESIGNS

**General Notes for Elsinore Lanterns:**  
\* Finish Will Patina in Full Weather  
\* Extreme Conditions May Deteriorate Finish

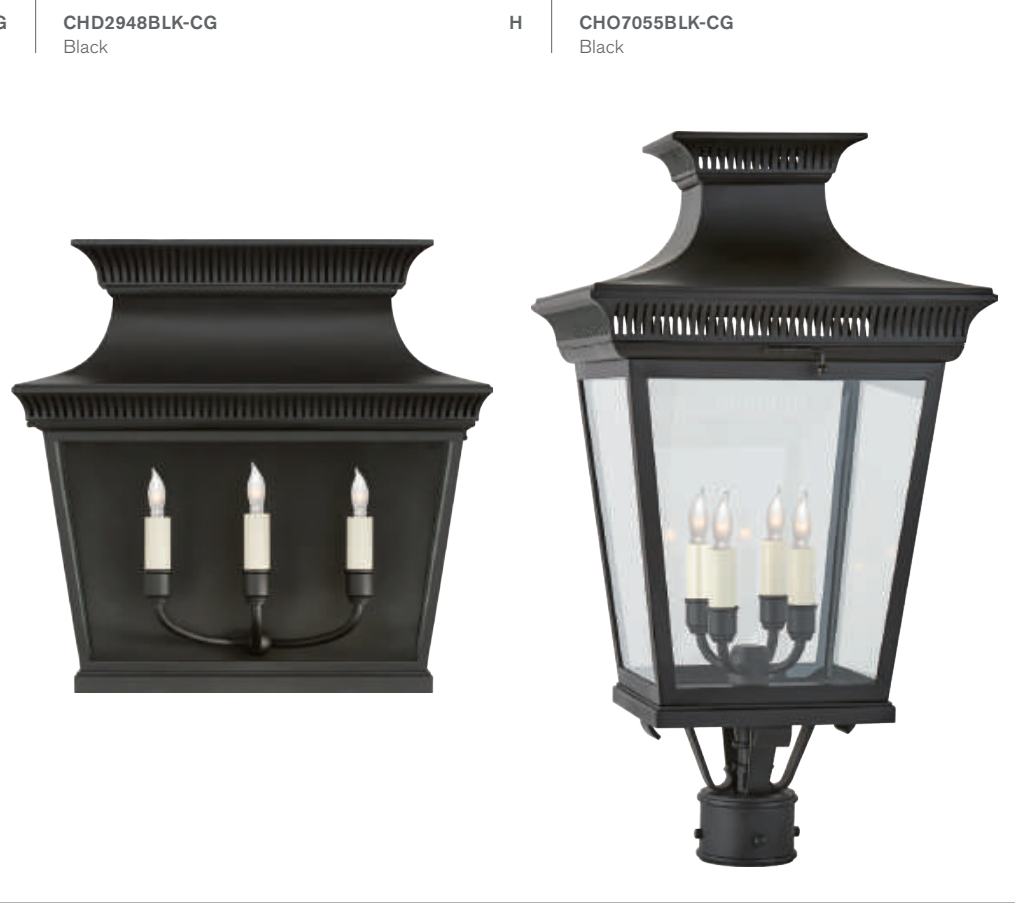

**E ELSINORE BRACKET WALL LANTERN**  
E. F. CHAPMAN

**CHD2952**  
H: 20.5" | W: 11" | Ext: 11.75"  
Backplate: 4.5" x 5" Rec.  
Socket: 4 - E12 Candelabra | Bulb: 4 - 60 C  
**Additional Options:**  
Black (BLK-CG)  
©EFC DESIGNS

**F ELSINORE LARGE BRACKET WALL SCONCE**  
E. F. CHAPMAN

**CHD2953**  
H: 31.25" | W: 16.75" | Ext: 17.75"  
Backplate: 4.5" x 6" Rec.  
Socket: 4 - E12 Candelabra | Bulb: 4 - 40 C  
**Additional Options:**  
Black (BLK-CG)  
©EFC DESIGNS

**General Notes for Elsinore Lanterns:**  
\* Finish Will Patina in Full Weather  
\* Extreme Conditions May Deteriorate Finish

**G ELSINORE EXTRA WIDE 3/4 SCONCE**  
E. F. CHAPMAN

**CHD2948**  
H: 17" | W: 18" | Ext: 7"  
Backplate: 9" x 12.75" Rec.  
Socket: 3 - E12 Candelabra | Bulb: 3 - 40 C  
**Additional Options:**  
Weathered Zinc (WZ-CG)  
Old White | Clear Glass (OW-CG)  
©EFC DESIGNS

**H ELSINORE MEDIUM POST LANTERN**  
E. F. CHAPMAN

**CHO7055**  
H: 27" | W: 14.5" | Ext: 14.5"  
Socket: 4 - E12 Candelabra | Bulb: 4 - 40 C  
Base: 3" Round Post Cap  
**Additional Options:**  
Weathered Zinc (WZ-CG)  
©EFC DESIGNS

**General Notes for Elsinore Lanterns:**  
\* Finish Will Patina in Full Weather  
\* Extreme Conditions May Deteriorate Finish



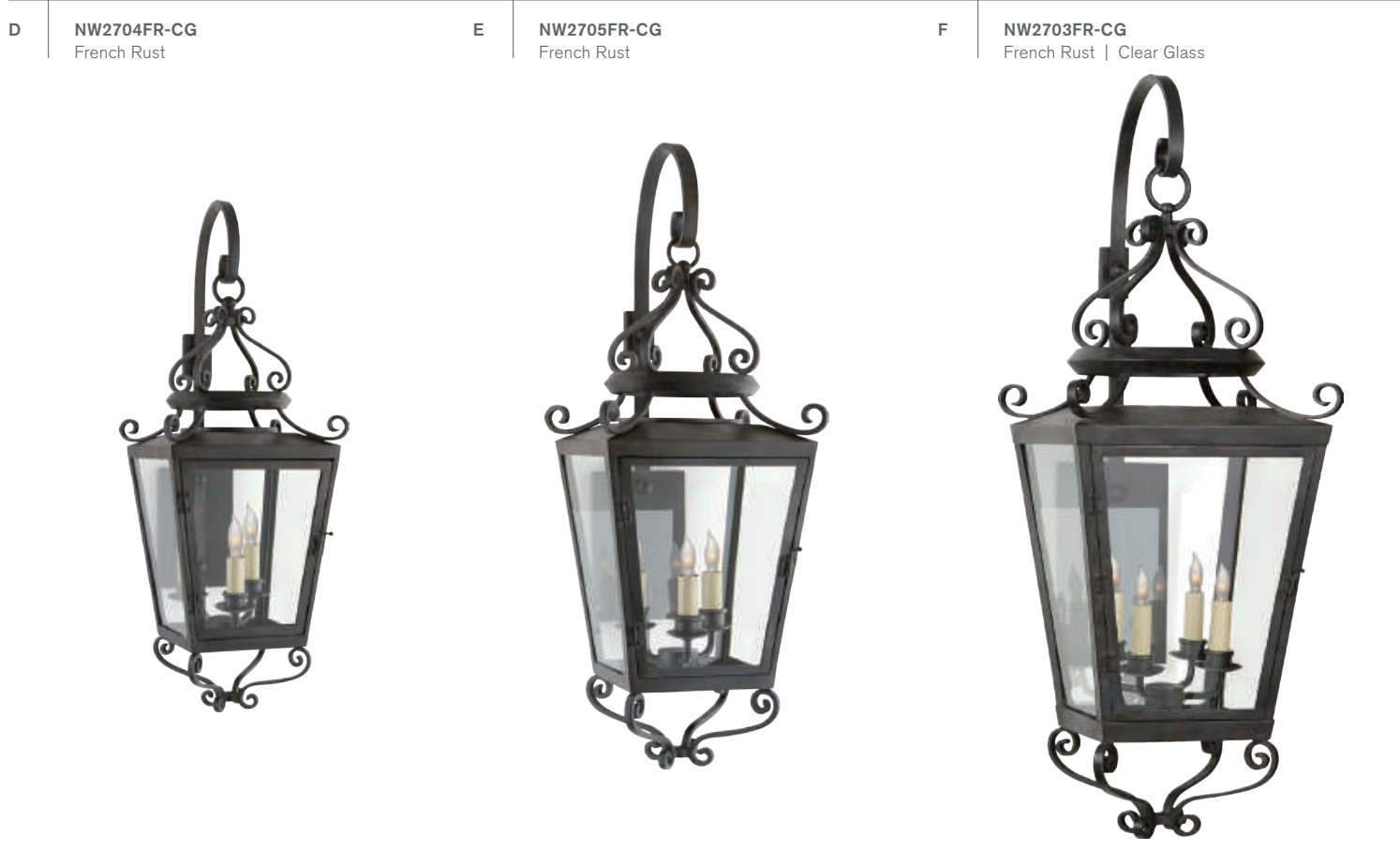
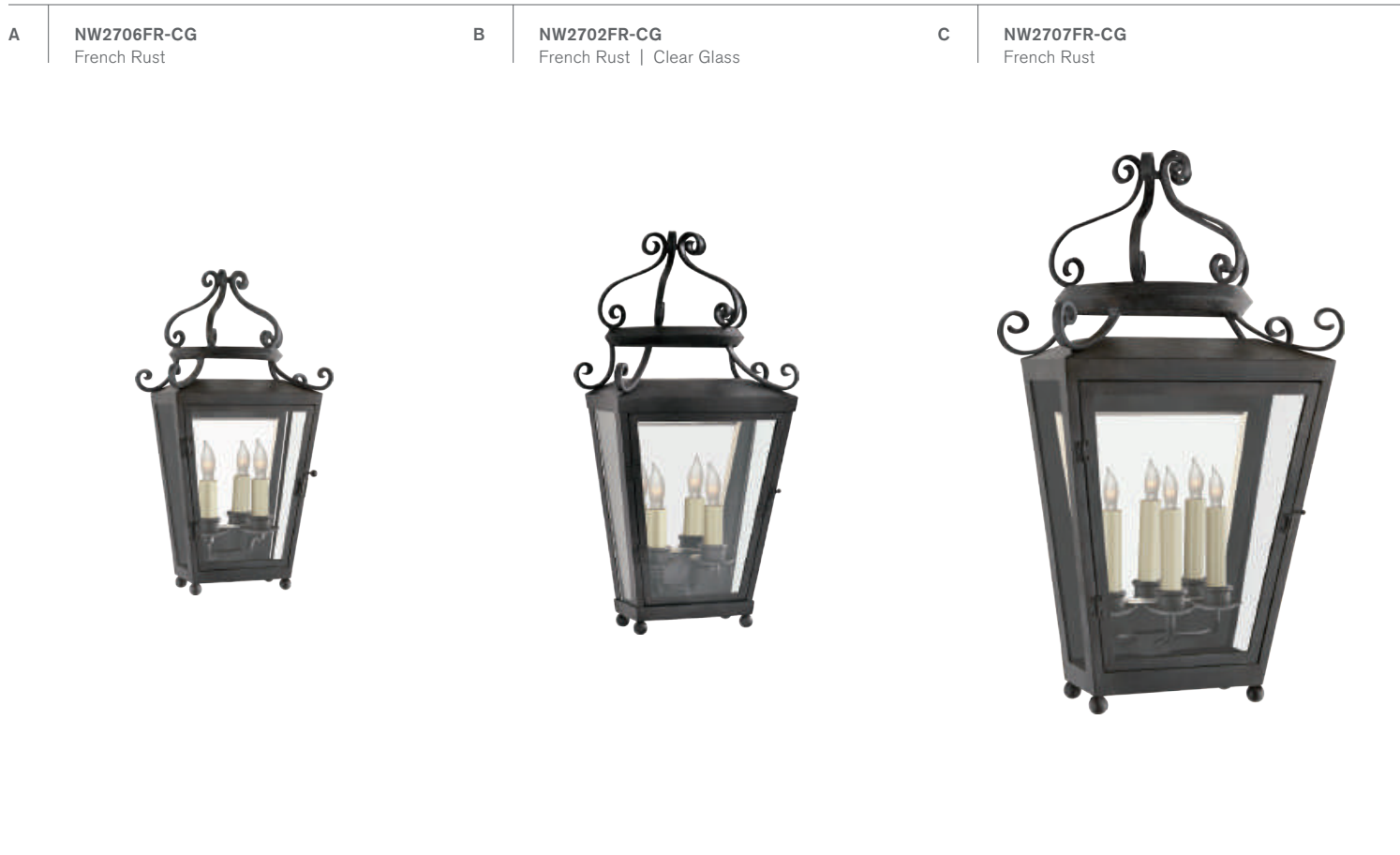

**A** LAFAYETTE SMALL 1/2 SCONCE  
NIERMANN WEEKS

**NW2706**  
H: 19" | W: 9.25" | Ext: 5"  
Backplate: 7.5" x 8.25" Decorative  
Socket: 2 - E12 Candelabra | Bulb: 2 - 40 C

**B** LAFAYETTE MEDIUM 1/2 WALL LANTERN  
NIERMANN WEEKS

**NW2702**  
H: 23.5" | W: 11.5" | Ext: 5.5"  
Backplate: 9.75" x 10.25" Decorative  
Socket: 2 - E12 Candelabra | Bulb: 2 - 60 C

**C** LAFAYETTE LARGE 1/2 SCONCE  
NIERMANN WEEKS

**NW2707**  
H: 31" | W: 15.25" | Ext: 6.75"  
Backplate: 12.75" x 14" Decorative  
Socket: 3 - E12 Candelabra | Bulb: 3 - 40 C

**D** LAFAYETTE SMALL BRACKETED LANTERN  
NIERMANN WEEKS

**NW2704**  
H: 33.75" | W: 14.25" | Ext: 11.25"  
Backplate: 4.25" x 6.5" Rec.  
Socket: 3 - E12 Candelabra | Bulb: 3 - 40 C

**E** LAFAYETTE MEDIUM BRACKETED SCONCE  
NIERMANN WEEKS

**NW2705**  
H: 30.75" | W: 11.25" | Ext: 13.75"  
Backplate: 5" x 8" Rec.  
Socket: 3 - E12 Candelabra | Bulb: 3 - 40 C

**F** LAFAYETTE LARGE BRACKET WALL LANTERN  
NIERMANN WEEKS

**NW2703**  
H: 38.5" | W: 14.25" | Ext: 17"  
Backplate: 6" x 10.75" Rec.  
Socket: 4 - E12 Candelabra | Bulb: 4 - 60 C

**G** LAFAYETTE SMALL HANGING LANTERN  
NIERMANN WEEKS

**NW5702**  
H: 21.25" | W: 8.75" | Canopy: 6" Round  
Socket: E12 Candelabra | Bulb: 40 C

**H** LAFAYETTE LARGE HANGING LANTERN  
NIERMANN WEEKS

**NW5704**  
H: 33.75" | W: 14.25" | Canopy: 6" Round  
Socket: 4 - E12 Candelabra | Bulb: 4 - 60 C

**I** LAFAYETTE MEDIUM HANGING LANTERN  
NIERMANN WEEKS

**NW5703**  
H: 26" | W: 11.25" | Canopy: 6" Round  
Socket: 3 - E12 Candelabra | Bulb: 3 - 40 C



**G** NW5702FR-CG  
French Rust

**H** NW5704FR-CG  
French Rust | Clear Glass

**I** NW5703FR-CG  
French Rust



**A** | **CHO2004WZ-FG**  
Weathered Zinc | Frosted Glass

**A** | **CHO2004AI-FG**  
Aged Iron | Frosted Glass

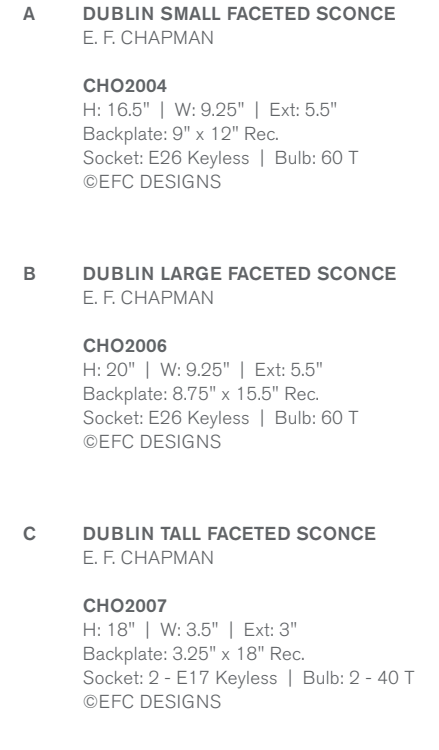

**C** | **CHO2007WZ-FG**  
Weathered Zinc | Frosted Glass

**DUBLIN SMALL FACETED SCONCE**  
E. F. CHAPMAN

**CHO2004**  
H: 16.5" | W: 9.25" | Ext: 5.5"  
Backplate: 9" x 12" Rec.  
Socket: E26 Keyless | Bulb: 60 T  
©EFC DESIGNS

**DUBLIN LARGE FACETED SCONCE**  
E. F. CHAPMAN

**CHO2006**  
H: 20" | W: 9.25" | Ext: 5.5"  
Backplate: 8.75" x 15.5" Rec.  
Socket: E26 Keyless | Bulb: 60 T  
©EFC DESIGNS

**DUBLIN TALL FACETED SCONCE**  
E. F. CHAPMAN

**CHO2007**  
H: 18" | W: 3.5" | Ext: 3"  
Backplate: 3.25" x 18" Rec.  
Socket: 2 - E17 Keyless | Bulb: 2 - 40 T  
©EFC DESIGNS



**B** | **CHO2006WZ-FG**  
Weathered Zinc | Frosted Glass

**B** | **CHO2006AI-FG**  
Aged Iron | Frosted Glass

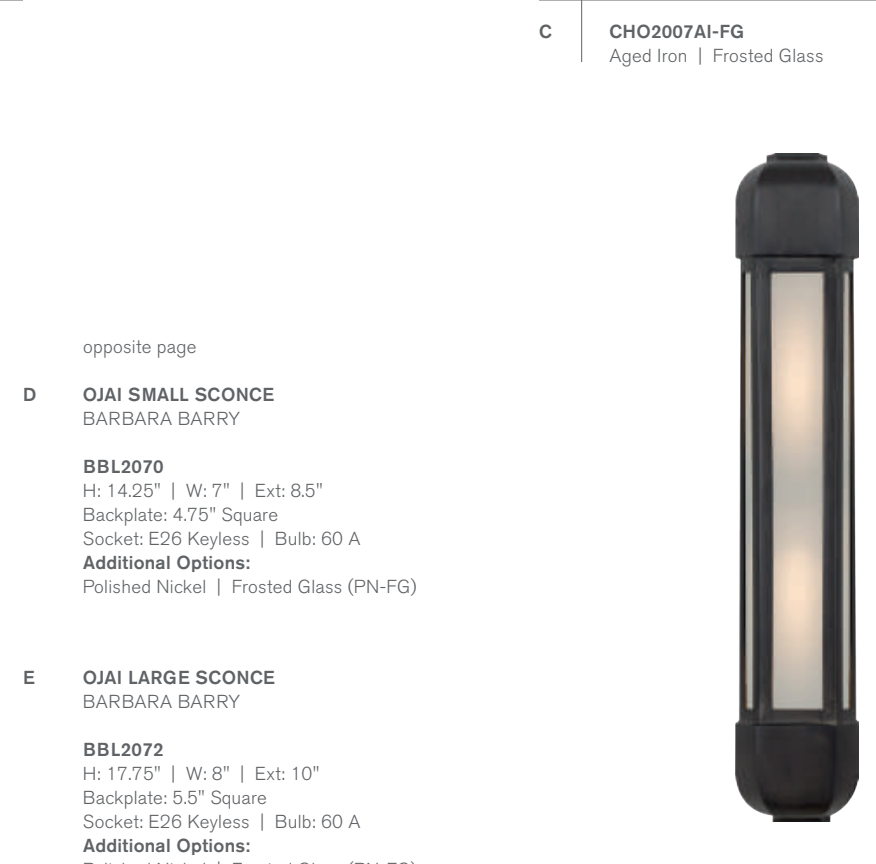

**C** | **CHO2007AI-FG**  
Aged Iron | Frosted Glass

opposite page

**OJAI SMALL SCONCE**  
BARBARA BARRY

**BBL2070**  
H: 14.25" | W: 7" | Ext: 8.5"  
Backplate: 4.75" Square  
Socket: E26 Keyless | Bulb: 60 A  
**Additional Options:**  
Polished Nickel | Frosted Glass (PN-FG)

**OJAI LARGE SCONCE**  
BARBARA BARRY

**BBL2072**  
H: 17.75" | W: 8" | Ext: 10"  
Backplate: 5.5" Square  
Socket: E26 Keyless | Bulb: 60 A  
**Additional Options:**  
Polished Nickel | Frosted Glass (PN-FG)



**E** | **BBL2072BZ-FG**  
Bronze | Frosted Glass



**D** | **BBL2070BZ-FG**  
Bronze | Frosted Glass



**E** | **BBL2072BZ-FG**  
Bronze | Frosted Glass



**A** | **SLO2003CH-CG**  
Chrome | Clear Glass



**A** | **SLO2003WZ-SG**  
Weathered Zinc | Seeded Glass



**A** | **SLO2003BZ-SG**  
Bronze | Seeded Glass

opposite page

**A** | **MARINE MEDIUM EXTENDED SCONCE**  
E. F. CHAPMAN

**SLO2003**  
H: 16.25" | W: 12" | Backplate: 6" Round  
Socket: E26 Keyless | Bulb: 60 A  
\* Bulb Sold Separately (B-30M)  
©EFC DESIGNS

**B** | **MARINE CAGED HOODED SCONCE**  
E. F. CHAPMAN

**SLO2001**  
H: 10.5" | W: 8.5" | Ext: 10"  
Backplate: 4.5" x 6.5" Rec.  
Socket: E26 Keyless | Bulb: 60 A  
\* Bulb Sold Separately (B-30M)  
©EFC DESIGNS

**C** | **MARINE MEDIUM FLUSH MOUNT**  
E. F. CHAPMAN

**SLO4002**  
H: 15" | W: 12" | Canopy: 6" Round  
Socket: E26 Keyless | Bulb: 60 A  
\* Bulb Sold Separately (B-30M)  
©EFC DESIGNS

**D** | **MARINE TALL FLUSH MOUNT**  
E. F. CHAPMAN

**SLO4000**  
H: 10.5" | W: 6" | Canopy: 6" Round  
Socket: E26 Keyless | Bulb: 60 A  
\* Bulb Sold Separately (B-30M)  
©EFC DESIGNS

**B** | **SLO2001BZ-SG**  
Bronze | Seeded Glass



**B** | **SLO2001WZ-SG**  
Weathered Zinc | Seeded Glass



**B** | **SLO2001CH-CG**  
Chrome | Clear Glass



**C** | **SLO4002BZ-SG**  
Bronze | Seeded Glass



**C** | **SLO4002WZ-SG**  
Weathered Zinc | Seeded Glass



**C** | **SLO4002CH-CG**  
Chrome | Clear Glass



**D** | **SLO4000BZ-SG**  
Bronze | Seeded Glass



**D** | **SLO4000WZ-SG**  
Weathered Zinc | Seeded Glass



**D** | **SLO4000CH-CG**  
Chrome | Clear Glass





FINISHES



## **SIGNATURE FINISHES**

Our “living” finishes make the difference for lighting choices that are unique in personality and design appeal. We use authentic natural materials to give our products their custom character: brass, bronze, nickel, silver and chrome in antique and polished lusters; classic enamels, ceramic, porcelain and gilding; forged irons and honed woods; hand blown glass; rock crystal and alabaster; elegant parchment papers, silks and linens.

Our selection of more than eighty finishes is a central part of our promise to serve all aesthetic preferences and design applications in our lighting. These abundant options can help you adapt your favorite lighting profiles to the right mood for your project. From the superior quality of our Hand-Rubbed Antique Brass and Polished Nickel to the perfect elegance of Gilded Iron and Antique Silver Leaf, and many more casual and painted finishes in between, we have the look that will help you create your own lighting décor.



Aged Iron Alabaster Antique Brass Antique Mirror Antique Nickel Antique Silver Antique White Antique Zinc



Aqua Crackle Belgian White Berry Red Black Black Marble Blackened Copper Blackened Rust Blue Celadon



Blue Lagoon Blush Bone Craquelure Bronze Brown Marble Burnished Silver Leaf Burnt Gold Celadon Crackle



Chrome Cinnabar Coconut Crystal Crystal Bronze Dark Honey Denim Drizzled Cobalt



French Rust French Waxed Wood Garden Stone Gild Gilded Iron Gilded Plaster Gloss Black Green Glass



Green Marble Green Porcelain Grey Glass Gun Metal Ivory Light Honey Lime Limestone



Maraschino Marbleized Sienna Matte Black Matte Bronze Matte Sky Blue Matte White Mercury Glass Midnight Blue



Mixed Blue Brown Natural Brass Natural Copper Natural Iron Natural Quartz Stone Natural Rust Old White Oslo Blue



Pebbled Aquamarine Pewter Plaster White Polar Blue Crackle Polished Nickel Polished Silver Sheffield Nickel Sheffield Silver



Shellish Gray Shellish Kiwi Soft Brass Soft Silver Tea Stain Crackle Tudor Brown Stain Venetian Gold Venetian Silver

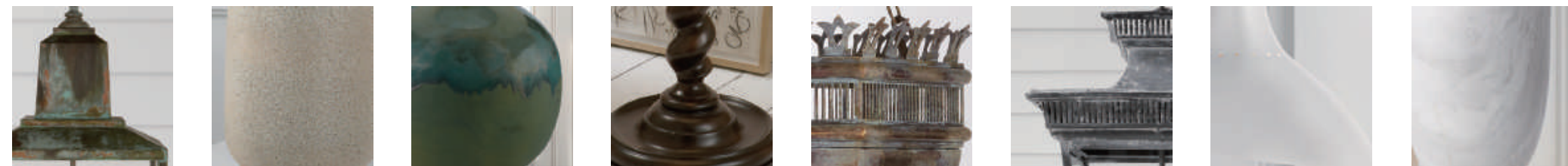

Verdigris Volcanic Ivory Volcanic Verdi Walnut Weathered Verdigris Weathered Zinc White White Marble

LAMP AND FIXTURE FINISH CODES

Table with 3 columns: Code, Description, Code, Description. Includes finishes like AB (Antique-Burnished Brass), ALB (Alabaster), and various combinations like AB/CA, ALB/BM, etc.

Table with 2 columns: Code, Description. Includes finishes like HAB/CG (Hand-Rubbed Antique Brass with Crystal), I (Ivory), and various combinations like I/IC, I/ICB, etc.

Table with 2 columns: Code, Description. Includes finishes like PS (Polished Silver), PW (Plaster White), and various combinations like PW/G, PWI, PWT, etc.

SHADE, TRIM, AND GLASS FINISH CODES

Table with 2 columns: Code, Description. Includes finishes like AB (Antique-Burnished Brass), AI (Aged Iron), ALB (Alabaster), AN (Antique Nickel), and various combinations like AN/PN, AN/PG, etc.

Table with 2 columns: Code, Description. Includes finishes like L/PN (Linen with Polished Nickel Trim), L/SB (Cream Linen with Soft Brass Trim), LC (Linen Collar), and various combinations like LC/LCC, LC/LMG, etc.

CHANDELIER AND SCONCE SHADES

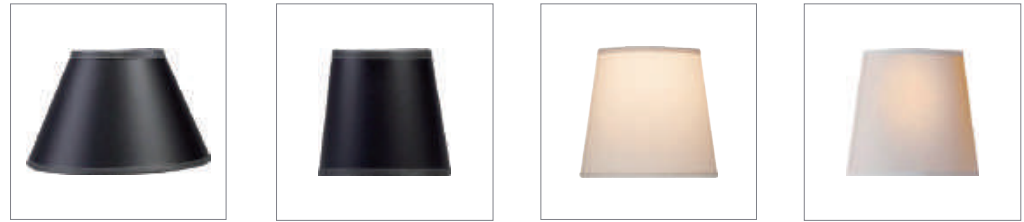

CHS101B Black Paper 3" x 6" x 5"
CHS104B Black Paper 3" x 4.25" x 4"
CHS104L Linen 3" x 4.25" x 4"
CHS104NP Natural Paper 3" x 4.25" x 4"

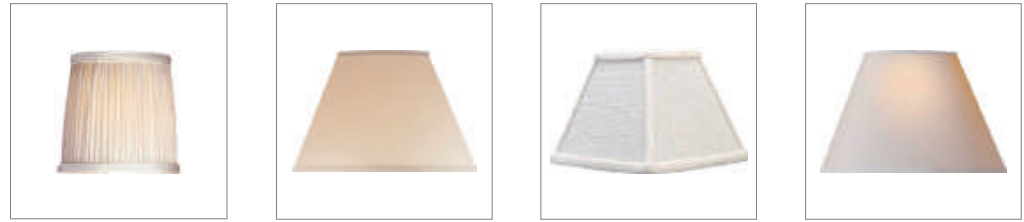

CHS104S Silk 3" x 4.25" x 4"
CHS106L Linen 3" x 6" x 4.25"
CHS106LSQ Linen 3" x 6" x 4"
CHS106NP Natural Paper 3" x 6" x 4.25"



CHS109S Silk 2.5" x 5" x 4.5"
CHS111S Silk 4" x 9" x 5.5"
CHS112NP Natural Paper 4" x 9" x 6"
CHS113S Silk 3.5" x 5" x 5"



CHS114NP Natural Paper 4" x 6" x 5"

CARE INSTRUCTIONS

All products should be cleaned with a soft, dry cloth or duster. Our products should never be sprayed with a cleaning solution or polish. When it is necessary to use a cleaning agent, please apply only a mild detergent to a soft, damp cloth for gentle cleansing.

CUSTOMIZATION

Many of our products can be modified in our custom department. Changing height, finish, or switch type on an item can be done upon request.

VARIATION

Minor variations may occur in product dimensions and finishes due to the handmade nature of our products. We recommend that designs being purchased in pairs or sets for a specific job be ordered together to ensure they match.

BASE CODE	PAGE	BASE CODE	PAGE	BASE CODE	PAGE	BASE CODE	PAGE	BASE CODE	PAGE	BASE CODE	PAGE	BASE CODE	PAGE	BASE CODE	PAGE	BASE CODE	PAGE	BASE CODE	PAGE	BASE CODE	PAGE	BASE CODE	PAGE
81134	231	ARN1027	164	ARN2401	873	ARN4124	611	ARN5307	420	BBL5009	434	CHA8950	66	CHC2111	562	CHC3439	529	CHD1155	662	CHD2945	949	CHO2215	946
82034	821, 822	ARN1034	192	ARN2450	792	ARN4125	611	ARN5308	288	BBL5012	433	CHA8951	66	CHC2112	559	CHC3440	529, 530	CHD1156	662	CHD2948	950	CHO2216	946
91025	231, 232	ARN1042	217	ARN2452	792	ARN4126	611	ARN5310	287, 288	BBL5013	433	CHA8960	71	CHC2117	563, 564	CHC3444	533	CHD1158	709	CHD2950	949	CHO2788	933
92025	822	ARN1070	149	ARN2611	875	ARN4170	612	ARN5312	391	BBL5014	433	CHA8969	57, 101	CHC2128	562	CHC3453	529	CHD1183	684	CHD2952	950	CHO2789	933
92000D	812	ARN1080	151	ARN2650	803	ARN4171	612	ARN5330	381	BBL5015	440	CHA8970	57, 101, 102	CHC2135	560	CHC3568	537	CHD1184	683, 684	CHD2953	950	CHO2790	933
AH2000	761	ARN1101	193	ARN2910	784	ARN4172	612	ARN5350	445, 446	BBL5016	439	CHA8974	57	CHC2138	269	CHC4033	928	CHD1186	686	CHD2955	949	CHO2791	934
AH2001	761	ARN1301	147, 148	ARN2912	830	ARN4172	612	ARN5350	445, 446	BBL5023	426	CHA8983	61, 62	CHC2149	382	CHC4035	928	CHD1190	720	CHD2957	668	CHO2792	931
AH2010	762	ARN1420	187	ARN2920	784	ARN4307	587	ARN5352	445, 446	BBL5024	441, 442	CHA8994	98	CHC2156	397	CHC4036	928	CHD1191	719, 720	CHD2960	949	CHO5003	935
AH2012	813, 814	ARN1501	207	ARN3000	55	ARN4321	638	ARN5401	355	BBL5025	441	CHA9107	228	CHC2160	542	CHC4125	615	CHD1404	709	CHD2970	741	CHO5031	938
AH2023	862	ARN1712	206	ARN3002	86	ARN4401	640	ARN5402	356	BBL5030	427	CHA9121	197	CHC2161	539	CHC4126	615	CHD1407	709	CHD4175	689	CHO5032	938
AH2040	681	ARN2000	690, 915	ARN3003	140	ARN5001	379	ARN5426	380	BBL5031	438	CHA9124	198	CHC2164	511	CHC4128	615	CHD1495	710	CHD5101	815	CHO5033	938
AH2050	721	ARN3001	692	ARN3004	73	ARN5002	555, 556	ARN5450	356	BBL5032	437	CHA9125	198	CHC2165	509	CHC4129	616	CHD1496	710	CHD5102	816	CHO5084	932
AH2200	911, 912	ARN2002	801, 802	ARN3005	50	ARN5003	556	ARN5501	364	BBL5033	437	CHA9161	233	CHC2166	398	CHC4132	631	CHD1549	657	CHD5106	811	CHO5085	932
AH2201	913	ARN2003	802	ARN3006	127	ARN5006	363	ARN5503	364	BBL5080	340	CHA9461	171	CHC2167	541	CHC4206	610	CHD1550	867	CHD5117	841	CHO7031	938
AH2202	912	ARN2006	831	ARN3010	128	ARN5007	363	BBL1002	149, 150	BBL5081	339, 340	CHA9707	156	CHC2168	397	CHC4207	610	CHD1551	870	CHD5137	841	CHO7032	938
AH2203	913	ARN2007	653	ARN3022	85	ARN5008	362	BBL1018	199	BBL5088	417	CHC1140	271, 272	CHC2175	511	CHC4215	618	CHD1552	867, 868	CHD5147	841	CHO7033	938
AH2305	762	ARN2008	771	ARN3024	52	ARN5009	361	BBL1023	183	BBL5089	418	CHC1141	271	CHC2176	510	CHC4270	642	CHD1553	869, 870	CHD5148	841	CHO7055	950
AH2700	844	ARN2009	771	ARN3026	67	ARN5010	362	BBL1030	179	BBL5090	417, 418	CHC1144	274	CHC2177	510	CHC4391	614	CHD1555	661	CHO2004	953	CHO7110	936
AH2701	843, 844	ARN2010	671	ARN3030	64	ARN5011	379	BBL1036	178	BBL5102	518	CHC1154	273, 274	CHC2178	507	CHC4392	613, 614	CHD1563	874	CHO2006	953	CHO7111	936
AH2702	844	ARN2013	916	ARN3036	71	ARN5018	348	BBL1070	188	BBL5110	440	CHC1155	274	CHC2179	507, 508	CHC4402	581, 582	CHD1601	953	CHO2007	953	CHO7113	933
AH2703	844	ARN2018	745, 746, 887, 888	ARN3042	135	ARN5032	455	BBL2010	807	BBL5115	442	CHC1156	274	CHC2180	540	CHC4509	607	CHD1602	681, 682	CHO2017	930	CHO7215	946
AH3040	91	ARN2020	780	ARN3052	88	ARN5033	435	BBL2017	733, 734	BBL5122	435	CHC1180	272	CHC2181	540	CHC4600	622	CHD1610	718	CHO2018	929, 930	CHO7820	943
AH3050	66	ARN2022	701	ARN3062	7	ARN5036	347, 348	BBL2027	805	BBL5123	435	CHC1403	328	CHC2182	540	CHC5050	535	CHD1612	717, 718	CHO2019	930	CHO7821	942
AH3063	29	ARN2024	829	ARN3080	88	ARN5045	447	BBL2028	806	CHA8150	137	CHC1407	259	CHC2183	401	CHC5051	536	CHD1624	693	CHO2031	937	CL1002	177
AH3082	29	ARN2026	652	ARN3100	57, 90	ARN5052	350	BBL2029	806	CHA8162	122	CHC1408	260	CHC2185	512	CHC5052	536	CHD1625	694	CHO2032	937	CL2016	774
AH3100	78	ARN2027	652	ARN3144	86	ARN5100	283, 284	BBL2030	733	CHA8172	122	CHC1413	318	CHC2186	533	CHC5055	520	CHD1627	694	CHO2033	937	CL2181	773
AH3127	29, 30	ARN2036	775	ARN3301	85	ARN5101	284	BBL2035	739, 740	CHA8174	78	CHC1415	318	CHC2187	512	CHC5095	481	CHD2050	880	CHO2034	937	CS2102	695
AH3500	142	ARN2037	775	ARN3320	92	ARN5102	249, 250	BBL2036	743	CHA8188	119	CHC1420	270	CHC2190	539	CHC5101	489	CHD2102	798	CHO2035	937	CS2605	791
AH4004	593, 594	ARN2039	783, 784	ARN3600	91	ARN5104	250	BBL2039	740	CHA8315	120	CHC1426	259	CHC2199	508	CHC5102	410	CHD2150	820	CHO2036	937	CS2609	791
AH4005	593, 594	ARN2040	652	ARN3601	91, 92	ARN5105	239, 240	BBL2070	954	CHA8359	78	CHC1447	317	CHC2201	519, 520	CHC5132	490	CHD2153	891	CHO2040	934	CS3602	37
AH4014	585, 586	ARN2042	833	ARN3606	6	ARN5108	264	BBL2072	954	CHA8461	120	CHC1448	317	CHC2202	520	CHC5133	485	CHD2154	817, 818	CHO2041	934	CS3603	37
AH4015	586	ARN2043	784	ARN3608	5, 6	ARN5110	263	BBL2080	696	CHA8463	82	CHC1462	318	CHC2209	641	CHC5136	485, 487	CHD2165	767, 768	CHO2042	934	CS3606	38
AH4016	583, 584	ARN2045	774	ARN3609	5	ARN5111	381	BBL2082	749	CHA8530	93	CHC1474	313	CHC2215	536	CHC5157	375, 376	CHD2262	669, 670	CHO2043	932	CS3607	38
AH4017	583	ARN2051	698	ARN3610	9, 10	ARN5112	332	BBL2084	749	CHA8539	108	CHC1480	429, 430	CHC2216	536	CHC5158	375	CHD2266	742	CHO2044	932	CS3611	35, 36
AH4018	584	ARN2059	830	ARN3611	9	ARN5116	278	BBL2090	871, 872	CHA8608	25, 26	CHC1481	409	CHC2217	524	CHC5163	375	CHD2270	797, 798	CHO2045	934	CS3612	36
AH4021	591	ARN2065	776	ARN3614	11	ARN5120	240	BBL2092	790	CHA8613	26	CHC1482	409	CHC2224	542	CHC5165	375, 376	CHD2300	707, 708	CHO2060	941	CS3622	33, 34
AH4025	590	ARN2066	776	ARN3615	8	ARN5121	240	BBL2110	772	CHA8615	26	CHC1483	430	CHC2269	566	CHC5178	321	CHD2315	704	CHO2061	941	CS3626	34
AH4029	619	ARN2071	832	ARN3620	7	ARN5122	248	BBL2120	789	CHA8627	25, 121	CHC1494	311	CHC2270	565, 566	CHC5179	322	CHD2460	723, 724	CHO2062	943	CS3627	34
AH4030	619	ARN2072	832	ARN3621	8	ARN5123	244	BBL2130	744	CHA8642	25	CHC1508	259	CHC2271	566	CHC5199	321	CHD2461	724	CHO2063	941	CS3631	38
AH4200	597	ARN2080	702	ARN3622	7	ARN5124	243	BBL2132	744	CHA8646	79	CHC1520	270	CHC2298	566	CHC5201	550	CHD2465	756	CHO2064	941, 942	CS3632	38
AH4201	597	ARN2103	653	ARN3623	8	ARN5125	244	BBL2150	795	CHA8651	79	CHC1526	428	CHC2461	329	CHC5211	553	CHD2466	756	CHO2065	941	CS3638	40
AH5000	382	ARN2105	651	ARN3638	9	ARN5127	391	BBL2162	804	CHA8654	24	CHC1530	257	CHC2462	329, 330	CHC5212	553, 554	CHD2470	690	CHO2066	943	CS3642	39
AH5002	382	ARN2124	649, 650	ARN3655	9	ARN5128	244	BBL2164	804	CHA8655	21	CHC1535	257	CHC2465	330	CHC5213	553, 554	CHD2472	894	CHO2067	941	CS3646	39
AH5010	331, 332	ARN2125	650	ARN3712	127	ARN5129	263	BBL3003	88	CHA8661	28	CHC1543	314	CHC2530	558	CHC5240	453, 454	CHD2473	894	CHO2084	934	CS3652	40
AH5015	479	ARN2170	651, 917	ARN4000	639, 640	ARN5145	245	BBL3006	51	CHA8666	27	CHC1548	314	CHC2531	557, 558	CHC5245	453, 454	CHD2474	894	CHO2085	931	CS5100	317
AH5210	481	ARN2171	651, 917	ARN4001	640	ARN5170	245	BBL3008	104	CHA8668	21, 22	CHC1550	267, 268	CHC2535	548	CHC5271	258	CHD2550	657	CHO2086	933	JN1002	152
AH5215	421, 422	ARN4003	917	ARN4003	602	ARN5173	247	BBL3023	118	CHA8679	20	CHC1551	268	CHC2536	548	CHC5286	280	CHD2551	657, 658	CHO2087	933	JN2002	691
AH5216	422	ARN2201	697	ARN4004	607	ARN5174	247	BBL3024	109, 110	CHA8670	20	CHC1552	268	CHC3108	543	CHC5287	279, 280	CHD2620	730	CHO2109	936	JN2016	657
ARN1001	185	ARN2202	697	ARN4007	637	ARN5200	564	BBL3030	108	CHA8679	71	CHC1554	327	CHC3109	543	CHC5315	346	CHD2621	730	CHO2110	936	JN2020	770
ARN1002	153, 154	ARN2226	655, 656	ARN4009	637	ARN5201	407, 408	BBL3035	110	CHA8693	19	CHC1559	268	CHC3111	368	CHC5370	313	CHD2705	706	CHO2111	936	JN2030	663
ARN1003	191, 192	ARN2255	885	ARN4010	637	ARN5202	382	BBL3036	109	CHA8694	23, 24	CHC1560	314	CHC3112	367, 368	CHC5373	313	CHD2712	668	CHO2112	935	JN2051	700
ARN1005	175	ARN2260	780	ARN4011	602	ARN5204	351, 352	BBL3070	105, 106	CHA8697	22	CHC1561	305, 306	CHC3310	537	CHC5377	313	CHD2713	668	CHO2113	936	JN2070	691
ARN1006	207, 208	ARN2301																					



Table with 19 columns: BASE CODE, PAGE, BASE CODE, PAGE, BASE CODE, PAGE, BASE CODE, PAGE, BASE CODE, PAGE, BASE CODE, PAGE, BASE CODE, PAGE, BASE CODE, PAGE, BASE CODE, PAGE, BASE CODE, PAGE. Rows list various codes and their corresponding page numbers.

BASE CODE	PAGE	BASE CODE	PAGE	BASE CODE	PAGE	BASE CODE	PAGE	BASE CODE	PAGE	BASE CODE	PAGE
TOB2191	729	TOB3030	61	TOB4220	617	TOB5430	500				
TOB2197	877	TOB3031	61	TOB4290	576	TOB5431	499				
TOB2198	877	TOB3032	107	TOB4291	575	TOB5432	499				
TOB2201	810	TOB3033	107	TOB4294	576	TOB5433	499				
TOB2203	810	TOB3051	56, 99	TOB5000	483, 484	TOB5451	345				
TOB2204	809, 810	TOB3095	72	TOB5002	341	TOB5452	345				
TOB2206	878	TOB3101	113	TOB5003	341, 342	TOB5470	263				
TOB2207	878	TOB3106	114	TOB5004	413, 414	TOB5702	504				
TOB2208	883, 884	TOB3129	54	TOB5005	414	TOB5705	394				
TOB2209	883	TOB3142	129	TOB5007	337	TOB5750	346				
TOB2221	687	TOB3152	83	TOB5008	337, 338	TOB5751	497				
TOB22253	895	TOB3180	99	TOB5009	335	TOB5752	497				
TOB22252	896	TOB3190	131, 132	TOB5010	335	TOB5753	498				
TOB22254	896	TOB3194	112	TOB5011	427	TOB5755	425				
TOB22256	896	TOB3195	64	TOB5012	483	TOB5760	346				
TOB2235	660	TOB3197	131	TOB5013	483						
TOB2236	659, 660	TOB3212	128	TOB5014	450						
TOB2237	660	TOB3222	140	TOB5016	344						
TOB2242	688	TOB3240	69, 70	TOB5017	334						
TOB2272	754	TOB3241	70	TOB5018	333						
TOB2273	754	TOB3260	117	TOB5019	336						
TOB2283	752	TOB3290	133	TOB5024	326						
TOB2284	752	TOB3291	133	TOB5030	563						
TOB2290	796	TOB3362	72	TOB5031	275						
TOB2314	902	TOB3390	98	TOB5032	275						
TOB2315	901	TOB3452	78	TOB5033	275, 276						
TOB2316	902	TOB3504	114	TOB5036	265						
TOB2317	902	TOB3513	129, 130	TOB5042	493, 494						
TOB2318	901	TOB3536	136	TOB5046	344						
TOB2327	753	TOB3613	114	TOB5062	465, 466						
TOB2328	753	TOB3627	69	TOB5063	466						
TOB2330	681	TOB3630	100	TOB5064	466						
TOB2470	660	TOB3631	100	TOB5068	467						
TOB2471	660	TOB3655	31	TOB5069	467						
TOB2502	676	TOB3657	31	TOB5071	467						
TOB2503	676	TOB3710	32	TOB5076	493						
TOB2600	721, 722	TOB3725	141	TOB5089	449						
TOB2604	842	TOB3734	89	TOB5090	449						
TOB2605	842	TOB3735	89	TOB5091	449						
TOB2606	842	TOB3736	113	TOB5097	468						
TOB2620	849	TOB3737	113	TOB5098	468						
TOB2621	849	TOB3804	32	TOB5099	468						
TOB2623	850	TOB3916	59	TOB5112	482						
TOB2630	741	TOB3917	59	TOB5113	482						
TOB2730	688	TOB3932	67	TOB5119	328						
TOB2740	711	TOB3940	63	TOB5150	480, 633						
TOB2741	711, 712	TOB3980	58	TOB5154	495, 496						
TOB2750	698	TOB4000	636	TOB5155	495						
TOB2751	881	TOB4006	635	TOB5156	495						
TOB2753	699	TOB4011	627, 628	TOB5160	480						
TOB2916	667	TOB4013	627, 628	TOB5205	312						
TOB3000	111	TOB4062	622	TOB5206	312						
TOB3001	111	TOB4063	622	TOB52262	501						
TOB3007	117	TOB4130	589, 590	TOB52263	502						
TOB3011	71	TOB4131	590	TOB52264	502						
TOB3014	56	TOB4155	636	TOB52265	502						
TOB3020	56	TOB4203	614	TOB5288	286						
TOB3023	56	TOB4212	641	TOB5290	285, 286						
TOB3026	97	TOB4215	621	TOB5303	293						
TOB3029	54	TOB4216	621	TOB5305	504						



**VISUAL COMFORT & CO.**

22400 NORTHWEST LAKE DRIVE

HOUSTON, TEXAS 77095

713.686.5999

[www.visualcomfort.com](http://www.visualcomfort.com)

© 2019 Visual Comfort of America LLC